

# Shower & Bath Systems

Il termine wellness fa riferimento ad una filosofia di vita che fa del benessere della persona lo scopo primario. CRISTINA rubinetterie interpreta da sempre questo concetto realizzando prodotti di qualità in grado di garantire ai consumatori il massimo benessere. Le docce da esterno in acciaio Inox AISI 316 L sono progettate e realizzate per erogare un getto confortevole ed avvolgente: un vero e proprio dispositivo antistress. Sono infatti semplici e rigorose nelle loro linee progettuali, ma sensuali e coinvolgenti nell'esclusiva modalità di erogazione.

Der Begriff Wellness bezieht sich auf eine Lebensphilosophie, dessen Hauptzweck das Wohlbefinden des Menschen ist. CRISTINA rubinetterie interpretiert seit langer Zeit dieses Konzept mit ihren Qualitätsprodukten, die den Kunden höchstes Wohlbefinden gewährleisten. Die Außenduschen aus Edelstahl AISI 316 L sind so konzipiert und entwickelt, um einen behaglichen und komfortablen Strahl zu bieten: eine echte Vorrichtung gegen Stress. Sie sind einfach und streng in ihrem Design aber sinnlich in der einzigartigen Art der Wasserabgabe.

The term "wellbeing" refers to a lifestyle philosophy which put people's health at the center. CRISTINA rubinetterie deeply believes in this concept and continues manufacturing high quality products. The company's biggest goal is to focus on costumers' comfort and health. The outdoor showers in AISI 316 L Inox steel features water flow, which is designed to be comfortable and able to ensure people great moments of relax. Essential and rigorous in their design, these styles incorporate a sensual, charming water shower effect which is unique.

Le terme Wellness fait référence à une philosophie de vie qui fait du bien-être de la personne son besoin premier. CRISTINA rubinetterie traduit depuis toujours ce concept en réalisant des produits de qualité, et est ainsi en mesure de garantir le maximum de bien-être au consommateur. Les douches exterieures en Inox AISI 316 L sont conçues et réalisées avec un débit confortable et enveloppant, un vrai dispositif anti-stress. Elles sont simples et épurées, elles disposent d'un jet de pluie unique et sensuel.

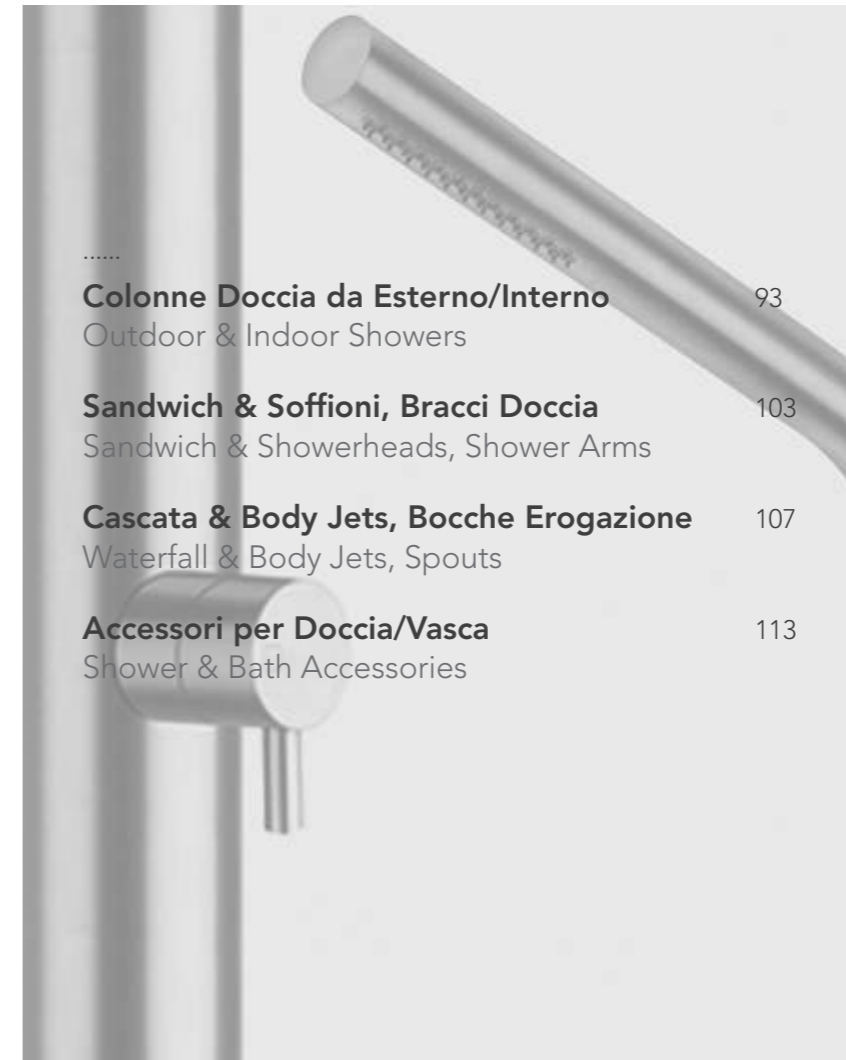

.....	
<b>Colonne Doccia da Esterno/Interno</b>	93
Outdoor & Indoor Showers	
<b>Sandwich &amp; Soffioni, Bracci Doccia</b>	103
Sandwich & Showerheads, Shower Arms	
<b>Cascata &amp; Body Jets, Bocche Erogazione</b>	107
Waterfall & Body Jets, Spouts	
<b>Accessori per Doccia/Vasca</b>	113
Shower & Bath Accessories	

*Colonne Doccia  
da Esterno/  
Interno  
Outdoor  
& Indoor Showers*



WX 511

Basamento per funzionamento con miscelatore  
Concealed base for 2 inlets  
Sockel für Mischfunktion  
Base pour fonctionnement avec mélangeur



Basamento per funzionamento monoacqua  
Concealed base for 1 inlets  
Sockel für Kaltwasserfunktion  
Base pour fonctionnement pour mono fluide



COLONNE DOCCIA DA ESTERNO/INTERNO / OUTDOOR & INDOOR SHOWERS

AISI 316 L

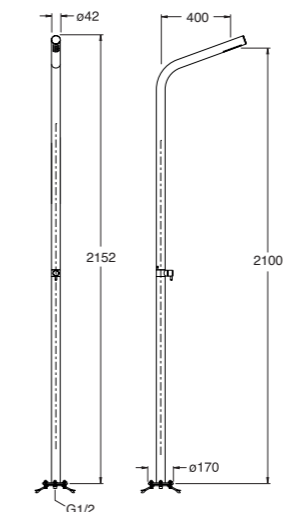

WX 511 28 Ø 42mm

Colonna doccia da esterno/interno a pavimento con rubinetto d'arresto monoacqua, sistema di fissaggio e alimentazione a terra, e sistema di svuotamento acqua antigelo

Bodenstehende Innen- und Außendusche mit Kaltwasseranschluss, Absperrventil, Bodenbefestigung, und integriertem Entleerungssystem (frostsicher)

Outdoor/indoor floor mounted shower column with one-water stopcock, ground fixing and water supply system, and antifreeze emptying water system

Colonne de douche extérieur/intérieur au sol avec robinet d'arrêt mono fluide, système de fixation et alimentation au sol et système d'évacuation de l'eau intégré

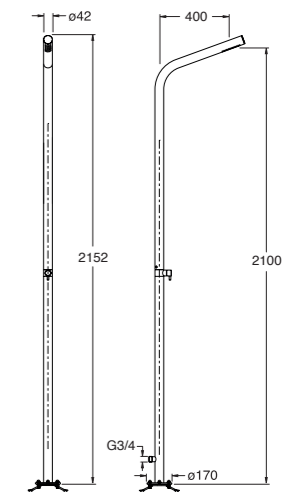
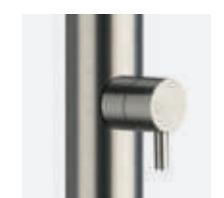
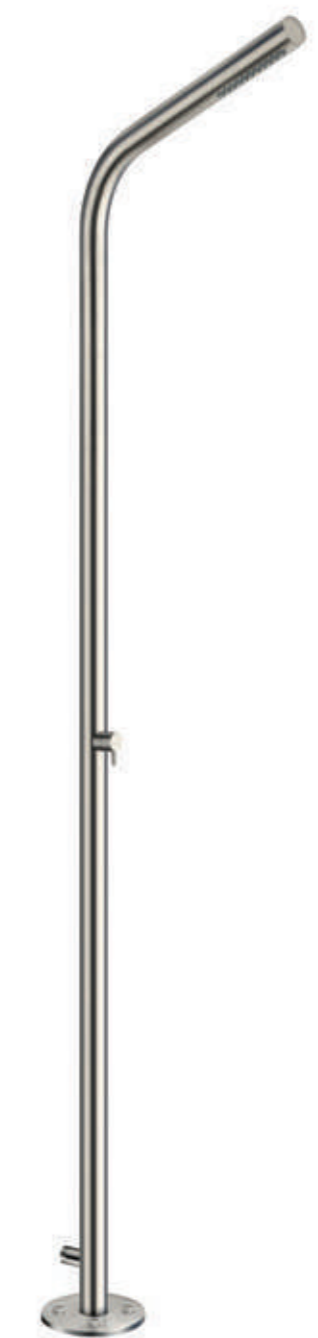

WX 509 28 Ø 42mm

Colonna doccia da esterno/interno a pavimento con rubinetto d'arresto monoacqua, sistema di fissaggio a terra e alimentazione esterna.

Bodenstehende Innen- und Außendusche mit Kaltwasseranschluss, Absperrventil, Bodenbefestigung und externer Wasserversorgung

Outdoor/indoor floor mounted shower column with one-water stopcock, ground fixing system and external water supply.

Colonne de douche extérieur/intérieur au sol avec robinet d'arrêt mono fluide, système de fixation au sol et alimentation externe



AISI 316 L

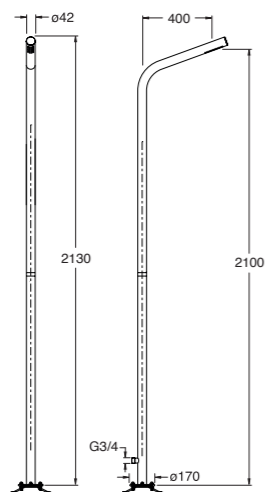
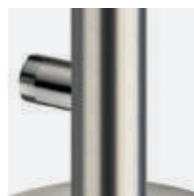

**WX 508 28** Ø 42mm

Colonna doccia da esterno/interno a pavimento monoacqua con sistema di fissaggio a terra e alimentazione esterna, da abbinare a miscelatore

Bodenstehende Innen- und Außendusche mit Kaltwasseranschluss, Bodenbefestigung und externer Wasserversorgung. Mit einem Mischer zu kombinieren

Outdoor/indoor floor mounted one-water shower column, ground fixing system and external water supply. To combine with a mixer

Colonne de douche extérieur/intérieur au sol mono fluide, système de fixation au sol et alimentation externe. A associer avec un mitigeur



**WX 512 28** Ø 42mm

Colonna doccia da esterno/interno a pavimento monoacqua con sistema di fissaggio e alimentazione a terra, e sistema di svuotamento acqua antigelo. Da abbinare a miscelatore

Bodenstehende Innen- und Außendusche mit Kaltwasseranschluss, Bodenbefestigung und integriertem Entleerungssystem (frostsicher). Mit einem Mischer zu kombinieren

Outdoor/indoor floor mounted one-water shower column, ground fixing and water supply system, and antifreeze emptying water system. To combine with a mixer

Colonne de douche extérieur/intérieur au sol mono fluide, système de fixation et alimentation au sol et système d'évacuation de l'eau intégré. A associer avec un mitigeur

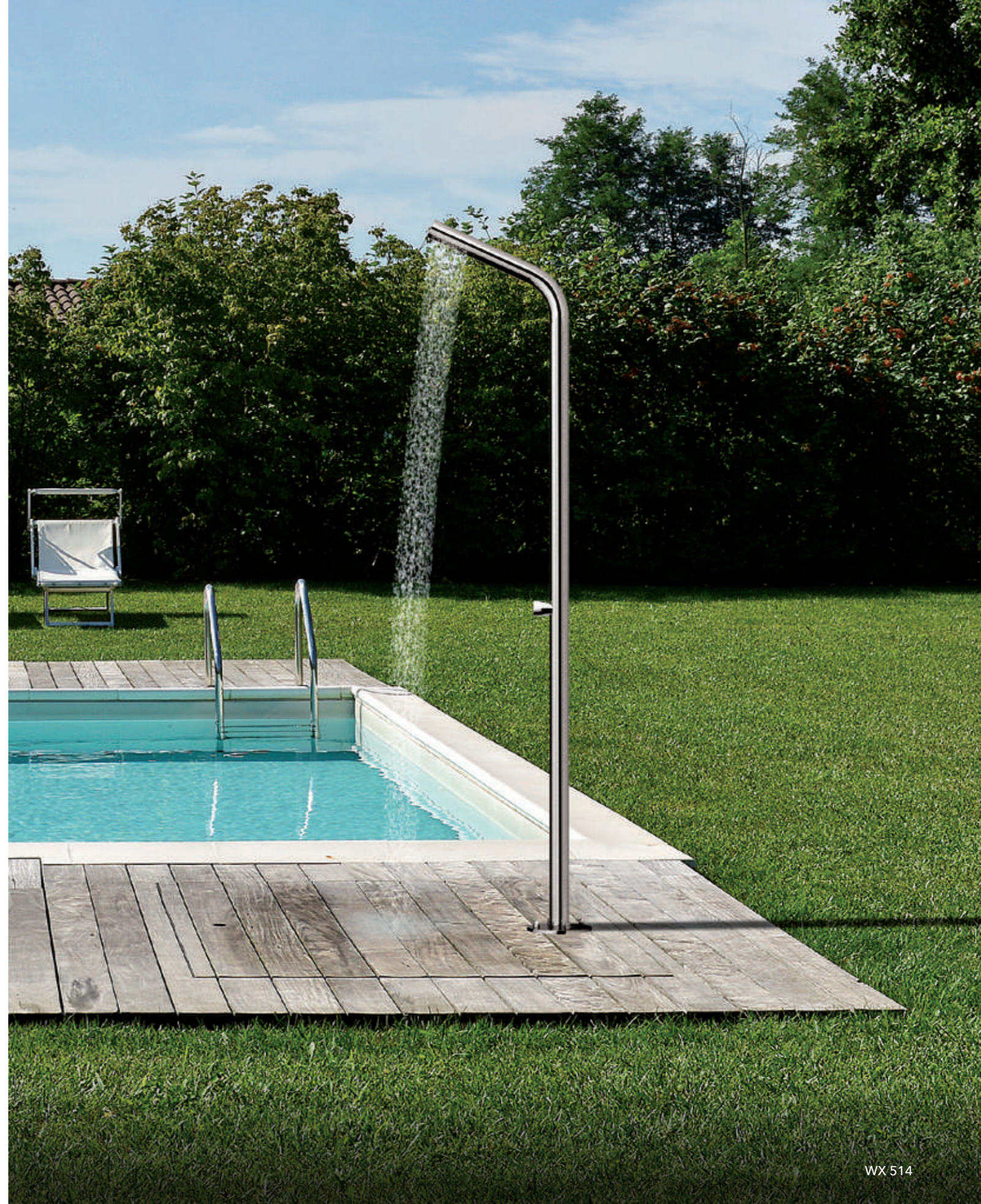



AISI 316 L

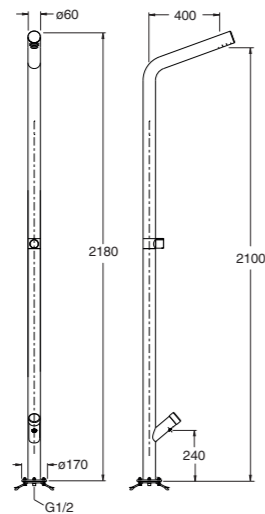
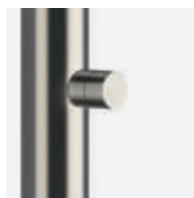

**WX 515 28** Ø 60 mm

Colonna doccia da esterno/interno a pavimento con rubinetto temporizzato monoacqua, getto lava piedi temporizzato, sistema di fissaggio e alimentazione a terra, e sistema di svuotamento acqua antigelo

Outdoor/indoor floor mounted shower column with one-water self-closing tap, feet washer self-closing jet, ground fixing and water supply system, and antifreeze emptying water system

Bodenstehende Innen- und Außendusche mit Kaltwasseranschluss, Selbstschlusskartusche für Kopf- und Fußbetätigung, Bodenbefestigung und integriertem Entleerungssystem (frostsicher)

Colonne de douche extérieur/intérieur au sol avec robinet temporisé mono fluide, jet temporisé pour les pieds, système de fixation et alimentation au sol et système d'évacuation de l'eau intégré

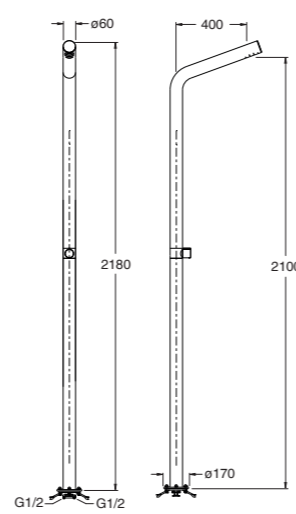

**WX 514 28** Ø 60 mm

Colonna doccia da esterno/interno a pavimento con miscelazione progressiva, sistema di fissaggio e alimentazione a terra, e sistema di svuotamento acqua antigelo

Outdoor/indoor floor mounted shower column with progressive mixing valve, ground fixing and water supply system, and antifreeze emptying water system

Bodenstehende Innen- und Außendusche mit progressiver Kartusche, Bodenbefestigung und integriertem Entleerungssystem (frostsicher)

Colonne de douche extérieur/intérieur au sol cartouche progressive, système de fixation et alimentation au sol et système d'évacuation de l'eau intégré



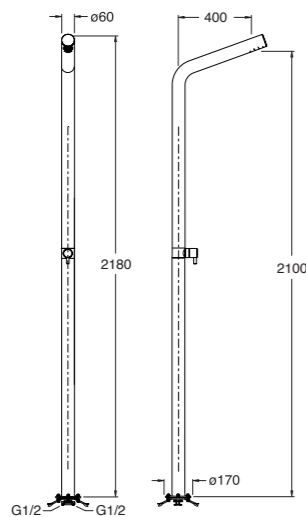
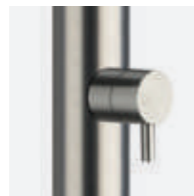

**WX 524 28** Ø 60 mm

Colonna doccia da esterno/interno a pavimento con miscelazione monocomando, sistema di fissaggio e alimentazione a terra, e sistema di svuotamento acqua antigelo

Outdoor/indoor floor mounted shower column with mixing valve, ground fixing and water supply system, and antifreeze emptying water system

Bodenstehende Innen- und Außendusche mit Einhandmischer, Bodenbefestigung und integriertem Entleerungssystem (frostsicher)

Colonne de douche extérieur/intérieur au sol avec mitigeur, système de fixation et alimentation au sol et système d'évacuation de l'eau intégré

**WX 513 28** Ø 60 mm

Colonna doccia da esterno/interno a pavimento monoacqua con sistema di fissaggio e alimentazione a terra, e sistema di svuotamento acqua antigelo. Da abbinare a miscelatore

Outdoor/indoor floor mounted one-water shower column, ground fixing and water supply system, and antifreeze emptying water system. To combine with a mixer

Bodenstehende Innen- und Außendusche mit Kaltwasseranschluss, Bodenbefestigung und integriertem Entleerungssystem (frostsicher). Mit einem Mischer zu kombinieren

Colonne de douche extérieur/intérieur au sol mono fluide, système de fixation et alimentation au sol et système d'évacuation de l'eau intégré. A associer avec un mitigeur

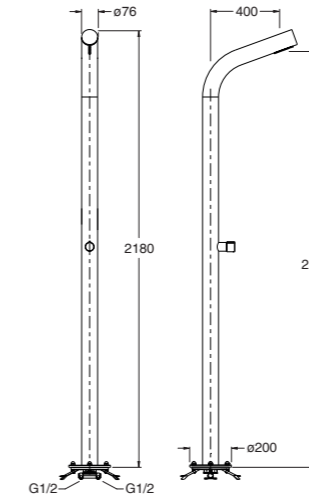
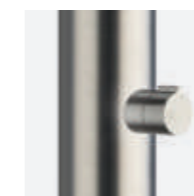

**WX 517 28** Ø 76 mm

Colonna doccia da esterno/interno a pavimento con miscelazione progressiva, sistema di fissaggio e alimentazione a terra, e sistema di svuotamento acqua antigelo

Outdoor/indoor floor mounted shower column with progressive mixing valve, ground fixing and water supply system, and antifreeze emptying water system

Bodenstehende Innen- und Außendusche mit progressiver Kartusche, Bodenbefestigung und integriertem Entleerungssystem (frostsicher)

Colonne de douche extérieur/intérieur au sol cartouche progressive, système de fixation et alimentation au sol et système d'évacuation de l'eau intégré

**WX 527 28** Ø 76 mm

Colonna doccia da esterno/interno a pavimento con miscelazione monocomando, sistema di fissaggio e alimentazione a terra, e sistema di svuotamento acqua antigelo

Outdoor/indoor floor mounted shower column with mixing valve, ground fixing and water supply system, and antifreeze emptying water system

Bodenstehende Innen- und Außendusche mit Einhandmischer, Bodenbefestigung und integriertem Entleerungssystem (frostsicher)

Colonne de douche extérieur/intérieur au sol avec mitigeur, système de fixation et alimentation au sol et système d'évacuation de l'eau intégré



WX 510



WX 510

COLONNE DOCCIA DA ESTERNO/INTERNO / OUTDOOR & INDOOR SHOWERS

AISI 316 L 

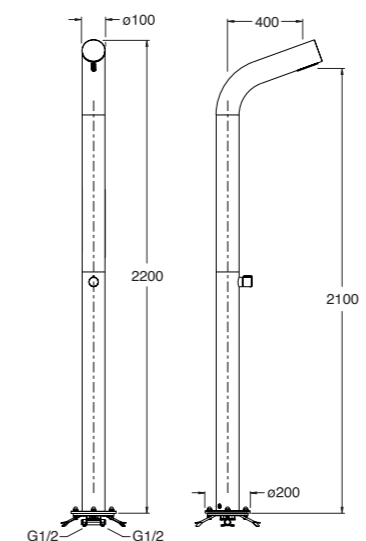
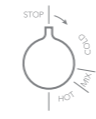

WX 510 28 Ø 100 mm

Colonna doccia da esterno/interno a pavimento con miscelazione progressiva, sistema di fissaggio e alimentazione a terra, e sistema di svuotamento acqua antigelo

Bodenstehende Innen- und Außendusche mit progressiver Kartusche, Bodenbefestigung und integriertem Entleerungssystem (frostsicher)

Outdoor/indoor floor mounted shower column with progressive mixing valve, ground fixing and water supply system, and antifreeze emptying water system

Colonne de douche extérieure/intérieur au sol cartouche progressive, système de fixation et alimentation au sol et système d'évacuation de l'eau intégré

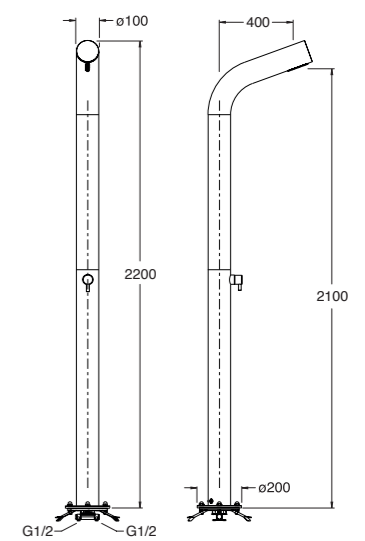

WX 520 28 Ø 100 mm

Colonna doccia da esterno/interno a pavimento con miscelazione monocomando, sistema di fissaggio e alimentazione a terra, e sistema di svuotamento acqua antigelo

Bodenstehende Innen- und Außendusche mit Einhandmischer, Bodenbefestigung und integriertem Entleerungssystem (frostsicher)

Outdoor/indoor floor mounted shower column with mixing valve, ground fixing and water supply system, and antifreeze emptying water system

Colonne de douche extérieure/intérieur au sol avec mitigeur, système de fixation et alimentation au sol et système d'évacuation de l'eau intégré

*Sandwich & Soffioni, Bracci Doccia*  
*Sandwich & Showerheads, Shower Arms*

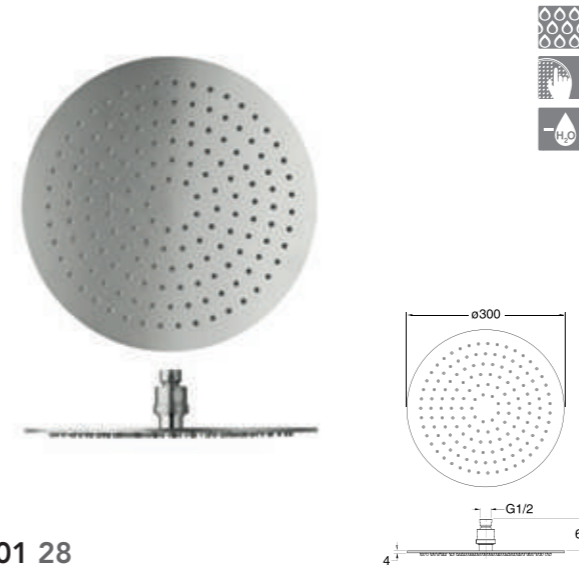

**PD 001 28**

Soffione anticalcare SANDWICH PLUS ø 30 cm.

ø 30 cm SANDWICH PLUS anti-lime showerhead.

Kopfbrause SANDWICH PLUS ø 30 cm mit Antikalk-System

Pomme de douche anticalcaire SANDWICH PLUS ø 30 cm

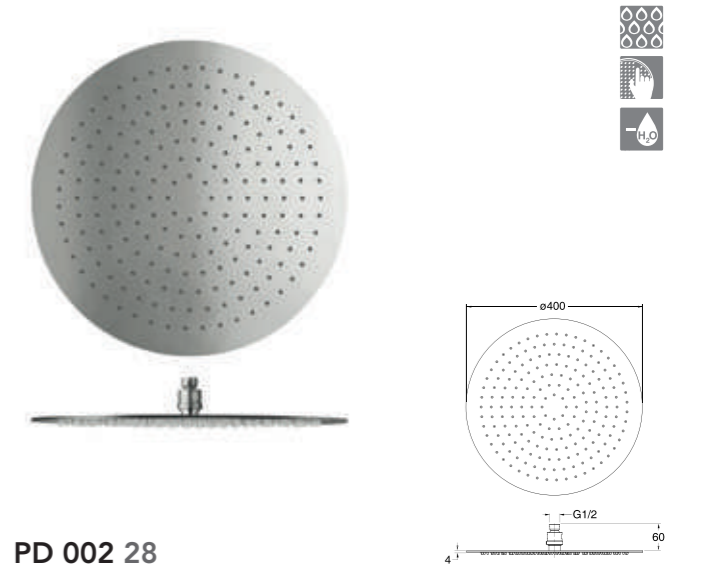

**PD 002 28**

Soffione anticalcare SANDWICH PLUS ø 40 cm.

ø 40 cm SANDWICH PLUS anti-lime showerhead.

Kopfbrause SANDWICH PLUS ø 40 cm mit Antikalk-System

Pomme de douche anticalcaire SANDWICH PLUS ø 40 cm

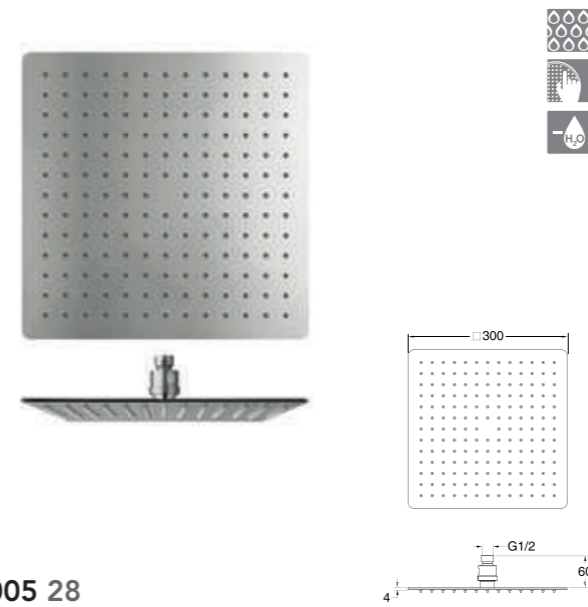

**PD 005 28**

Soffione anticalcare SANDWICH PLUS quadrato 30 x 30 cm

30 x 30 cm square SANDWICH PLUS anti-lime showerhead

Kopfbrause SANDWICH PLUS quadratisch 30 x 30 cm mit Antikalk-System

Pomme de douche anticalcaire SANDWICH PLUS carrée 30 x 30 cm

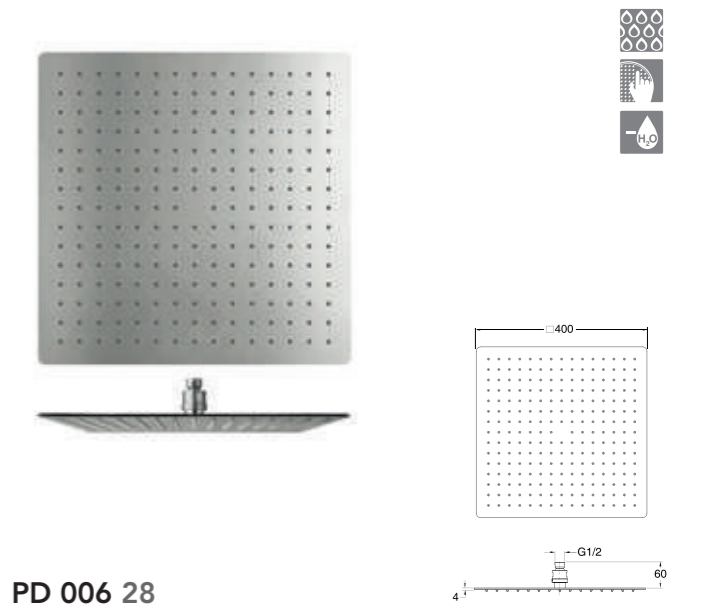

**PD 006 28**

Soffione anticalcare SANDWICH PLUS quadrato 40 x 40 cm

40 x 40 cm square SANDWICH PLUS anti-lime showerhead

Kopfbrause SANDWICH PLUS quadratisch 40 x 40 cm mit Antikalk-System

Pomme de douche anticalcaire SANDWICH PLUS carrée 40 x 40 cm

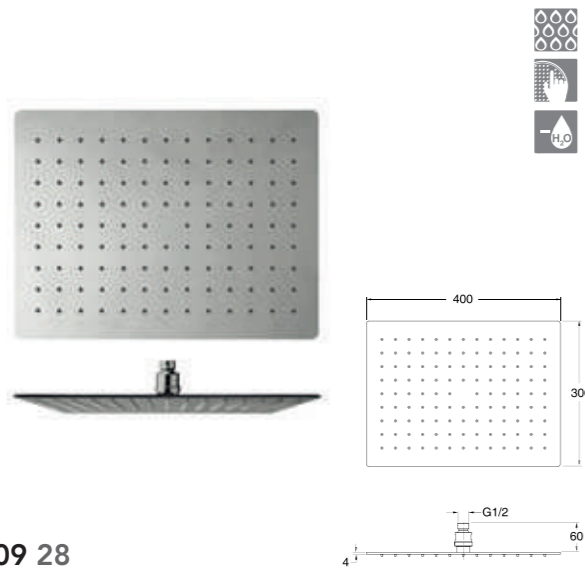

**PD 009 28**

Soffione anticalcare SANDWICH PLUS rettangolare 30x40 cm.

30 x 40 rectangular SANDWICH PLUS anti-lime showerhead.

Kopfbrause SANDWICH PLUS rechteckig 30 x 40 cm mit Antikalk-System

Pomme de douche anticalcaire SANDWICH PLUS rectangulaire 30 x 40 cm

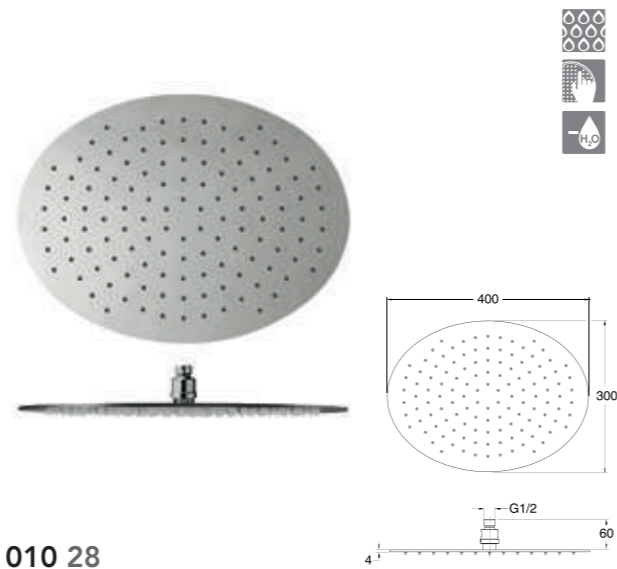

**PD 010 28**

Soffione anticalcare SANDWICH PLUS ovale 30 x 40 cm.

30 x 40 oval SANDWICH PLUS anti-lime showerhead.

Kopfbrause SANDWICH PLUS oval 30 x 40 cm mit Antikalk-System

Pomme de douche anticalcaire SANDWICH PLUS ovale 30 x 40 cm



**PD 567 28**

Braccio doccia da 30 cm per soffione.

Wandbrausearm 30 cm für Kopfbrause

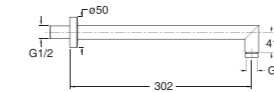

30 cm wall shower arm.

Bras 30 cm pour pomme de douche



**PD 573 28**

Braccio doccia da 35 cm per soffione.

Wandbrausearm 35 cm für Kopfbrause

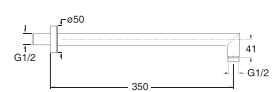

35 cm wall shower arm.

Bras 35 cm pour pomme de douche

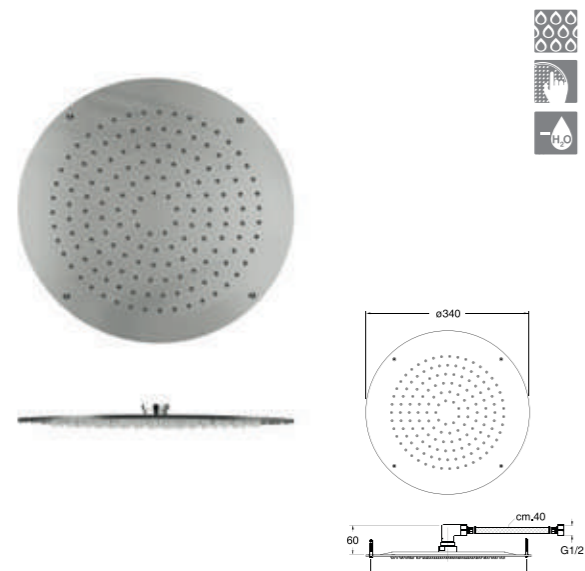

**PD 360 28**

Soffione anticalcare SANDWICH SPECIAL ø 34 cm per fissaggio a soffitto con staffe di allineamento e flessibile di collegamento.

Ceiling mounting ø 34 cm SANDWICH SPECIAL anti-lime showerhead with setting frame and flexible connection.

Kopfbrause SANDWICH SPECIAL ø 34 cm mit Antikalk-System für Deckenmontage mit Montageschienen für die Ausrichtung und mit Verbindungsschlauch

Pomme de douche anticalcaire SANDWICH SPECIAL ø 34 cm avec fixation au plafond avec cadre d'alignement et flexibles de connexion

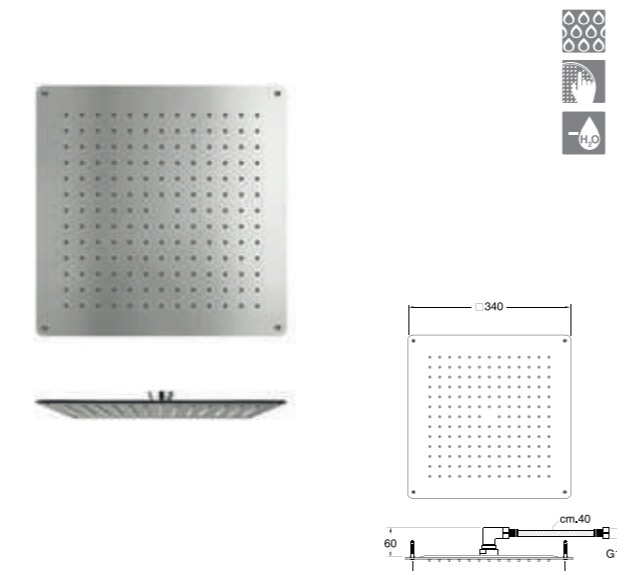

**PD 362 28**

Soffione anticalcare SANDWICH SPECIAL quadrato 34 x 34 cm per fissaggio a soffitto con staffe di allineamento e flessibile di collegamento.

Ceiling mounting 34 x 34 cm square SANDWICH SPECIAL anti-lime showerhead with setting frame and flexible connection.

Kopfbrause SANDWICH SPECIAL quadratisch 34 x 34 cm mit Antikalk-System für Deckenmontage mit Montageschienen für die Ausrichtung und mit Verbindungsschlauch

Pomme de douche anticalcaire SANDWICH SPECIAL carrée 34 x 34 cm avec fixation au plafond avec cadre d'alignement et flexibles de connexion



**PD 416 28**

Tubo a soffitto da 10 cm per soffione.

Deckenanschluss-Stück 10 cm für Kopfbrause

10 cm ceiling shower arm.

Support plafond 10 cm pour pomme de douche

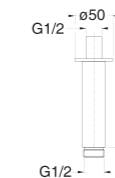



# Cascata & Body Jets, Bocche Erogazione

## Waterfall & Body Jets, Spouts

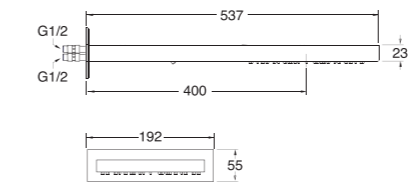

**PD 384 28**

Soffione anticalcare con erogazione a cascata integrata e sistema di fissaggio a parete

Wandkopfbräuse mit Antikalk-System und integrierter Wasserfall Funktion

Anti-lime showerhead with built-in waterfall flow and wall mounting system

Pomme de tête anticalcaire avec sortie cascade intégrée et système de fixation dans le mur

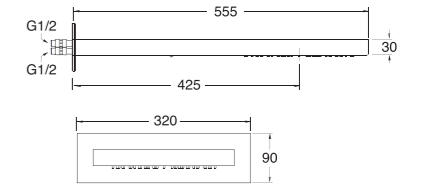

**PD 382 28**

Soffione anticalcare con erogazione a cascata integrata e sistema di fissaggio a parete

Wandkopfbräuse mit Antikalk-System und integrierter Wasserfall Funktion

Anti-lime showerhead with built-in waterfall flow and wall mounting system

Pomme de tête anticalcaire avec sortie cascade intégrée et système de fixation dans le mur

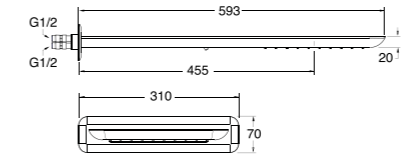

**PD 387 28**

Soffione anticalcare con erogazione a cascata integrata e sistema di fissaggio a parete

Wandkopfbräuse mit Antikalk-System und integrierter Wasserfall Funktion

Anti-lime showerhead with built-in waterfall flow and wall mounting system

Pomme de tête anticalcaire avec sortie cascade intégrée et système de fixation dans le mur

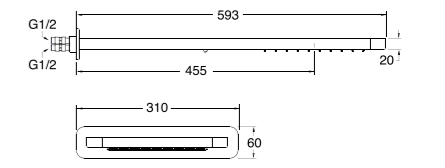

**PD 386 28**

Soffione anticalcare con erogazione a cascata integrata e sistema di fissaggio a parete

Wandkopfbräuse mit Antikalk-System und integrierter Wasserfall Funktion

Anti-lime showerhead with built-in waterfall flow and wall mounting system

Pomme de tête anticalcaire avec sortie cascade intégrée et système de fixation dans le mur

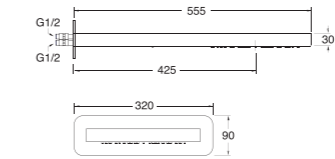

**PD 383 28**

Soffione anticalcare con erogazione a cascata integrata e sistema di fissaggio a parete  
  
Wandkopfbrause mit Antikalk-System und integrierter Wasserfall Funktion

Anti-lime showerhead with built-in waterfall flow and wall mounting system  
  
Pomme de tete anticalcaire avec sortie cascade intégrée et système de fixation dans le mur

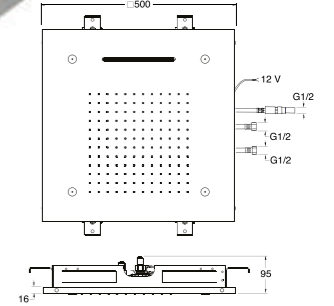

**PD 390 28**

Soffione anticalcare quadrato 50 x 50 cm con illuminazione a 11 programmi, erogazione a cascata integrata, nebulizzatore e fissaggio a soffitto  
  
Decken-Kopfbrause quadratisch 50 x 50 cm mit Beleuchtung mit 11 Programmen, integrierter Wasserfall Funktion und Vernebelung Funktion

50 x 50 cm square anti-lime showerhead with 11 programmes lighting, built-in waterfall flow, spray nozzle and ceiling mounting system  
  
Pomme de tete anticalcaire carrée de 50 cm avec illumination incorporée avec 16 programmes, avec sortie cascade intégrée, vapeur d'eau et fixation au plafond

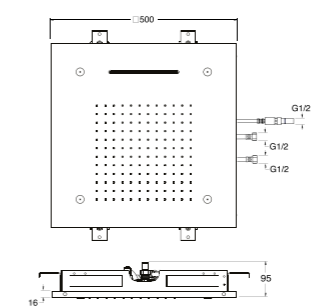

**PD 380 28**

Soffione anticalcare quadrato 50 x 50 cm con erogazione a cascata integrata, nebulizzatore e fissaggio a soffitto  
  
Decken-Kopfbrause quadratisch 50 x 50 cm mit Antikalk-System, integrierter Wasserfall Funktion und Vernebelung Funktion

50 x 50 cm square anti-lime showerhead with built-in waterfall flow, spray nozzle and ceiling mounting system  
  
Pomme de tete anticalcaire carrée de 50 cm avec sortie cascade intégrée et vaporisateur et fixation dans le plafond

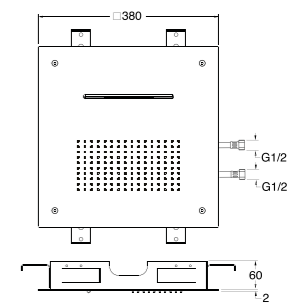

**PD 385 28**

Soffione anticalcare quadrato 38 x 38 cm con erogazione a cascata integrata e fissaggio a soffitto  
  
Decken-Kopfbrause quadratisch 38 x 38 cm mit Antikalk-System, integrierter Wasserfall Funktion

38 x 38 cm square anti-lime showerhead with built-in waterfall flow and ceiling mounting system  
  
Pomme de tete anticalcaire carrée de 38 cm avec sortie cascade intégrée avec fixation au plafond

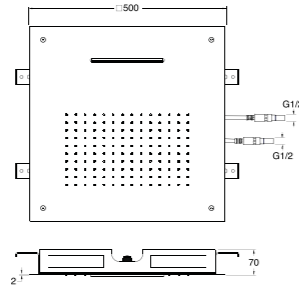

**PD 381 28**

Soffione anticalcare quadrato 50 x 50 cm con erogazione a cascata integrata e fissaggio a soffitto

50 x 50 cm square anti-lime showerhead with built-in waterfall flow and ceiling mounting system

Decken-Kopfbrause quadratisch 50 x 50 cm mit Antikalk-System, integrierter Wasserfall Funktion

Pomme de tête anticalcaire carrée de 50 cm avec sortie cascade intégrée avec fixation au plafond

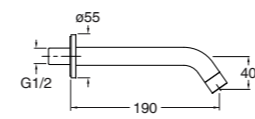

**PD 566 28**

Bocca erogazione incasso da 1/2"

1/2" wall mounted spout

Wanneneinlauf 1/2"

Bec de remplissage encastré 1/2"

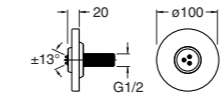

**XX 833 28**

Set da esterno per soffione anticalcare body-jet CS 705 - CS 706 - CS 707

Anti-lime body jet external parts for CS 705 - CS 706 - CS 707

Fertigmontageset Seitenbrause mit Antikalk-System für Einbaukörper CS 705 - CS 706 - CS 707

Façade externe pour buse hydromassante pour mécanisme CS 705 - CS 706 - CS 707

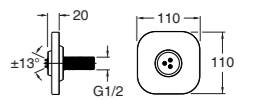

**XX 633 28**

Set da esterno per soffione anticalcare body-jet CS 705 - CS 706 - CS 707

Anti-lime body jet external parts for CS 705 - CS 706 - CS 707

Fertigmontageset Seitenbrause mit Antikalk-System für Einbaukörper CS 705 - CS 706 - CS 707

Façade externe pour buse hydromassante pour mécanisme CS 705 - CS 706 - CS 707

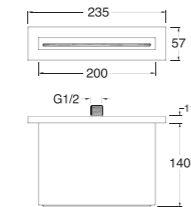

**BD 321 28**

Bocca erogazione a cascata da 20 cm per parete

20 cm wall mounting waterfall spout

Auslauf 20 cm Wandmontage

Bec mural cascade 20 cm

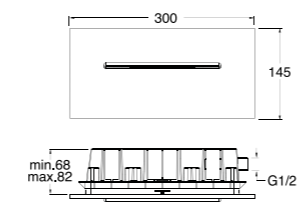

**BD 320 28**

Bocca erogazione a cascata da 20 cm per parete

20 cm wall mounting waterfall spout

Auslauf 20 cm Wandmontage

Bec mural cascade 20 cm

*Accessori per  
Doccia/Vasca  
Shower & Bath  
Accessories*



PD 439

ACCESSORI PER DOCCIA E VASCA / SHOWER & BATH ACCESSORIES

AISI 316 L 

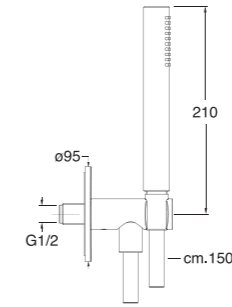

**PD 439 28**

Supporto esterno con presa acqua, doccetta anticalcare e flessibile LONG LIFE

Wall bracket with water supply, LONG LIFE flexible hose and anti-lime hand shower

Wannen-Brause-Set mit Wandanschlussbogen, Handbrause mit Antikalk-System und Brauseschlauch LONG LIFE

Support extérieur avec prise d'eau, douchette anticalcaire et flexible LONG LIFE

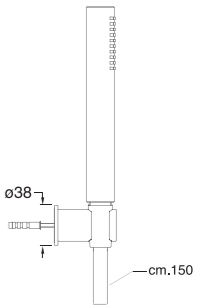

**PD 650 28**

Supporto esterno fisso con doccetta anticalcare e flessibile LONG LIFE

Fixed wall bracket with LONG LIFE flexible hose and anti-lime hand shower

Wannen-Brause-Set ohne Wandanschlussbogen mit Handbrause mit Antikalk-System und Brauseschlauch LONG LIFE

Support extérieur fixe avec douchette anticalcaire et flexible LONG LIFE

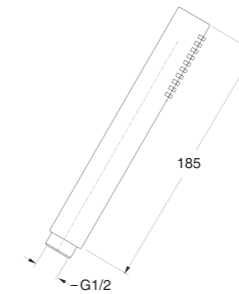

**PD 115 28**

Doccetta anticalcare

Anti-lime hand shower

Handbrause mit Antikalk-System

Douchette anticalcaire

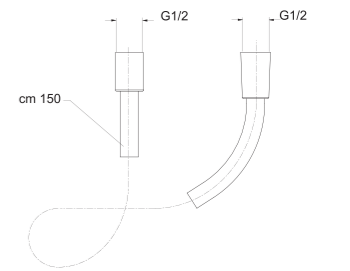

**PD 051 28**

Flessibile LONG LIFE da 150 cm 1/2"x 1/2" girevole

150 cm 1/2"x 1/2" swivel LONG LIFE flexible hose

Brauseschlauch LONG LIFE 150 cm 1/2" x 1/2" verdrehsicher

Flexible LONG LIFE 150 cm 1/2" x 1/2" écrou tournant

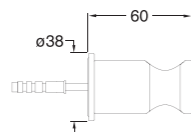

**PD 449 28**

Supporto esterno porta doccetta fisso

Fixed wall bracket for hand shower

Wandbrausehalter

Support extérieur fixe pour douchette

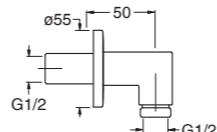

**PD 463 28**

Preso acqua a parete da 1/2"

1/2" wall outlet

Wandanschlussbogen 1/2"

Prise d'eau 1/2"

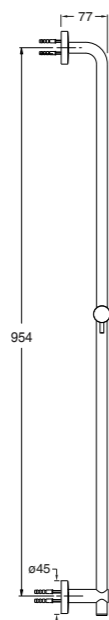

**PD 172 28**

Asta saliscendi da 95 cm con supporto scorrevole

95 cm sliding bar with slide rail

Brausewandstange 95 cm mit Gleitschieber

Barre de douche 95 cm avec curseur réglable

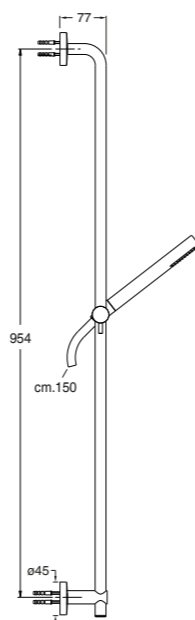

**PD 174 28**

Asta saliscendi da 95 cm con flessibile LONG LIFE e doccetta anticalcare

95 cm sliding bar with LONG LIFE flexible hose and anti-lime hand shower

Brausegarnitur mit Brausestange 95 cm, Brauseschlauch LONG LIFE und Handbrause mit Antikalk-System

Barre de douche 95 cm avec flexible LONG LIFE et douchette anticalcaire

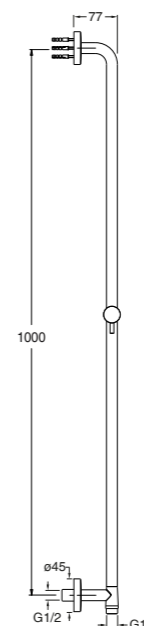

**PD 175 28**

Asta saliscendi da 100 cm con presa acqua e supporto scorrevole

100 cm sliding bar with wall outlet and slide rail

Brausewandstange 100 cm mit Wandanschlussbogen und Gleitschieber

Barre de douche 100 cm avec prise d'eau et curseur réglable

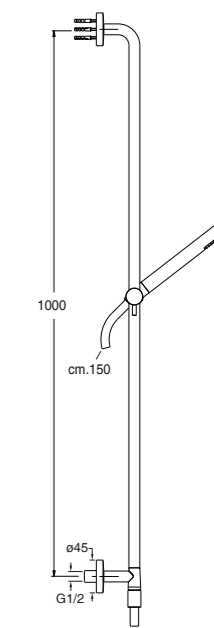

**PD 177 28**

Asta saliscendi da 100 cm con presa acqua, flessibile LONG LIFE e doccetta anticalcare

100 cm sliding bar with wall outlet, LONG LIFE flexible hose and anti-lime hand shower

Brausegarnitur mit Brausestange 100 cm mit Wandanschlussbogen, Brauseschlauch LONG LIFE und Handbrause mit Antikalk-System

Barre de douche 100 cm avec prise d'eau, flexible LONG LIFE et douchette anticalcaire

# *Kitchen Lines*

CRISTINA porta in cucina il piacere dell'inox. Abbina funzionalità ed estetica contemporanea e ottiene un prodotto solido ed eterno.

CRISTINA bringt die Freude vom Edelstahl in der Küche. Sie vereinigt Funktionalität und moderne Ästhetik und stellt ein solides und nachhaltiges Produkt her.

CRISTINA introduces the pleasure of stainless combines with functionality and aesthetics for a virtually everlasting product.

CRISTINA propose pour la cuisine le plaisir de l'inox. La gamme allie fonctionnel et esthétique contemporaine et elle obtient un produit solide et éternel.





KX 525

CUCINA / KITCHEN

AISI 316 L 

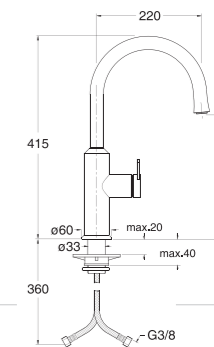

**KX 525 28**

Miscelatore monocomando con leva laterale destra per cucina

Einhand-Mischbatterie für die Küche, Hebel seitlich rechts

Single lever kitchen mixer with right side lever

Mitigeur monocommande pour cuisine avec manette latérale droite



KX 530

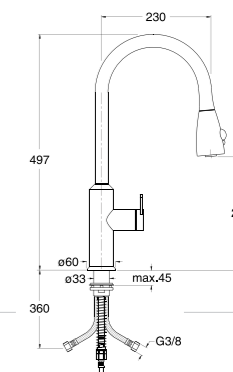

**KX 530 28**

Miscelatore monocomando per cucina con leva laterale destra e doccetta estraibile

Einhand-Mischbatterie für die Küche, mit ausziehbarer Brause, Hebel seitlich rechts

Single lever kitchen mixer with right side lever and pull-out spray

Mitigeur monocommande pour cuisine avec manette latérale droite et douchette amovible



KX 515

CUCINA / KITCHEN

AISI 316 L 

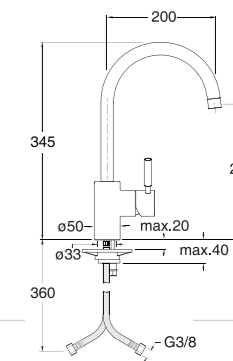

**KX 515 28**

Miscelatore monocomando con  
leva laterale destra per cucina

Single lever kitchen  
mixer with right side lever

Einhand-Mischbatterie für die  
Küche, Hebel seitlich rechts

Mitigeur monocommande pour  
cuisine avec manette latérale  
droite



KX 462

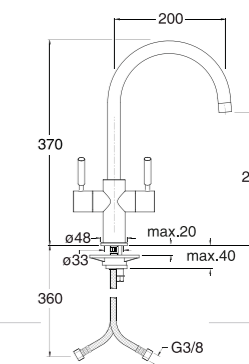

**KX 462 28**

Miscelatore bicomando  
per cucina

Dual lever  
kitchen mixer

Zweigriff-Mischbatterie für die  
Küche

Melangeur pour cuisine





KX 570

CUCINA / KITCHEN

AISI 316 L 

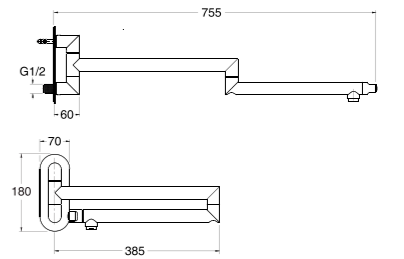

**KX 570 28**

Rubinetto acqua singola  
per cucina a muro

Küchen Standventil für  
Wandmontage

Wall mounted pot  
filler kitchen faucet

Robinet mural 1 eau pour cuisine



KX 570



KX 570

# ENJOY WITH OUR ALPHABET



AE



AR



BE



BO

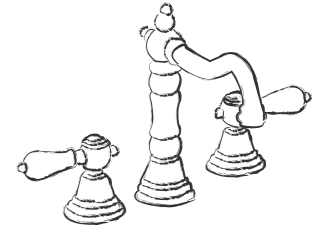

CL / CK



CN



DE



DI



EM



EP

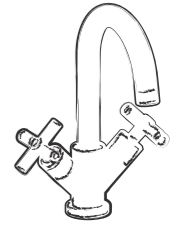

EV



FN



GE

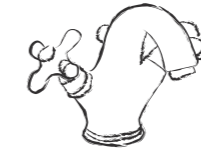

IM



IX



KG

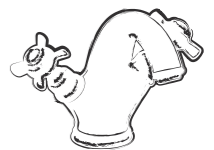

LD

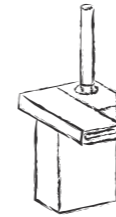

MD



ND



OG



2P

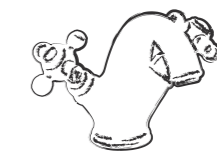

PG



PM / PX



QM



QE



QS



Q5

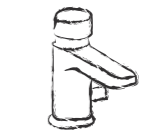

QT



RN



RU



RX



TO



TV



UC / UX



**Credits:**

**Art Direction:**  
CRISTINA rubinetterie

**Photographs:**  
Infrarossi

Ruy Teixeira  
Gian Paolo Giromini  
Graphic Designer

**Print:**  
Testori Tipolitografia

**Special thanks to:**

Antonio Lupi,  
Devon & Devon,  
Teuco Guzzini,  
Ceramica Catalano,  
AB Cucine, CDE srl



**CRISTINA rubinetterie**  
via Fava, 56  
28024 Gozzano (NO) - Italy  
Tel +39 0322 9545  
Fax +39 0322 956556  
info@cristinagroup.com  
crisinarubinetterie.com

**Showroom**  
via Pontaccio, 8/10  
20121 Milano  
Tel +39 02 83970732  
cristinabrera@cristinagroup.com



L'azienda si riserva il diritto di apportare modifiche che riterrà opportune, utili a migliorare la funzionalità e l'estetica dei propri prodotti senza preavviso.  
The company reserves the right to make any appropriate modifications to improve functionality and design of its products without notice.  
Die CRISTINA behält sich vor, Änderungen ohne Benachrichtigung vorzunehmen, um die Funktion und das Design ihrer Produkte zu verbessern.  
L'entreprise se réserve le droit d'apporter modifications retenues utiles pour l'amélioration de la fonctionnalité et de l'esthétique de ses propres produits sans aucun préavis.



CRISTINA



CRISTINA

