

Bathroom Lines & accessories

Il bagno Inox CRISTINA offre una gamma completa di proposte raffinate, che coniugano la qualità dell'inox e il design italiano. Le linee iX, RX, PiX e UniX sono caratterizzate da linee minimaliste e contemporanee. Il know how del brand unito all'utilizzo delle migliori tecnologie rende unico l'ambiente bagno.

Das Bad CRISTINA Inox bietet eine komplette Palette an raffinierten Produkten, die Edelstahlqualität mit italienischem Design kombinieren. Die Linien iX, RX, PiX und UniX haben ein minimalistisches und modernes Design. Das Know-how der Marke zusammen mit der Verwendung der besten Technologien machen das Bad einzigartig.

CRISTINA offers a full range of sophisticated proposals. Combining high quality of stainless steel and Italian design. iX, RX, PiX and UniX have minimalist design and they fit properly in a contemporary location. The know how of the brand merged into excellent technologies makes the bathroom unique.

La gamme pour le bain Inox CRISTINA, propose une offre complète d'articles raffinés, qui combine la qualité de l'inox et le design italien. Les lignes iX, RX, PiX et UniX sont minimalistes et contemporaines. Le savoir-faire de la marque, associé à l'utilisation de meilleures technologies rendent unique l'ambiance salle de bain.



.....	
iX	41
RX	55
PiX	69
UniX	79

LAVABO / BASIN
WASCHTISCH / LAVABO

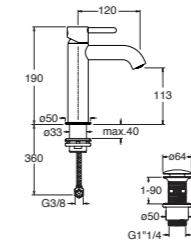

ix 220 28 REGULAR

Miscelatore monocomando
REGULAR per lavabo con
scarico Up&Down da 1"1/4

Waschtisch-Einhandmischer
REGULAR mit Ablaufgarnitur
Up&Down 1"1/4

Basin mixer REGULAR
with 1"1/4 Up&Down
waste

Mitigeur lavabo REGULAR avec
vidage Up&Down 1"1/4

ix 920 Senza scarico * Without waste * Ohne Ablaufgarnitur * Sans vidage

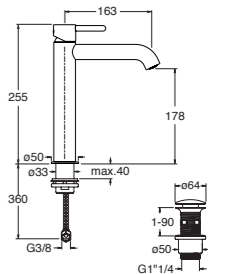

ix 227 28 MEDIUM

Miscelatore monocomando
MEDIUM per lavabo con
scarico Up&Down da 1"1/4

Waschtisch-Einhandmischer
MEDIUM mit Ablaufgarnitur
Up&Down 1"1/4

Basin mixer MEDIUM
with 1"1/4
Up&Down waste

Mitigeur lavabo MEDIUM avec
vidage Up&Down 1"1/4

ix 927 Senza scarico * Without waste * Ohne Ablaufgarnitur * Sans vidage



LAVABO / BASIN
WASCHTISCH / LAVABO

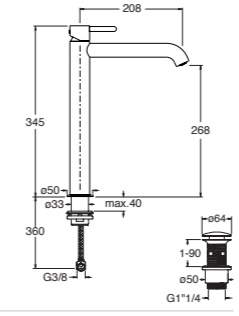

IX 222 28 TALL

Miscelatore monocomando TALL per lavabo con scarico Up&Down da 1"1/4

Basin mixer TALL with 1"1/4 Up&Down waste

Waschtisch-Einhandmischer TALL mit Ablaufgarnitur Up&Down 1"1/4

Mitigeur lavabo TALL avec vidage Up&Down 1"1/4

IX 922 Senza scarico * Without waste * Ohne Ablaufgarnitur * Sans vidage

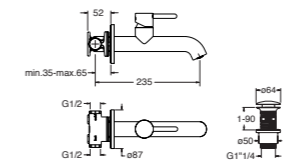

IX 241 28 REGULAR

Set completo per miscelatore monocomando REGULAR lavabo da incasso con scarico Up&Down da 1"1/4

Complete wall mounted basin mixer REGULAR with 1"1/4 Up&Down waste

Unterputz-Waschtisch-Einhandmischer REGULAR Wandmontage inkl. Einbaukörper mit Ablaufgarnitur Up&Down 1"1/4

Mitigeur lavabo REGULAR encastré complet avec vidage Up&Down 1"1/4

IX 941 Senza scarico * Without waste * Ohne Ablaufgarnitur * Sans vidage

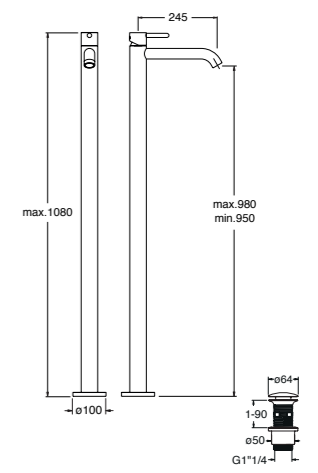
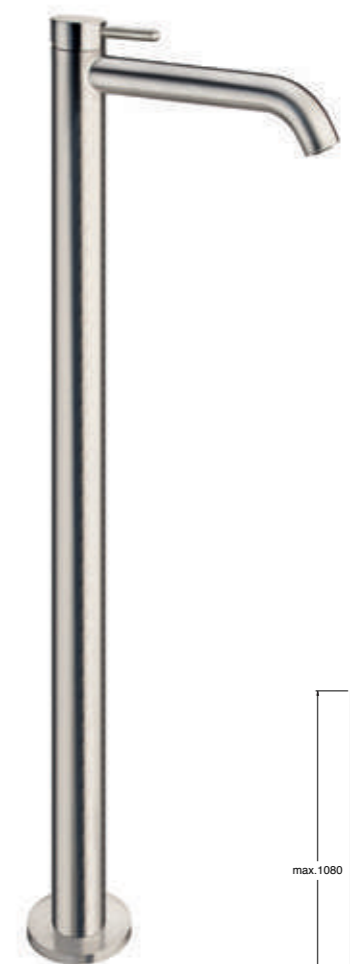

IX 290 28

Set da esterno per miscelatore monocomando lavabo a pavimento CS 290 con scarico Up&Down da 1"1/4

Floor mounted basin mixer external parts for CS 290 with 1"1/4 Up&Down waste

Fertigmontageset Waschtisch-Einhandmischer bodenstehend für Einbaukörper CS 290 mit Ablaufgarnitur Up&Down 1"1/4

Façade externe mitigeur lavabo sur pied pour mécanisme CS 290 avec vidage Up&Down 1"1/4

IX 990 Senza scarico * Without waste * Ohne Ablaufgarnitur * Sans vidage



LAVABO / BASIN
WASCHTISCH / LAVABO

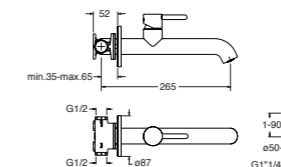

ix 242 28 LARGE

Set completo per miscelatore monocomando LARGE lavabo da incasso con scarico Up&Down da 1"1/4

Unterputz-Waschtisch-Einhandmischer LARGE Wandmontage inkl. Einbaukörper mit Ablaufgarnitur Up&Down 1"1/4

Complete wall mounted basin mixer LARGE with 1"1/4 Up&Down waste

Mitigeur lavabo LARGE encastré complet avec vidage Up&Down 1"1/4

ix 942 Senza scarico * Without waste * Ohne Ablaufgarnitur * Sans vidage

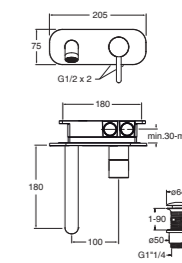

ix 276 28 REGULAR

Set completo per miscelatore monocomando REGULAR lavabo da incasso con scarico Up&Down da 1"1/4

Unterputz-Waschtisch-Einhandmischer REGULAR Wandmontage inkl. Einbaukörper mit Ablaufgarnitur Up&Down 1"1/4

Complete wall mounted basin mixer REGULAR with 1"1/4 Up&Down waste

Mitigeur lavabo REGULAR encastré complet avec vidage Up&Down 1"1/4

ix 976 Senza scarico * Without waste * Ohne Ablaufgarnitur * Sans vidage

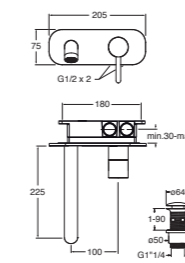

ix 278 28 LARGE

Set completo per miscelatore monocomando LARGE lavabo da incasso con scarico Up&Down da 1"1/4

Unterputz-Waschtisch-Einhandmischer LARGE Wandmontage inkl. Einbaukörper mit Ablaufgarnitur Up&Down 1"1/4

Complete wall mounted basin mixer LARGE with 1"1/4 Up&Down waste

Mitigeur lavabo LARGE encastré complet avec vidage Up&Down 1"1/4

ix 978 Senza scarico * Without waste * Ohne Ablaufgarnitur * Sans vidage

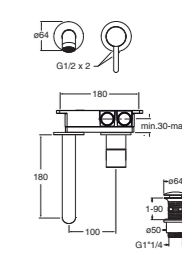

ix 277 28 REGULAR

Set completo per miscelatore monocomando REGULAR lavabo da incasso con scarico Up&Down da 1"1/4

Unterputz-Waschtisch-Einhandmischer REGULAR Wandmontage inkl. Einbaukörper mit Ablaufgarnitur Up&Down 1"1/4

Complete wall mounted basin mixer REGULAR with 1"1/4 Up&Down waste

Mitigeur lavabo REGULAR encastré complet avec vidage Up&Down 1"1/4

ix 977 Senza scarico * Without waste * Ohne Ablaufgarnitur * Sans vidage



LAVABO / BASIN
WASCHTISCH / LAVABO

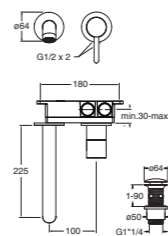

iX 279 28 LARGE

Set completo per miscelatore monocomando LARGE lavabo da incasso con scarico Up&Down da 1"1/4

Unterputz-Waschtisch-Einhandmischer LARGE Wandmontage inkl. Einbaukörper mit Ablaufgarnitur Up&Down 1"1/4

Complete wall mounted basin mixer LARGE with 1"1/4 Up&Down waste

Mitigeur lavabo LARGE encastré complet avec vidage Up&Down 1"1/4

iX 979 Senza scarico * Without waste * Ohne Ablaufgarnitur * Sans vidage

BIDET / BIDET

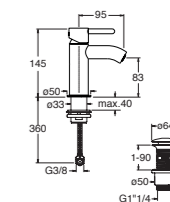

iX 320 28

Miscelatore monocomando per bidet con scarico Up&Down da 1"1/4

Bidet-Einhandmischer mit Ablaufgarnitur Up&Down 1"1/4

Bidet mixer with 1"1/4 Up&Down waste

Mitigeur bidet avec vidage Up&Down 1"1/4

iX 370 Senza scarico * Without waste * Ohne Ablaufgarnitur * Sans vidage

VASCA / BATH
WANNEN / BAIN DOUCHE

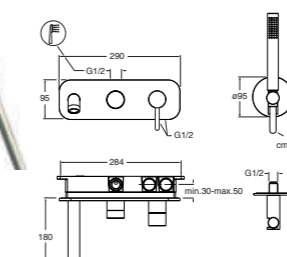

iX 112 28

Set completo per miscelatore monocomando doccia/vasca da incasso con deviatore 2 uscite, flessibile LONG LIFE e doccetta anticalcare

Unterputz Brause/Wannen-Einhandmischer inkl. Einbaukörper mit 2 Wege Umsteller, Brauseschlauch LONG LIFE und Handbrause mit Antikalk-System

Complete concealed bath/shower mixer with 2 outlet diverter, LONG LIFE flexible hose and anti-lime hand shower

Mitigeur douche/bain douche encastré complet avec inverseur 2 sorties, flexible LONG LIFE et douchette anticalcaire

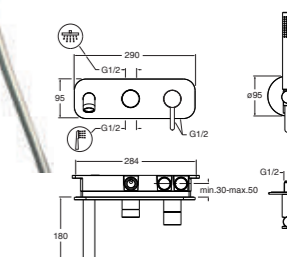

iX 113 28

Set completo per miscelatore monocomando doccia/vasca da incasso con deviatore 3 uscite, flessibile LONG LIFE e doccetta anticalcare

Unterputz Brause/Wannen-Einhandmischer inkl. Einbaukörper mit 3 Wege Umsteller, Brauseschlauch LONG LIFE und Handbrause mit Antikalk-System

Complete concealed bath/shower mixer with 3 outlet diverter, LONG LIFE flexible hose and anti-lime hand shower

Mitigeur douche/bain douche encastré complet avec inverseur 3 sorties, flexible LONG LIFE et douchette anticalcaire

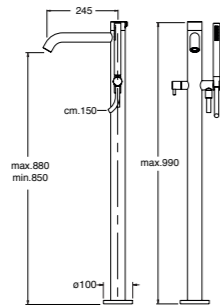

iX 189 28

Set da esterno per miscelatore monocomando vasca a pavimento CS 290 con flessibile LONG LIFE e doccetta anticalcare con miscelazione indipendente

Fertigmontageset Wannen-Einhandmischer bodenstehend für Einbaukörper CS 290 mit Brauseschlauch LONG LIFE und Handbrause mit Antikalk-System und separater Mischung

Floor mounted bath mixer external parts for CS 290 with LONG LIFE flexible hose and anti-lime hand shower with independent mixing

Façade externe mitigeur bain douche sur pied pour mécanisme CS 290 avec flexible LONG LIFE et douchette anticalcaire avec mélange indépendant

iX 618 28

Set completo per miscelatore monocomando doccia/vasca da incasso con deviatore 2 uscite, flessibile LONG LIFE e doccetta anticalcare

Unterputz Brause/Wannen-Einhandmischer inkl. Einbaukörper mit 2 Wege Umsteller, Handbrause mit Antikalk-System und Brauseschlauch LONG LIFE

Complete concealed bath/shower mixer with 2 outlet diverter, LONG LIFE flexible hose and anti-lime hand shower

Mitigeur douche/bain douche encastré complet avec inverseur 2 sorties, douchette anticalcaire et flexible LONG LIFE

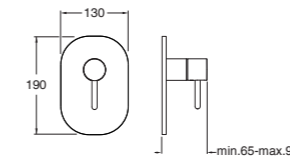
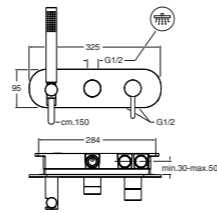

iX 686 28

Set da esterno per miscelatore monocomando doccia CS 535

Fertigmontageset Brause-Einhandmischer für Einbaukörper CS 535

Shower mixer external parts for CS 535

Façade externe pour mitigeur douche 1 sortie pour mécanisme CS 535

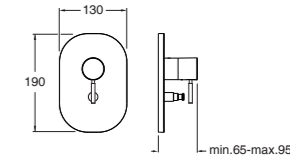

iX 689 28

Set da esterno per miscelatore monocomando doccia/vasca CS 535 con deviatore 2 uscite

Fertigmontageset Wannen/Brause-Einhandmischer für Einbaukörper CS 535 mit 2 Wege Umsteller

Bath/shower mixer external parts for CS 535 with 2 outlet diverter

Façade externe pour mitigeur douche/bain douche 2 sorties pour mécanisme CS 535

WC JET

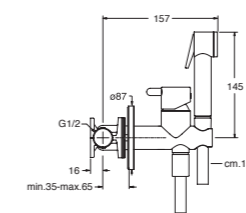

WJ 676 28

Miscelatore monocomando per wc/bidet esterno con flessibile LONG LIFE e doccetta con chiusura

WC/Bidet-Einhandmischer Aufputz mit Brauseschlauch LONG LIFE und Handbrause mit Druckknopf

WC/bidet mixer valve with integrated douche handset holder and LONG LIFE flexible hose

Mitigeur WC/bidet extérieur avec flexible LONG LIFE et douchette à impulsion

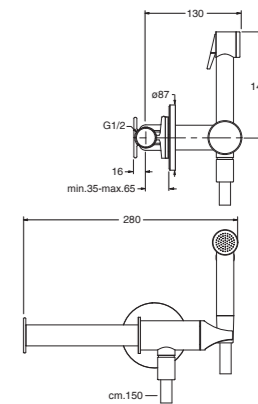

WJ 679 28

Miscelatore monocomando progressivo per wc/bidet esterno con flessibile LONG LIFE, doccetta con chiusura e porta rotolo

WC/Bidet-Einhandmischer mit progressiver Kartusche, Brauseschlauch LONG LIFE, Handbrause mit Druckknopf und Papierrollenhalter

WC/bidet progressive control valve with douche kit with shut off handset, LONG LIFE flexible hose and toilet roll holder

Mitigeur WC/bidet cartouche progressive avec flexible LONG LIFE, douchette à impulsion et porte-rouleau

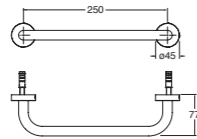

AX 325 28

Portasalvietta interasse 25 cm

Tower rail 25 cm

Handtuchhalter Achsabstand
25 cm

Porte-serviettes entraxe
25 cm

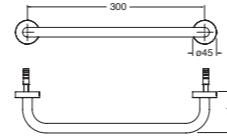

AX 330 28

Portasalvietta interasse 30 cm

Tower rail 30 cm

Handtuchhalter Achsabstand
30 cm

Porte-serviettes entraxe
30 cm

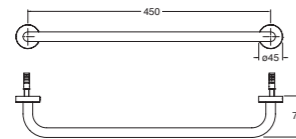

AX 345 28

Portasalvietta interasse 45 cm

Tower rail 45 cm

Handtuchhalter Achsabstand
45 cm

Porte-serviettes entraxe
45 cm

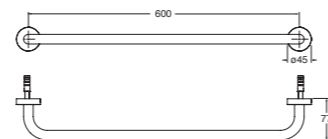

AX 360 28

Portasalvietta interasse 60 cm

Tower rail 60 cm

Handtuchhalter Achsabstand
60 cm

Porte-serviettes entraxe
60 cm



AX 301 28

Appendino

Robe hook

Wand-Kleiderhaken

Porte-peignoir

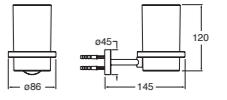

AX 001 28

Porta bicchiere a muro in PETG

Tumbler holder, wall mounted

Wand-Glashalter aus PETG

Porte-verre mural en PETG



AX 004 24

Bicchiere d'appoggio in PETG

Tumbler

Stand-Glashalter aus PETG

Porte-verre à poser en PETG

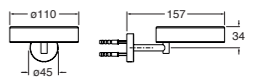

AX 002 28

Porta sapone a muro in PETG

Soap holder, wall mounted

Wand-Seifenhalter aus PETG

Porte-savon mural en PETG



AX 003 24

Porta sapone d'appoggio in PETG Soap dish

Stand-Seifenhalter aus PETG

Porte-savon à poser en PETG

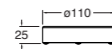

AX 040 28

Maniglione 25 cm

Haltegriff 25 cm

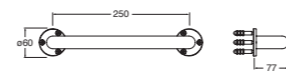

Grab-bar 25 cm.

Barre murale 25 cm



AX 050 28

Porta scopino a pavimento

Stand-Toilettenbürsten-Garnitur

Toilet brush holder

Porte-balai à poser

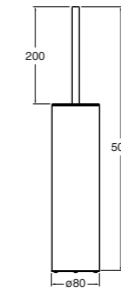

AX 390 28

Porta rotolo

Papierrollenhalter

Toilet roll holder

Porte-rouleau

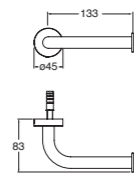

AX 030 28

Porta rotolo di scorta

Reserverollenhalter

Toilet roll holder reserve

Porte-rouleau de rchange

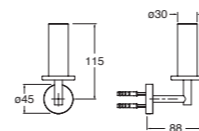

LAVABO / BASIN
WASCHTISCH / LAVABO

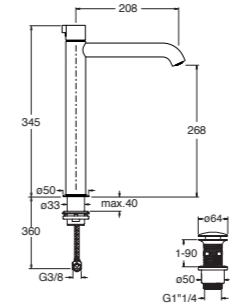

RX 212 28 TALL

Miscelatore monocomando progressivo TALL per lavabo con scarico Up&Down da 1"1/4

Progressive basin mixer TALL with 1"1/4 Up&Down waste

Waschtisch-Einhandmischer TALL mit progressiver Kartusche und Ablaufgarnitur Up&Down 1"1/4

Mitigeur lavabo TALL cartouche progressive avec vidage Up&Down 1"1/4

RX 912 Senza scarico * Without waste * Ohne Ablaufgarnitur * Sans vidage

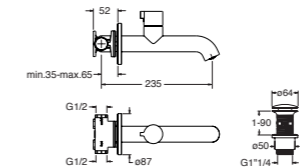

RX 231 28 REGULAR

Set completo per miscelatore monocomando progressivo REGULAR lavabo da incasso con scarico Up&Down da 1"1/4

Complete wall mounted progressive basin mixer REGULAR with 1"1/4 Up&Down waste

Unterputz-Waschtisch-Einhandmischer REGULAR Wandmontage inkl. Einbaukörper mit progressiver Kartusche und Ablaufgarnitur Up&Down 1"1/4

Mitigeur lavabo REGULAR encastré complet avec cartouche progressive et vidage Up&Down 1"1/4

RX 931 Senza scarico * Without waste * Ohne Ablaufgarnitur * Sans vidage

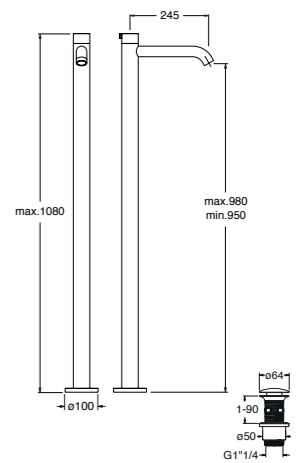
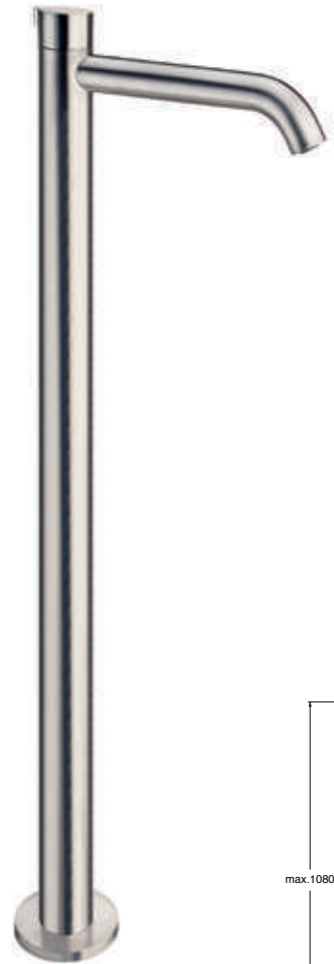

RX 280 28

Set da esterno per miscelatore monocomando progressivo lavabo a pavimento CS 290 con scarico Up&Down da 1"1/4

Floor mounted progressive basin mixer external parts for CS 290 with 1"1/4 Up&Down waste

Fertigmontageset Waschtisch-Einhandmischer mit progressiver Kartusche bodenstehend für Einbaukörper CS 290 mit Ablaufgarnitur Up&Down 1"1/4

Façade externe mitigeur lavabo sur pied avec cartouche progressive pour mécanisme CS 290, avec vidage Up&Down 1"1/4

RX 980 Senza scarico * Without waste * Ohne Ablaufgarnitur * Sans vidage



LAVABO / BASIN
WASCHTISCH / LAVABO

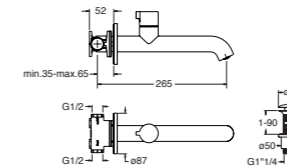

RX 232 28 LARGE

Set completo per miscelatore monocomando progressivo LARGE lavabo da incasso con scarico Up&Down da 1"1/4

Unterputz-Waschtisch-Einhandmischer LARGE Wandmontage inkl. Einbaukörper mit progressiver Kartusche und Ablaufgarnitur Up&Down 1"1/4

RX 932 Senza scarico · Without waste · Ohne Ablaufgarnitur · Sans vidage

Complete wall mounted progressive basin mixer LARGE with 1"1/4 Up&Down waste

Mitigeur lavabo LARGE encastré complet avec cartouche progressive et vidage Up&Down 1"1/4

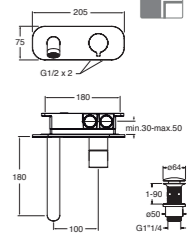
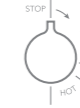

RX 266 28 REGULAR

Set completo per miscelatore monocomando progressivo REGULAR lavabo da incasso con scarico Up&Down da 1"1/4

Unterputz-Waschtisch-Einhandmischer REGULAR Wandmontage inkl. Einbaukörper mit progressiver Kartusche und Ablaufgarnitur Up&Down 1"1/4

RX 966 Senza scarico · Without waste · Ohne Ablaufgarnitur · Sans vidage

Complete wall mounted progressive basin mixer REGULAR with 1"1/4 Up&Down waste

Mitigeur lavabo REGULAR encastré complet avec cartouche progressive et vidage Up&Down 1"1/4

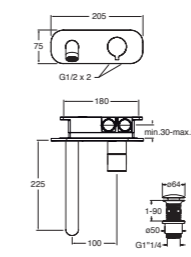

RX 268 28 LARGE

Set completo per miscelatore monocomando progressivo LARGE lavabo da incasso con scarico Up&Down da 1"1/4

Unterputz-Waschtisch-Einhandmischer LARGE Wandmontage inkl. Einbaukörper mit progressiver Kartusche und Ablaufgarnitur Up&Down 1"1/4

RX 968 Senza scarico · Without waste · Ohne Ablaufgarnitur · Sans vidage

Complete wall mounted progressive basin mixer LARGE with 1"1/4 Up&Down waste

Mitigeur lavabo LARGE encastré complet avec cartouche progressive et vidage Up&Down 1"1/4

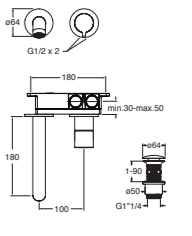

RX 267 28 REGULAR

Set completo per miscelatore monocomando progressivo REGULAR lavabo da incasso con scarico Up&Down da 1"1/4

Unterputz-Waschtisch-Einhandmischer REGULAR Wandmontage inkl. Einbaukörper mit progressiver Kartusche und Ablaufgarnitur Up&Down 1"1/4

RX 967 Senza scarico · Without waste · Ohne Ablaufgarnitur · Sans vidage

Complete wall mounted progressive basin mixer REGULAR with 1"1/4 Up&Down waste

Mitigeur lavabo REGULAR encastré complet avec cartouche progressive et vidage Up&Down 1"1/4



RX 310

LAVABO / BASIN
WASCHTISCH / LAVABO



RX 269 28 LARGE

Set completo per miscelatore monocomando progressivo LARGE lavabo da incasso con scarico Up&Down da 1"1/4

Unterputz-Waschtisch-Einhandmischer LARGE Wandmontage inkl. Einbaukörper mit progressiver Kartusche und Ablaufgarnitur Up&Down 1"1/4

Complete wall mounted progressive basin mixer LARGE with 1"1/4 Up&Down waste

Mitigeur lavabo LARGE encastré complet avec cartouche progressive et vidage Up&Down 1"1/4

RX 969 Senza scarico · Without waste · Ohne Ablaufgarnitur · Sans vidage

BIDET / BIDET

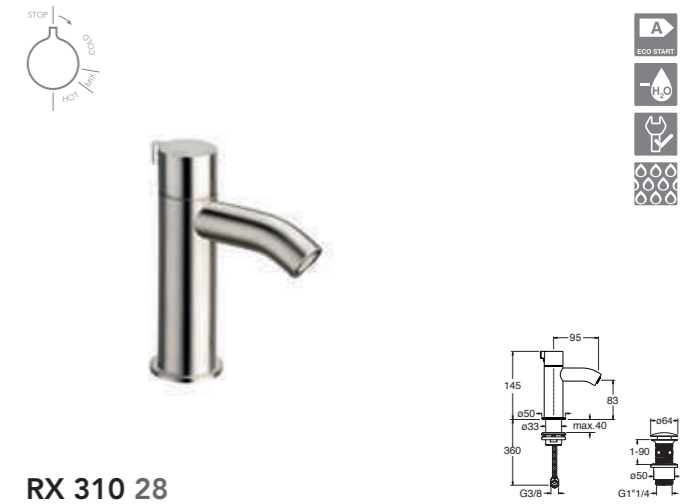

RX 310 28

Miscelatore monocomando progressivo per bidet con scarico Up&Down da 1"1/4

Bidet-Einhandmischer mit progressiver Kartusche und Ablaufgarnitur Up&Down 1"1/4

Progressive bidet mixer with 1"1/4 Up&Down waste

Mitigeur bidet cartouche progressive avec vidage Up&Down 1"1/4

RX 360 Senza scarico · Without waste · Ohne Ablaufgarnitur · Sans vidage

VASCA / BATH
WANNEN / BAIN DOUCHE



RX 102 28

Set completo per miscelatore monocomando progressivo doccia/vasca da incasso con deviatore 2 uscite, flessibile LONG LIFE e doccetta anticalcare

Unterputz Brause/Wannen-Einhandmischer inkl. Einbaukörper mit progressiver Kartusche, 2 Wege Umsteller, Brauseschlauch LONG LIFE und Handbrause mit Antikalk-System

Complete concealed progressive bath/shower mixer with 2 outlet diverter, LONG LIFE flexible hose and anti-lime hand shower

Mitigeur douche/bain douche encastré complet avec cartouche progressive, inverseur 2 sorties, flexible LONG LIFE et douchette anticalcaire

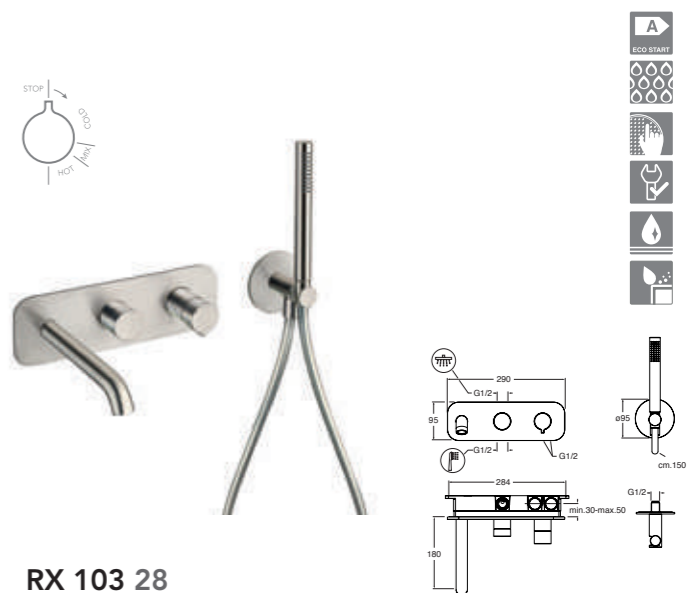

RX 103 28

Set completo per miscelatore monocomando progressivo doccia/vasca da incasso con deviatore 3 uscite, flessibile LONG LIFE e doccetta anticalcare

Unterputz Brause/Wannen-Einhandmischer inkl. Einbaukörper mit progressiver Kartusche, 3 Wege Umsteller, Brauseschlauch LONG LIFE und Handbrause mit Antikalk-System

Complete concealed progressive bath/shower mixer with 3 outlet diverter, LONG LIFE flexible hose and anti-lime hand shower

Mitigeur douche/bain douche encastré complet avec cartouche progressive, inverseur 3 sorties, flexible LONG LIFE et douchette anticalcaire

VASCA / BATH
WANNEN / BAIN DOUCHE

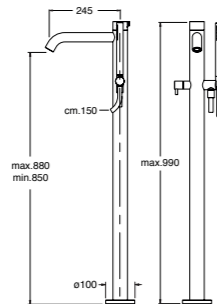

RX 179 28

Set da esterno per miscelatore monocomando progressivo vasca a pavimento CS 290 con flessibile LONG LIFE e doccetta anticalcare con miscelazione indipendente

Fertigmontageset Wannens-Einhandmischer mit progressiver Kartusche bodenstehend für Einbaukörper CS 290 mit Brauseschlauch LONG LIFE und Handbrause mit Antikalk-System und separater Mischung

Floor mounted progressive bath mixer external parts for CS 290 with LONG LIFE flexible hose and anti-lime hand shower with independent mixing

Façade externe mitigeur bain douche sur pied avec cartouche progressive pour mécanisme CS 290, avec flexible LONG LIFE et douchette anticalcaire avec mélange indépendant

DOCCIA / SHOWER
BRAUSE / DOUCHE

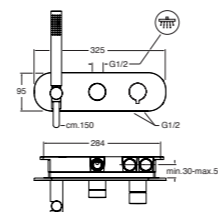

RX 608 28

Set completo per miscelatore monocomando progressivo doccia/ vasca da incasso con deviatore 2 uscite, doccetta anticalcare e flessibile LONG LIFE

Unterputz Brause/Wannens-Einhandmischer inkl. Einbaukörper mit progressiver Kartusche, 2 Wege Umsteller, Handbrause mit Antikalk-System und Brauseschlauch LONG LIFE

Complete concealed progressive bath/shower mixer with 2 outlet diverter, LONG LIFE flexible hose and anti-lime hand shower

Mitigeur douche/bain douche encastré complet avec cartouche progressive, inverseur 2 sorties, douchette anticalcaire et flexible LONG LIFE

DOCCIA / SHOWER
BRAUSE / DOUCHE

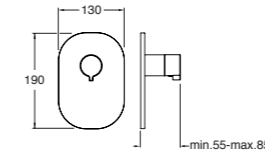

RX 666 28

Set da esterno per miscelatore monocomando progressivo doccia CS 535

Fertigmontageset Brause-Einhandmischer mit progressiver Kartusche für Einbaukörper CS 535

Progressive shower mixer external parts for CS 535

Façade externe pour mitigeur douche cartouche progressive 1 sortie pour mécanisme CS 535

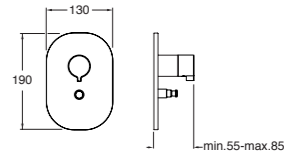

RX 669 28

Set da esterno per miscelatore monocomando progressivo doccia/vasca CS 535 con deviatore 2 uscite

Fertigmontageset Wannens/Brause-Einhandmischer mit progressiver Kartusche für Einbaukörper CS 535 mit 2 Wege Umsteller

Progressive Bath/shower mixer external parts for CS 535 with 2 outlet diverter

Façade externe pour mitigeur douche/bain douche cartouche progressive 2 sorties pour mécanisme CS 535

WC JET

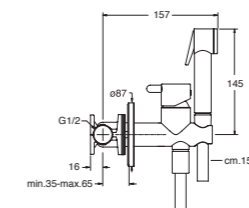

WJ 676 28

Miscelatore monocomando per wc/bidet esterno con flessibile LONG LIFE e doccetta con chiusura

WC/Bidet-Einhandmischer Aufputz mit Brauseschlauch LONG LIFE und Handbrause mit Druckknopf

WC/bidet mixer valve with integrated douche handset holder and LONG LIFE flexible hose

Mitigeur WC/bidet extérieur avec flexible LONG LIFE et douchette à impulsion

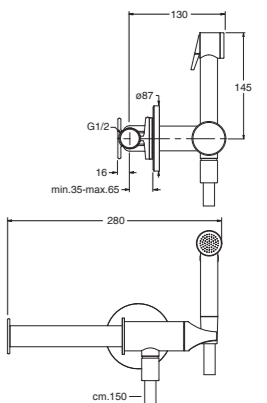

WJ 679 28

Miscelatore monocomando progressivo per wc/bidet esterno con flessibile LONG LIFE, doccetta con chiusura e porta rotolo

WC/Bidet-Einhandmischer mit progressiver Kartusche, Brauseschlauch LONG LIFE, Handbrause mit Druckknopf und Papierrollenhalter

WC/bidet progressive control valve with douche kit with shut off handset, LONG LIFE flexible hose and toiler roll holder

Mitigeur WC/bidet cartouche progressive avec flexible LONG LIFE, douchette à impulsion et porte-rouleau

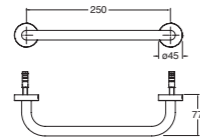

AX 325 28

Portasalvietta interasse 25 cm

Tower rail 25 cm

Handtuchhalter Achsabstand
25 cm

Porte-serviettes entraxe
25 cm

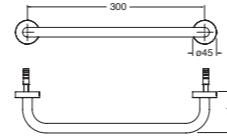

AX 330 28

Portasalvietta interasse 30 cm

Tower rail 30 cm

Handtuchhalter Achsabstand
30 cm

Porte-serviettes entraxe
30 cm

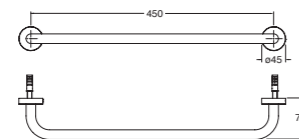

AX 345 28

Portasalvietta interasse 45 cm

Tower rail 45 cm

Handtuchhalter Achsabstand
45 cm

Porte-serviettes entraxe
45 cm

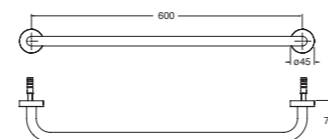

AX 360 28

Portasalvietta interasse 60 cm

Tower rail 60 cm

Handtuchhalter Achsabstand
60 cm

Porte-serviettes entraxe
60 cm



AX 301 28

Appendino

Robe hook

Wand-Kleiderhaken

Porte-peignoir

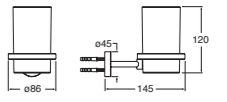

AX 001 28

Porta bicchiere a muro in PETG

Tumbler holder, wall mounted

Wand-Glashalter aus PETG

Porte-verre mural en PETG

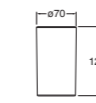

AX 004 24

Bicchiere d'appoggio in PETG

Tumbler

Stand-Glashalter aus PETG

Porte-verre à poser en PETG

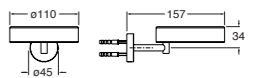

AX 002 28

Porta sapone a muro in PETG

Soap holder, wall mounted

Wand-Seifenhalter aus PETG

Porte-savon mural en PETG



AX 003 24

Porta sapone d'appoggio in PETG Soap dish

Stand-Seifenhalter aus PETG

Porte-savon à poser en PETG

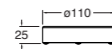

AX 040 28

Maniglione 25 cm

Haltegriff 25 cm

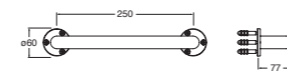

Grab-bar 25 cm.

Barre murale 25 cm



AX 050 28

Porta scopino a pavimento Toilet brush holder

Stand-Toilettenbürsten-Garnitur

Porte-balai à poser

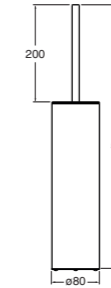

AX 390 28

Porta rotolo Toilet roll holder

Papierrollenhalter

Porte-rouleau

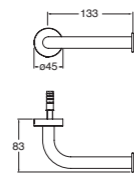

AX 030 28

Porta rotolo di scorta Toilet roll holder reserve

Reserverollenhalter

Porte-rouleau de rchange

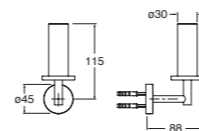

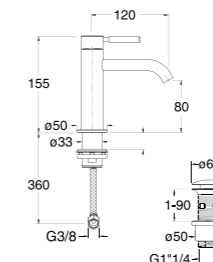

PX 220 28 REGULAR

Miscelatore monocomando
REGULAR per lavabo con
scarico Up&Down da 1"1/4

Basin mixer
REGULAR with 1"1/4
Up&Down waste

Waschtisch-Einhandmischer
REGULAR mit Ablaufgarnitur
Up&Down 1"1/4

Mitigeur lavabo REGULAR avec
vidage Up&Down 1"1/4

PX 920 Senza scarico * Without waste * Ohne Ablaufgarnitur * Sans vidage

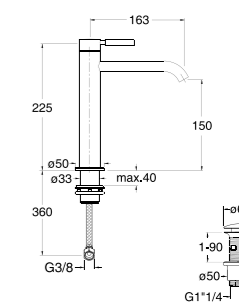

PX 227 28 MEDIUM

Miscelatore monocomando
MEDIUM per lavabo con
scarico Up&Down da 1"1/4

Basin mixer
MEDIUM with 1"1/4
Up&Down waste

Waschtisch-Einhandmischer
MEDIUM mit Ablaufgarnitur
Up&Down 1"1/4

Mitigeur lavabo MEDIUM avec
vidage Up&Down 1"1/4

PX 927 Senza scarico * Without waste * Ohne Ablaufgarnitur * Sans vidage

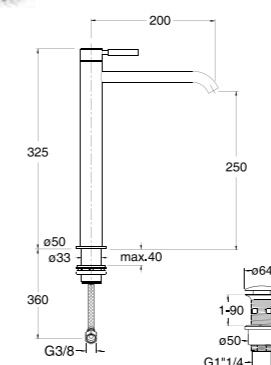

PX 222 28 TALL

Miscelatore monocomando
TALL per lavabo con
scarico Up&Down da 1"1/4

Basin mixer
TALL with 1"1/4
Up&Down waste

Waschtisch-Einhandmischer
TALL mit Ablaufgarnitur
Up&Down 1"1/4

Mitigeur lavabo TALL avec vidage
Up&Down 1"1/4

PX 922 Senza scarico * Without waste * Ohne Ablaufgarnitur * Sans vidage

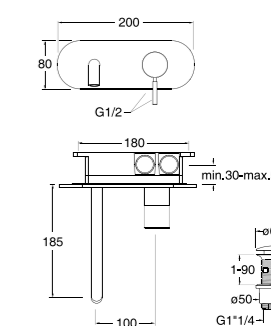

PX 276 28 REGULAR

Set completo per miscelatore
monocomando lavabo REGULAR
da incasso destro con scarico
Up&Down da 1"1/4

Complete wall mounted basin
mixer REGULAR with 1"1/4
Up&Down waste - right side

Unterputz-Waschtisch-
Einhandmischer REGULAR
(rechts) Wandmontage inkl.
Einbaukörper mit Ablaufgarnitur
Up&Down 1"1/4

Mitigeur droite lavabo REGULAR
encastré complet avec vidage
Up&Down 1"1/4

PX 976 Senza scarico * Without waste * Ohne Ablaufgarnitur * Sans vidage



LAVABO / BASIN
WASCHTISCH / LAVABO

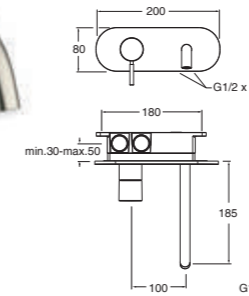

PX 277 28 REGULAR

Set completo per miscelatore monocomando lavabo REGULAR da incasso sinistro con scarico Up&Down da 1"1/4

Unterputz-Waschtisch-Einhandmischer REGULAR (links) Wandmontage inkl. Einbaukörper mit Ablaufgarnitur Up&Down 1"1/4

Complete wall mounted basin mixer REGULAR with 1"1/4Up&Down waste left side

Mitigeur gauche lavabo REGULAR encastré complet avec vidage Up&Down 1"1/4

PX 977 Senza scarico · Without waste · Ohne Ablaufgarnitur · Sans vidage

BIDET / BIDET

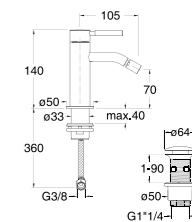

PX 320 28

Miscelatore monocomando per bidet con scarico Up&Down da 1"1/4

Bidet-Einhandmischer mit Ablaufgarnitur Up&Down 1"1/4

Bidet mixer with 1"1/4 Up&Down waste

Mitigeur bidet avec vidage Up&Down 1"1/4

PX 370 Senza scarico · Without waste · Ohne Ablaufgarnitur · Sans vidage



VASCA / BATH
WANNEN / BAIN DOUCHE



PX 108 28

Set completo per miscelatore monocomando doccia/vasca da incasso con deviatore 2 uscite, flessibile LONG LIFE e doccetta anticalcare

Unterputz Brause/Wannen-Einhandmischer inkl. Einbaukörper mit 2 Wege Umsteller, Brauseschlauch LONG LIFE und Handbrause mit Antikalk-System

Complete concealed bath/shower mixer with 2 outlets diverter, LONG LIFE flexible hose and anti-lime hand shower

Mitigeur douche/bain douche encastré complet avec inverseur 2 sorties, flexible LONG LIFE et douchette anticalcaire

PX 110 28

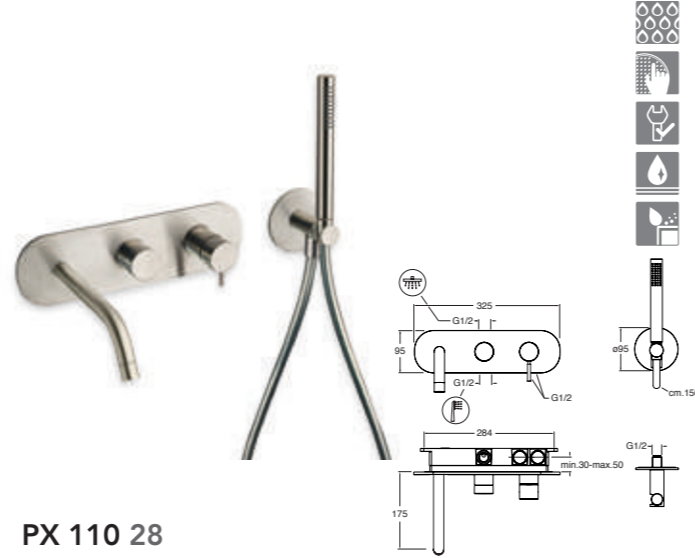

Set completo per miscelatore monocomando doccia/vasca da incasso con deviatore 3 uscite, flessibile LONG LIFE e doccetta anticalcare

Unterputz Brause/Wannen-Einhandmischer inkl. Einbaukörper mit 3 Wege Umsteller, Brauseschlauch LONG LIFE und Handbrause mit Antikalk-System

Complete concealed bath/shower mixer with 3 outlets diverter, LONG LIFE flexible hose and anti-lime hand shower

Mitigeur douche/bain douche encastré complet avec inverseur 3 sorties, flexible LONG LIFE et douchette anticalcaire

DOCCIA / SHOWER
BRAUSE / DOUCHE



PX 686 28

Set da esterno per miscelatore monocomando doccia CS 535

Fertigmontageset Brause-Einhandmischer für Einbaukörper CS 535

Shower mixer external parts for CS 535

Façade externe pour mitigeur douche 1 sortie pour mécanisme CS 535

PX 689 28



Set da esterno per miscelatore monocomando doccia/vasca CS 535 con deviatore 2 uscite

Fertigmontageset Wannen/Brause-Einhandmischer für Einbaukörper CS 535 mit 2 Wege Umsteller

Bath/shower mixer external parts for CS 535 with 2 outlet diverter

Façade externe pour mitigeur douche/bain douche 2 sorties pour mécanisme CS 535

DOCCIA / SHOWER
BRAUSE / DOUCHE

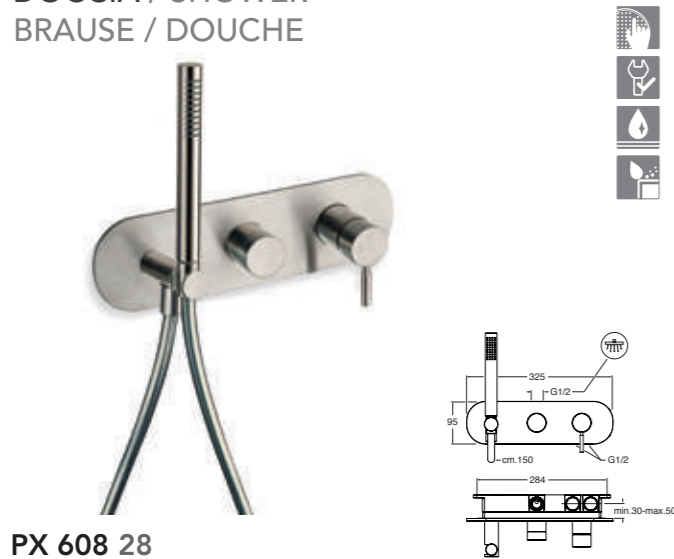

PX 608 28

Set completo per miscelatore monocomando doccia/vasca da incasso con deviatore 2 uscite, doccetta anticalcare e flessibile LONG LIFE

Unterputz Brause/Wannen-Einhandmischer inkl. Einbaukörper mit 2 Wege Umsteller, Handbrause mit Antikalk-System und Brauseschlauch LONG LIFE

Complete concealed bath/shower mixer with 2 outlet diverter, anti-lime hand shower and LONG LIFE flexible hose

Mitigeur douche/bain douche encastré complet avec inverseur 2 sorties, douchette anticalcaire et flexible LONG LIFE

PX 610 28

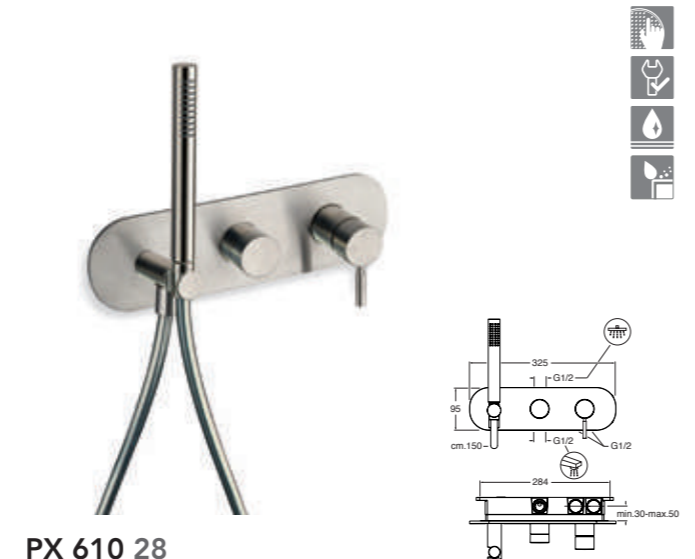

Set completo per miscelatore monocomando doccia/vasca da incasso con deviatore 3 uscite, doccetta anticalcare e flessibile LONG LIFE

Unterputz Brause/Wannen-Einhandmischer inkl. Einbaukörper mit 3 Wege Umsteller, Handbrause mit Antikalk-System und Brauseschlauch LONG LIFE

Complete concealed bath/shower mixer with 3 outlet diverter, anti-lime hand shower and LONG LIFE flexible hose

Mitigeur douche/bain douche encastré complet avec inverseur 3 sorties, douchette anticalcaire et flexible LONG LIFE

WC JET



WJ 676 28

Miscelatore monocomando per wc/bidet esterno con flessibile LONG LIFE e doccetta con chiusura

WC/Bidet-Einhandmischer Aufputz mit Brauseschlauch LONG LIFE und Handbrause mit Druckknopf

WC/bidet mixer valve with integrated douche handset holder and LONG LIFE flexible hose

Mitigeur WC/bidet extérieur avec flexible LONG LIFE et douchette à impulsion

WJ 679 28

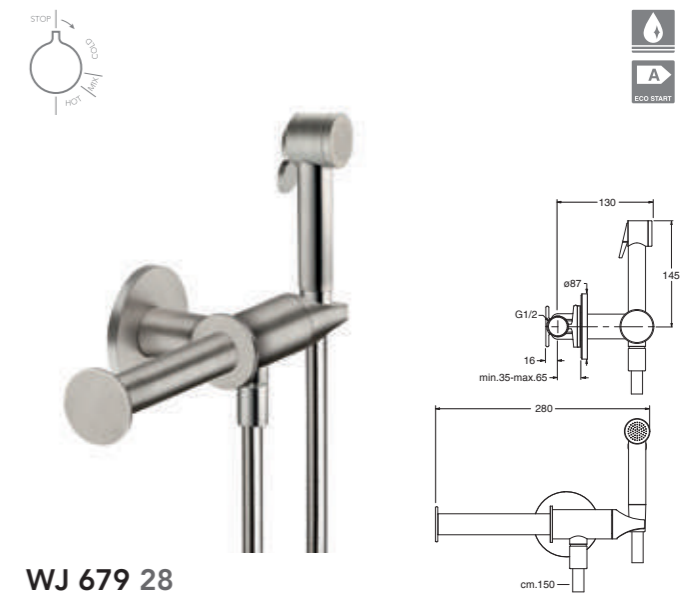

Miscelatore monocomando progressivo per wc/bidet esterno con flessibile LONG LIFE, doccetta con chiusura e porta rotolo

WC/Bidet-Einhandmischer mit progressiver Kartusche, Brauseschlauch LONG LIFE, Handbrause mit Druckknopf und Papierrollenhalter

WC/bidet progressive control valve with douche kit with shut off handset, LONG LIFE flexible hose and toilet roll holder

Mitigeur WC/bidet cartouche progressive avec flexible LONG LIFE, douchette à impulsion et porte-rouleau

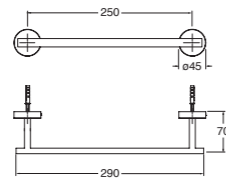

AX 225 28

Portasalvietta interasse 25 cm

Tower rail 25 cm

Handtuchhalter Achsabstand
25 cm

Porte-serviettes entraxe
25 cm

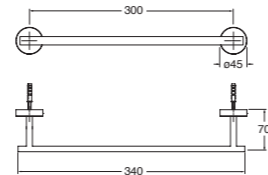

AX 230 28

Portasalvietta interasse 30 cm

Tower rail 30 cm

Handtuchhalter Achsabstand
30 cm

Porte-serviettes entraxe
30 cm

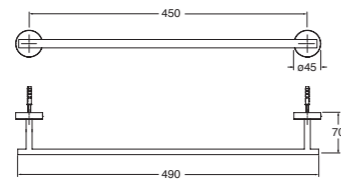

AX 245 28

Portasalvietta interasse 45 cm

Tower rail 45 cm

Handtuchhalter Achsabstand
45 cm

Porte-serviettes entraxe
45 cm

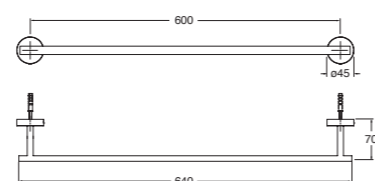

AX 260 28

Portasalvietta interasse 60 cm

Tower rail 60 cm

Handtuchhalter Achsabstand
60 cm

Porte-serviettes entraxe
60 cm

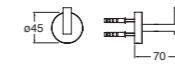

AX 201 28

Appendino

Robe hook

Wand-Kleiderhaken

Porte-peignoir

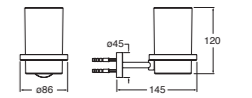

AX 001 28

Porta bicchiere a muro in PETG

Tumbler holder, wall mounted

Wand-Glashalter aus PETG

Porte-verre mural en PETG

iX 241 28 REGULAR



AX 004 24

Bicchiere d'appoggio in PETG

Tumbler

Stand-Glashalter aus PETG

Porte-verre à poser en PETG

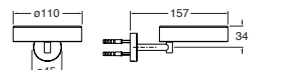

AX 002 28

Porta sapone a muro in PETG

Soap holder, wall mounted

Wand-Seifenhalter aus PETG

Porte-savon mural en PETG



AX 003 24

Porta sapone d'appoggio in PETG Soap dish

Stand-Seifenhalter aus PETG

Porte-savon à poser en PETG

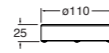

AX 040 28

Maniglione 25 cm

Haltegriff 25 cm

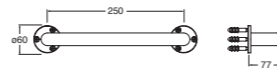

Grab-bar 25 cm.

Barre murale 25 cm



AX 050 28

Porta scopino a pavimento Toilet brush holder

Stand-Toilettenbürsten-Garnitur

Porte-balai à poser

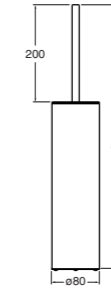

AX 390 28

Porta rotolo Toilet roll holder

Papierrollenhalter

Porte-rouleau

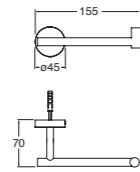

AX 030 28

Porta rotolo di scorta Toilet roll holder reserve

Reserverollenhalter

Porte-rouleau de rchange

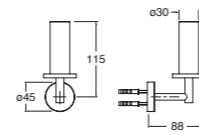

LAVABO / BASIN
WASCHTISCH / LAVABO

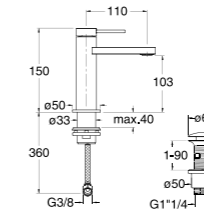

UX 220 28 REGULAR

Miscelatore monocomando
REGULAR per lavabo
con scarico Up&Down da 1"1/4

Basin mixer
REGULAR with 1"1/4
Up&Down waste

Waschtisch-Einhandmischer
REGULAR mit Ablaufgarnitur
Up&Down 1"1/4

Mitigeur lavabo REGULAR avec
vidage Up&Down 1"1/4

UX 920 Senza scarico * Without waste * Ohne Ablaufgarnitur * Sans vidage

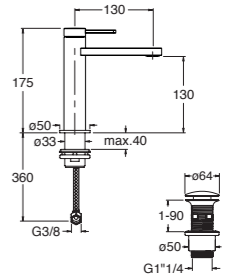

UX 223 28 LARGE

Miscelatore monocomando
LARGE per lavabo con
scarico Up&Down da 1"1/4

Basin mixer
LARGE with 1"1/4
Up&Down waste

Waschtisch-Einhandmischer
LARGE mit Ablaufgarnitur
Up&Down 1"1/4

Mitigeur lavabo LARGE avec
vidage Up&Down 1"1/4

UX 923 Senza scarico * Without waste * Ohne Ablaufgarnitur * Sans vidage

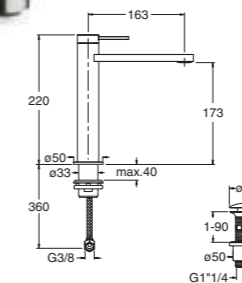

UX 227 28 MEDIUM

Miscelatore monocomando
MEDIUM per lavabo con
scarico Up&Down da 1"1/4

Basin mixer
MEDIUM with 1"1/4
Up&Down waste

Waschtisch-Einhandmischer
MEDIUM mit Ablaufgarnitur
Up&Down 1"1/4

Mitigeur lavabo MEDIUM avec
vidage Up&Down 1"1/4

UX 927 Senza scarico * Without waste * Ohne Ablaufgarnitur * Sans vidage

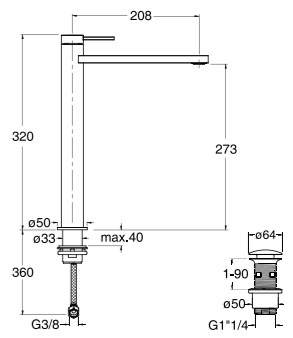

UX 222 28 TALL

Miscelatore monocomando
TALL per lavabo con
scarico Up&Down da 1"1/4

Basin mixer
TALL with 1"1/4
Up&Down waste

Waschtisch-Einhandmischer
TALL mit Ablaufgarnitur
Up&Down 1"1/4

Mitigeur lavabo TALL avec
vidage Up&Down 1"1/4

UX 922 Senza scarico * Without waste * Ohne Ablaufgarnitur * Sans vidage



LAVABO / BASIN
WASCHTISCH / LAVABO

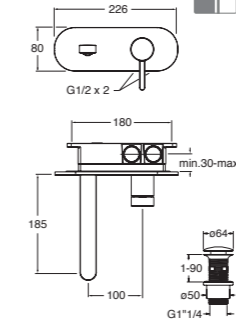

UX 276 28 REGULAR

Set completo per miscelatore monocomando lavabo REGULAR da incasso destro con scarico Up&Down da 1"1/4

Unterputz-Waschtisch-Einhandmischer REGULAR (rechts) Wandmontage inkl. Einbaukörper mit Ablaufgarnitur Up&Down 1"1/4

Complete wall mounted basin mixer REGULAR with 1"1/4Up&Down waste - right side

Mitigeur droite lavabo REGULAR encastré complet avec vidage Up&Down 1"1/4

UX 976 Senza scarico * Without waste * Ohne Ablaufgarnitur * Sans vidage

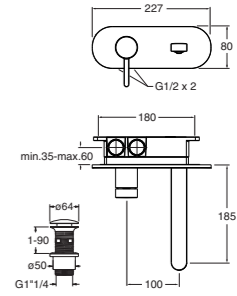

UX 277 28 REGULAR

Set completo per miscelatore monocomando lavabo REGULAR da incasso sinistro con scarico Up&Down da 1"1/4

Unterputz-Waschtisch-Einhandmischer REGULAR (links) Wandmontage inkl. Einbaukörper mit Ablaufgarnitur Up&Down 1"1/4

Set completo per miscelatore monocomando lavabo REGULAR da incasso sinistro con scarico Up&Down da 1"1/4

Mitigeur gauche lavabo REGULAR encastré complet avec vidage Up&Down 1"1/4

UX 977 Senza scarico * Without waste * Ohne Ablaufgarnitur * Sans vidage

BIDET / BIDET

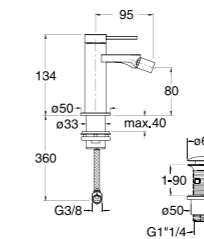

UX 320 28

Miscelatore monocomando per bidet con scarico Up&Down da 1"1/4

Bidet-Einhandmischer mit Ablaufgarnitur Up&Down 1"1/4

Bidet mixer with 1"1/4 Up&Down waste

Mitigeur bidet avec vidage Up&Down 1"1/4

UX 370 Senza scarico * Without waste * Ohne Ablaufgarnitur * Sans vidage

VASCA / BATH
WANNEN / BAIN DOUCHE

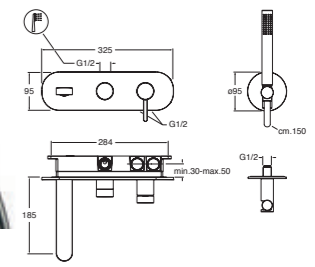

UX 108 28

Set completo per miscelatore monocomando doccia/vasca da incasso con deviatore 2 uscite, flessibile LONG LIFE e doccetta anticalcare

Unterputz Brause/Wannen-Einhandmischer inkl. Einbaukörper mit 2 Wege Umsteller, Brauseschlauch LONG LIFE und Handbrause mit Antikalk-System

Complete concealed bath/shower mixer with 2 outlets diverter, LONG LIFE flexible hose and anti-lime hand shower

Mitigeur douche/bain douche encastré complet avec inverseur 2 sorties, flexible LONG LIFE et douchette anticalcaire

VASCA / BATH
WANNEN / BAIN DOUCHE

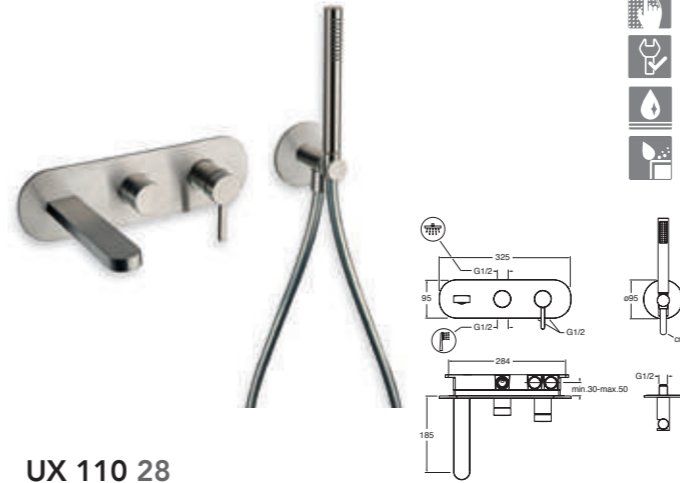

UX 110 28

Set completo per miscelatore monocomando doccia/vasca da incasso con deviatore 3 uscite, flessibile LONG LIFE e doccetta anticalcare

Unterputz Brause/Wannen-Einhandmischer inkl. Einbaukörper mit 3 Wege Umsteller, Brauseschlauch LONG LIFE und Handbrause mit Antikalk-System

Complete concealed bath/shower mixer with 3 outlets diverter, LONG LIFE flexible hose and anti-lime hand shower

Mitigeur douche/bain douche encastré complet avec inverseur 3 sorties, flexible LONG LIFE et douchette anticalcaire

DOCCIA / SHOWER
BRAISE / DOUCHE

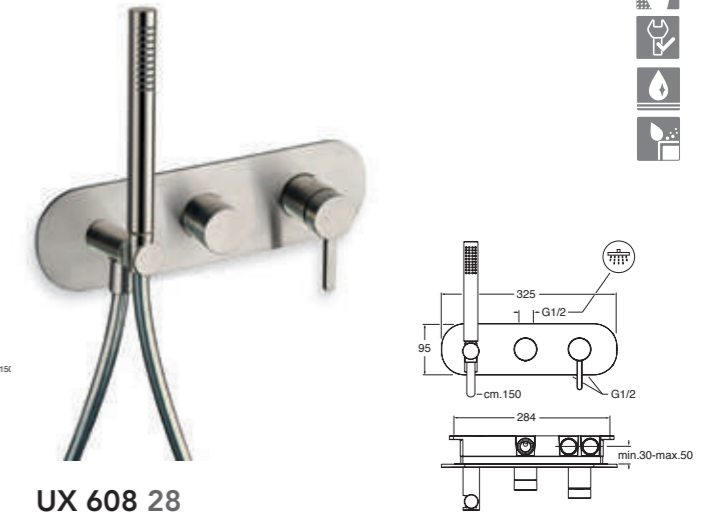

UX 608 28

Set completo per miscelatore monocomando doccia/vasca da incasso con deviatore 2 uscite, doccetta anticalcare e flessibile LONG LIFE

Unterputz Brause/Wannen-Einhandmischer inkl. Einbaukörper mit 2 Wege Umsteller, Handbrause mit Antikalk-System und Brauseschlauch LONG LIFE

Complete concealed bath/shower mixer with 2 outlet diverter, anti-lime hand shower and LONG LIFE flexible hose

Mitigeur douche/bain douche encastré complet avec inverseur 2 sorties, douchette anticalcaire et flexible LONG LIFE

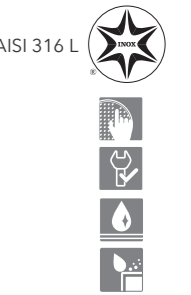

UX 108

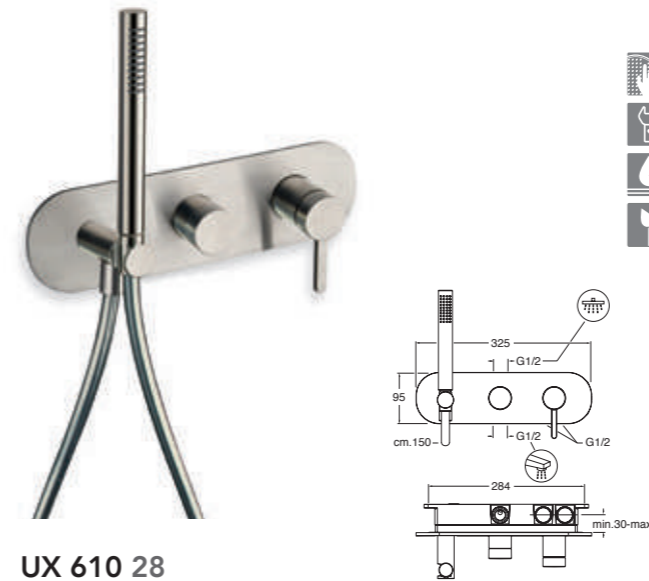

UX 610 28

Set completo per miscelatore monocomando doccia/vasca da incasso con deviatore 3 uscite, doccetta anticalcare e flessibile LONG LIFE

Unterputz Brause/Wannen-Einhandmischer inkl. Einbaukörper mit 3 Wege Umsteller, Handbrause mit Antikalk-System und Brauseschlauch LONG LIFE

Complete concealed bath/shower mixer with 3 outlet diverter, anti-lime hand shower and LONG LIFE flexible hose

Mitigeur douche/bain douche encastré complet avec inverseur 3 sorties, douchette anticalcaire et flexible LONG LIFE

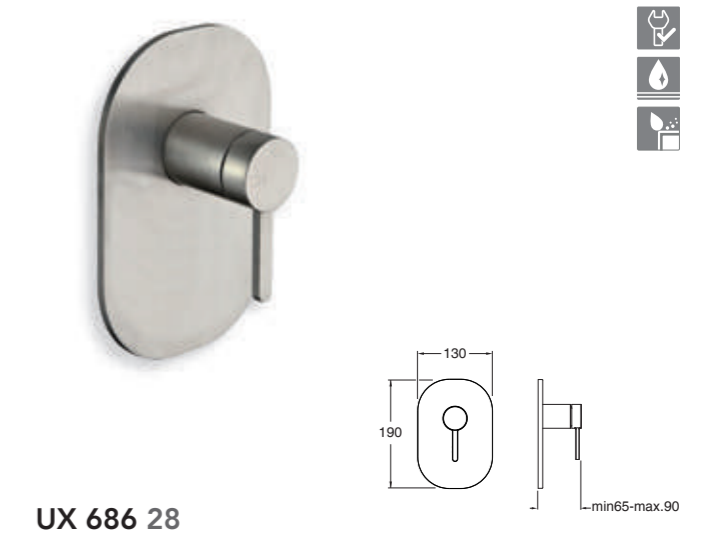

UX 686 28

Set da esterno per miscelatore monocomando doccia CS 535

Fertigmontageset Brause-Einhandmischer für Einbaukörper CS 535

Shower mixer external parts for CS 535

Façade externe pour mitigeur douche 1 sortie pour mécanisme CS 535

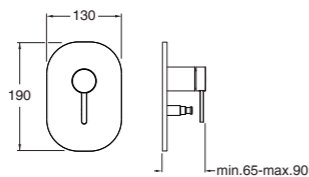

UX 689 28

Set da esterno per miscelatore monocomando doccia/vasca CS 535 con deviatore 2 uscite

Bath/shower mixer external parts for CS 535 with 2 outlet diverter

Fertigmontageset Wannen/ Brause-Einhandmischer für Einbaukörper CS 535 mit 2 Wege Umsteller

Façade externe pour mitigeur douche/bain douche 2 sorties pour mécanisme CS 535

WC JET

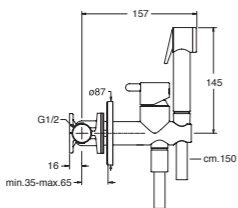

WJ 676 28

Miscelatore monocomando per wc/bidet esterno con flessibile LONG LIFE e doccetta con chiusura

WC/bidet mixer valve with integrated douche handset holder and LONG LIFE flexible hose

WC/Bidet-Einhandmischer Aufputz mit Brauseschlauch LONG LIFE und Handbrause mit Druckknopf

Mitigeur WC/bidet extérieur avec flexible LONG LIFE et douchette à impulsion

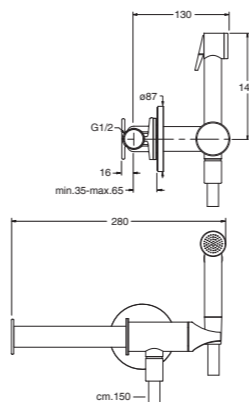

WJ 679 28

Miscelatore monocomando progressivo per wc/bidet esterno con flessibile LONG LIFE, doccetta con chiusura e porta rotolo

WC/bidet progressive control valve with douche kit with shut off handset, LONG LIFE flexible hose and toiler roll holder

WC/Bidet-Einhandmischer mit progressiver Kartusche, Brauseschlauch LONG LIFE, Handbrause mit Druckknopf und Papierrollenhalter

Mitigeur WC/bidet cartouche progressive avec flexible LONG LIFE, douchette à impulsion et porte-rouleau

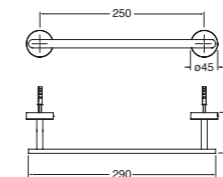

AX 125 28

Portasalvietta interasse 25 cm

Tower rail 25 cm

Handtuchhalter Achsabstand 25 cm

Porte-serviettes entraxe 25 cm

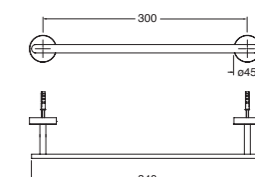

AX 130 28

Portasalvietta interasse 30 cm

Tower rail 30 cm

Handtuchhalter Achsabstand 30 cm

Porte-serviettes entraxe 30 cm

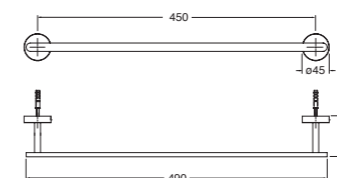

AX 145 28

Portasalvietta interasse 45 cm

Tower rail 45 cm

Handtuchhalter Achsabstand 45 cm

Porte-serviettes entraxe 45 cm

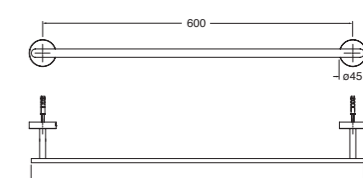

AX 160 28

Portasalvietta interasse 60 cm

Tower rail 60 cm

Handtuchhalter Achsabstand 60 cm

Porte-serviettes entraxe 60 cm



ACCESSORI / ACCESSORIES
ACCESSOIRES - ACCESSOIRES



AX 101 28

Appendino

Wand-Kleiderhaken

Robe hook

Porte-peignoir



AX 001 28

Porta bicchiere a muro in PETG

Wand-Glashalter aus PETG

Tumbler holder, wall mounted

Porte-verre mural en PETG

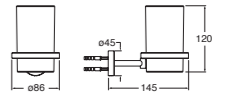

AX 004 24

Bicchiere d'appoggio in PETG

Stand-Glashalter aus PETG

Tumbler

Porte-verre à poser en PETG



AX 002 28

Porta sapone a muro in PETG

Wand-Seifenhalter aus PETG

Soap holder, wall mounted

Porte-savon mural en PETG

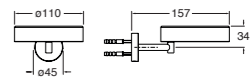

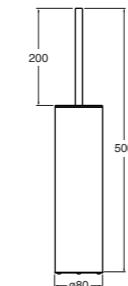
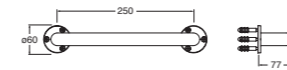
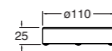

AX 003 24

Porta sapone d'appoggio in PETG Soap dish

Stand-Seifenhalter aus PETG

Porte-savon à poser en PETG

AX 040 28

Maniglione 25 cm

Haltegriff 25 cm

Grab-bar 25 cm.

Barre murale 25 cm

AX 050 28

Porta scopino a pavimento

Stand-Toilettenbürsten-Garnitur

Toilet brush holder

Porte-balai à poser

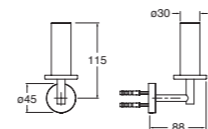
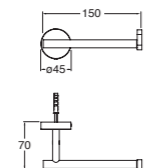

AX 190 28

Porta rotolo Toilet roll holder

Papierrollenhalter

Porte-rouleau

AX 030 28

Porta rotolo di scorta Toilet roll holder reserve

Reserverollenhalter

Porte-rouleau de rchange