





Agrémentez votre baignoire avec une de nos vasques à poser qui vous correspond. Choisissez entre un style moderne ou plus traditionnel. Certains modèles ont été conçus pour être associés à des baignoires spécifiques, alors que d'autres conviennent naturellement à toutes les formes et tous les styles.

Ergänzen Sie Ihr Bad mit einem unserer freistehenden Waschbecken. Wählen Sie zwischen modernen und traditionellen Stilrichtungen. Einige Modelle wurden passend zu bestimmten Wannenserien entwickelt, andere lassen sich wiederum wunderbar mit vielen verschiedenen Designs und Formen kombinieren.

Completa la tua vasca con uno dei nostri corrispondenti lavabi freestanding. Con gli stili moderni e tradizionali tra cui scegliere, sono stati progettati una serie di modelli per soddisfare certe vasche, mentre altri complementano naturalmente molteplici forme e stili.

Vul uw vrijstaand bad aan met onze opzetwastafels. Kies uit moderne of traditionele stijlen, een aantal modellen zijn specifiek ontworpen om ter aanvulling op specifieke baden, terwijl anderen perfect bij verschillende vormen passen.

 AN Gris Anthracite. Anthrazit. Antracite. Antraciet.	 BK Noir Brillant. Schwarz Lack. Nero Lucido. Zwart Glans.	 GR Gris Clair. Hellgrau. Grigio Chiaro. Licht Grijs.
 SG Gris Pierre. Steingrau. Grigio Pietra. Steen Grijs.	 MW Blanc Mat. Mattweiß. Bianco Opaco. Wit Mat.	 MB Noir Mat. Mattschwarz. Nero Opaco. Zwart Mat.
 SW QUARRYCAST® Blanc QUARRYCAST® Weiß. QUARRYCAST® Bianco. QUARRYCAST® Wit.		

 rich in Volcanic Limestone™

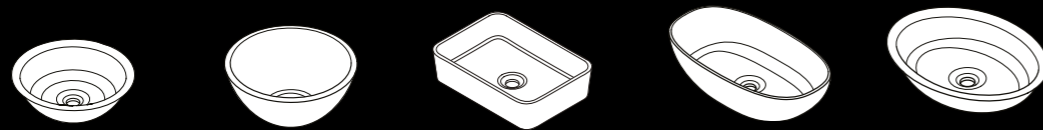

Drayton 40	Maru 42	Edge 45	Barcelona 48	Radford 51
400 x 400	423 x 423	450 x 325	480 x 301	510 x 395
Page 160	Page 168	Page 162	Page 152	Page 172

Internal overflow

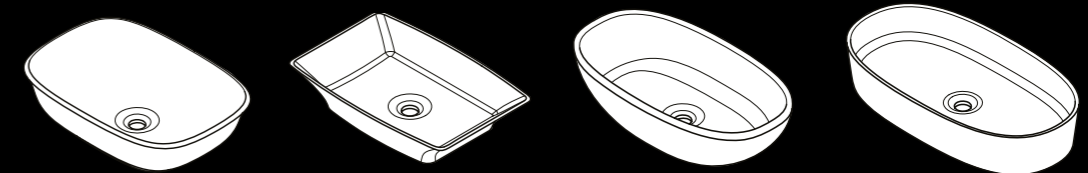

Amiata 60	Ravello 60	Barcelona 64	ios 80
600 x 413	612 x 411	635 x 346	810 x 432
Page 150	Page 174	Page 156	Page 166

Internal overflow



ios 54	Barcelona 55	Amalfi 55	Cabrits 55	Napoli 57
540 x 362	546 x 329	550 x 340	550 x 340	570 x 345
Page 164	Page 154	Page 148	Page 158	Page 170

Internal overflow



Internal overflow / Trop-plein intégré / Integrierter Überlauf / Troppopieno interno / Geïntegreerde overloop.



○ VB-AML-55-NO  ▼ VB-AML55-xx-NO 

  Massachusetts Code
cUPC listing by IAPMO

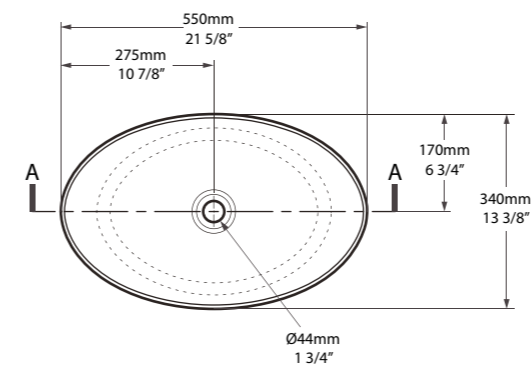

Top View

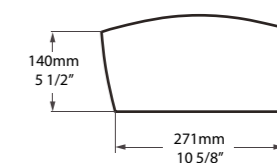

Side View

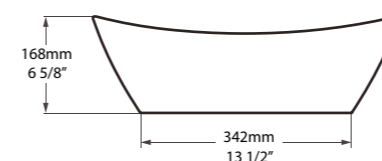

Front View

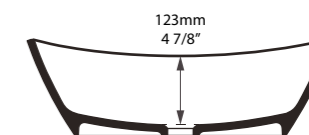

Section AA

La vasque Amalfi 55 est caractérisée par des lignes épurées et des courbes élégantes. Elle a été conçue pour accompagner la baignoire Amalfi mais fonctionne aussi bien avec n'importe laquelle de nos baignoires modernes. Disponible en sept couleurs.

Das Amalfi 55 Becken besticht durch klare Linien und elegante Rundungen. Es wurde als Ergänzung zur Amalfi Wanne gestaltet, harmonisiert aber ebenso mit unseren anderen modernen Wannern. Erhältlich in 7 Farboberflächen.

L'Amalfi 55 è caratterizzato da linee pulite e curve eleganti. È stato progettato per completare la vasca Amalfi, ma è abbinabile con qualsiasi nostra vasca moderna. Disponibile in sette finiture di colore.

De Amalfi 55 wordt gekenmerkt door strakke lijnen en elegante rondingen. Het is ontworpen ter aanvulling op het Amalfi bad, maar past eigenlijk goed bij al onze moderne baden. Verkrijgbaar in zeven kleuren afwerkingen.

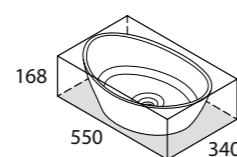

○ VB-AML-55-NO
▼ VB-AML55-xx-NO
6Kg



  rich in Volcanic Limestone

 AN BK GR MB MW SG



Amiata 60

○ VB-AMT-60-NO  ⚡ VB-AMT60-xx-NO 

CE  Massachusetts Code
cUPC listing by IAPMO

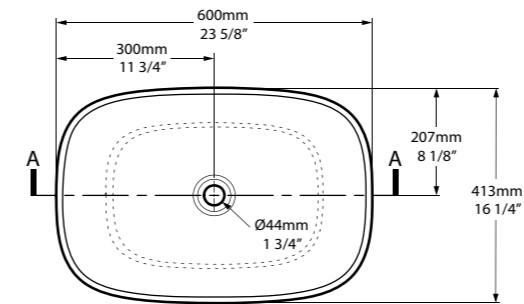

Top View

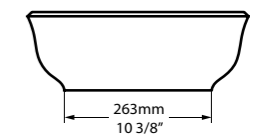

Side View

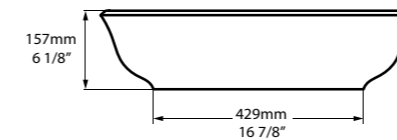

Front View

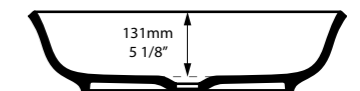

Section AA

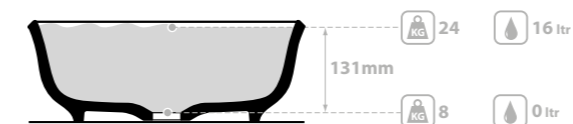

reddot award 2015
winner

Amiata 60 est une vasque à poser généreuse conçue pour accompagner la baignoire en îlot Amiata. Conçue par Meneghello Paoletti Associati. Disponible en sept couleurs.

Das Amiata 60 Becken ist ein großzügig bemessenes Aufsatzwaschbecken und wurde als Ergänzung zur freistehenden Amiata Wanne gestaltet. Designed von Meneghello Paoletti Associati. Erhältlich in 7 Farboberflächen.

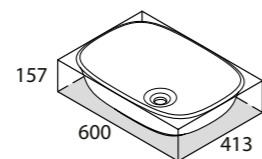

○ VB-AMT-60-NO
⚡ VB-AMT60-xx-NO
8Kg

L'Amiata 60 è un lavabo di dimensioni generose, progettato per integrare la vasca freestanding Amiata. Progettato da Meneghello Paoletti Associati. Disponibile in sette finiture di colore.

De Amiata 60 is een ruime opzetwastafel passend bij het Amiata vrijstaande bad. Ontworpen door Meneghello Paoletti Associati. Verkrijgbaar in zeven kleuren afwerkingen.

SW  rich in Volcanic Limestone

 **AN** **BK** **GR** **MB** **MW** **SG**



Barcelona 48

○ VB-BAR-48-NO  ⚡ VB-BAR48-xx-NO 

  Massachusetts Code
cUPC listing by IAPMO

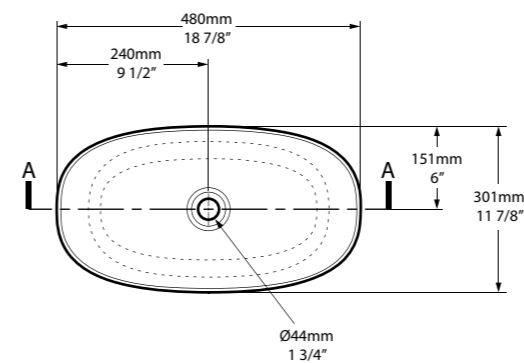

Top View

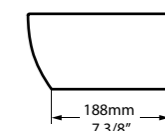

Side View

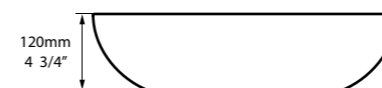

Front View

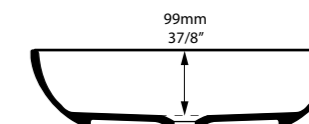

Section AA

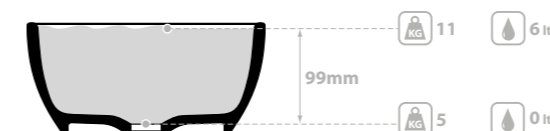

Barcelona 48 est une vasque élégante en forme de galet. Elle s'associe parfaitement aux baignoires Barcelona, et est idéale dans les toilettes ou en aménagement duo. Disponible en sept couleurs. Voir également les modèles Barcelona 55 et Barcelona 64.

Das Barcelona 48 Becken ist glatt und kieselsteinförmig gestaltet; die perfekte Ergänzung zu den Barcelona Wannen. Ideal für Gäste-WCs oder als Doppelwaschtisch. Erhältlich in 7 Farboberflächen. Beachten Sie ebenfalls Barcelona 55 und 64.

Barcelona 48 è un lavabo elegante a forma di sasso; complementa perfettamente le vasche Barcelona. Ideale per piccoli bagni o in coppia nelle impostazioni 'Lui' e 'Lei'. Disponibile in sette finiture di colore. Vedi inoltre Barcelona 55 e Barcelona 64.

De Barcelona 48 is een slanke kiezel-vormige bekken; de perfecte aanvulling op de Barcelona baden. Ideaal voor de kleine badkamer of in duo opzet 'voor hem en haar'. Verkrijgbaar in zeven kleuren afwerkingen. Zie ook Barcelona 55 en Barcelona 64.

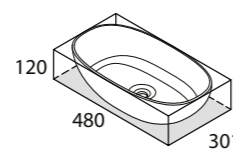

○ VB-BAR-48-NO
⚡ VB-BAR48-xx-NO
5Kg

  rich in Volcanic Limestone™

 AN BK GR MB MW SG

Barcelona 55

CE  Massachusetts Code: Pending
cUPC listing by IAPMO: Pending

○ VB-BAR-55-IO  ▼ VB-BAR55-xx-IO 

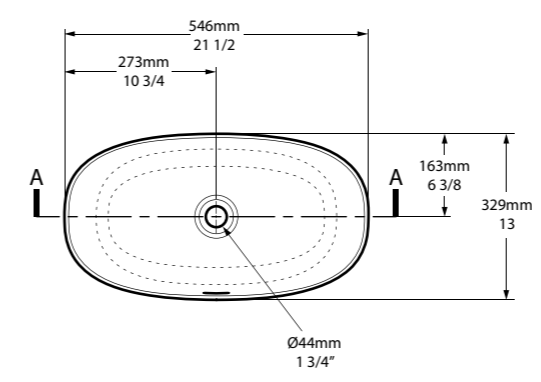

Top View

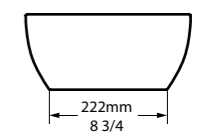

Side View

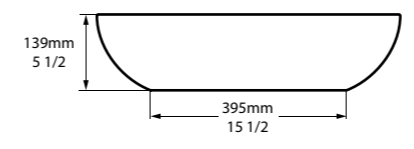

Front View

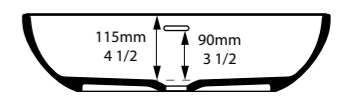

Section AA

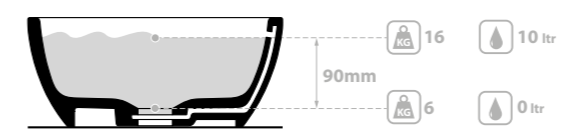

La vasque Barcelona 55 complète idéalement aux baignoires Barcelona, et est idéale dans les toilettes ou en aménagement duo. Dispose d'un trop-plein intégré. Disponible en sept couleurs. Voir également les modèles Barcelona 48 et Barcelona 64.

De Barcelona 55 is de perfecte aanvulling op de Barcelona baden. Voorzien van geïntegreerde overloop. Verkrijgbaar in zeven kleuren afwerkingen.

Das Becken Barcelona 55 ist die perfekte Ergänzung zu den Barcelona Wannen. Ideal für Gäste-WCs oder als Doppelwaschtisch. Mit eingebautem Überlauf. Erhältlich in 7 Farboberflächen. Beachten Sie ebenfalls Barcelona 48 und 64.

Barcelona 55 complementa perfettamente le vasche Barcelona. Caratterizzato da un troppopieno interno. Disponibile in sette diversi colori. Vedi inoltre Barcelona 48 e Barcelona 64.

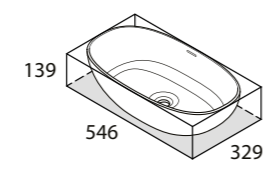

○ VB-BAR-55-IO
▼ VB-BAR55-xx-IO
6Kg

SW  rich in Volcanic Limestone™





○ VB-BAR-64-NO  ▮ VB-BAR64-xx-NO 

  Massachusetts Code
cUPC listing by IAPMO

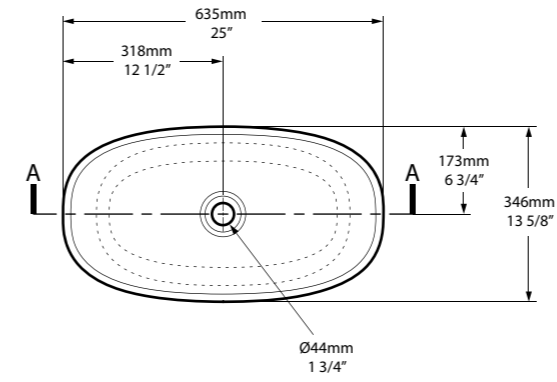

Top View

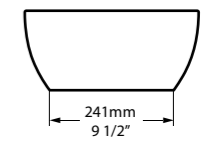

Side View

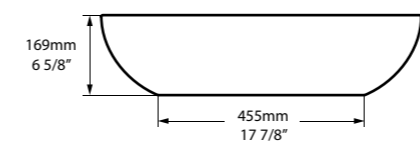

Front View

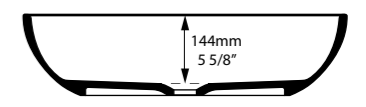

Section AA

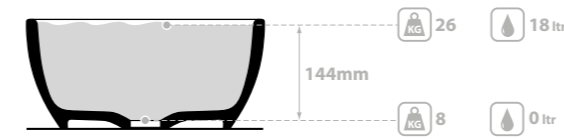

Barcelona 64 est une vasque aux dimensions généreuses, en forme de galet. Elle s'associe parfaitement aux baignoires Barcelona. Disponible en sept couleurs. Voir également les modèles Barcelona 48 et Barcelona 55.

Barcelona 64 ist ein großes, kieselsteinförmiges Becken; die perfekte Ergänzung zu den Barcelona Wannen. Ideal für Gäste-WCs oder als Doppelwaschtisch. Erhältlich in 7 Farboberflächen. Beachten Sie ebenfalls Barcelona 48 und 55.

Barcelona 64: Un ampio lavabo senza bordo e' stato progettato da abbinare perfettamente alle vasche Barcelona. Disponibile in sette diversi colori. Vedi inoltre Barcelona 48 e Barcelona 55.

De Barcelona 64 is een ruim kiezel-vormige wasbak; perfect passend bij de Barcelona baden. Verkrijgbaar in zeven kleuren afwerkingen. Zie ook Barcelona 48 en Barcelona 55.

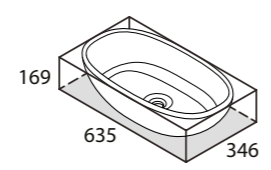

○ VB-BAR-64-NO
▮ VB-BAR64-xx-NO
8Kg

  rich in Volcanic Limestone

      



Cabrits 55

○ VB-CAB-55-NO  ▼ VB-CAB55-xx-NO 

CE  Massachusetts Code
cUPC listing by IAPMO

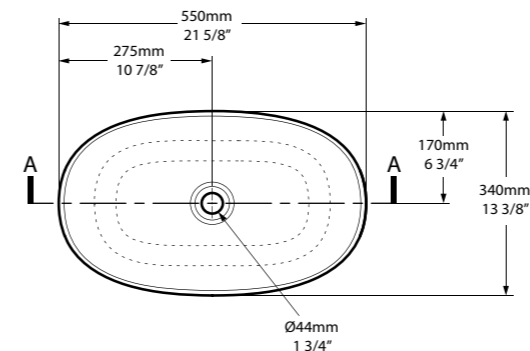

Top View

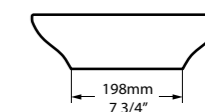

Side View

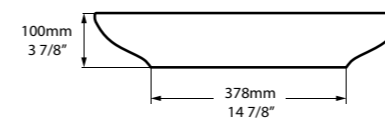

Front View

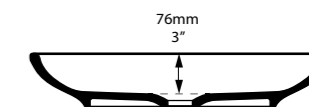

Section AA

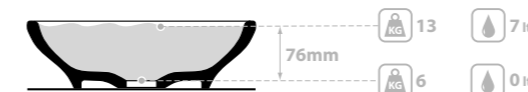

La vasque Cabrits 55 est une vasque sophistiquée, basse, et caractérisée par des courbes singulières. Conçue pour accompagner la baignoire Cabrits. Disponible en sept couleurs.

De lage Cabrits 55 wasbak heeft complexe rondingen, ontworpen ter aanvulling op het bad Cabrits. Verkrijgbaar in zeven kleuren afwerkingen.

Das Cabrits 55 Waschbecken ist ein tief geschnittenes, elegantes Waschbecken mit komplexen Kurven, und damit die ideale Ergänzung zur Cabrits Wanne. Erhältlich in 7 Farboberflächen.

Il lavabo Cabrits 55 è un sofisticato lavabo dall forma gradevole e snella, progettato per integrare la vasca Cabrits. Disponibile in sette finiture di colore.

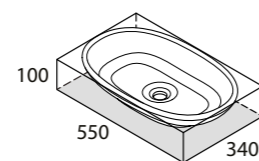

○ VB-CAB-55-NO
▼ VB-CAB55-xx-NO
6Kg

SW  rich in Volcanic Limestone®





Newport Beach, California, USA



Photography by: Ryan Garvin

La Drayton 40 est une vasque à poser de style traditionnel avec un rebord tout en finesse. Conçue pour accompagner la baignoire en filot Drayton. Disponible en sept couleurs.

Drayton 40 ist ein traditionelles Aufsatzwaschbecken mit fein verziertem Rand. Designed als Ergänzung zur freistehenden Drayton Wanne. Erhältlich in 7 Farboberflächen.

Il lavandino Drayton 40 tradizionale con sottile dettgalio sul bordo che può essere montato ad appoggio o incasso. Disponibile in sette finiture di colore.

De Drayton 40 is een traditionele wasbak met subtiële rand detaillering. Passend bij het Drayton bad. Verkrijgbaar in zeven kleuren afwerkingen.

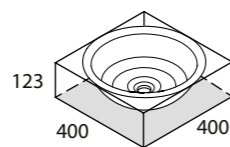

○ VB-DRA-40-NO
 ▣ VB-DRA40-xx-NO
 4Kg

○ VB-DRA-40-NO  ▣ VB-DRA40-xx-NO 

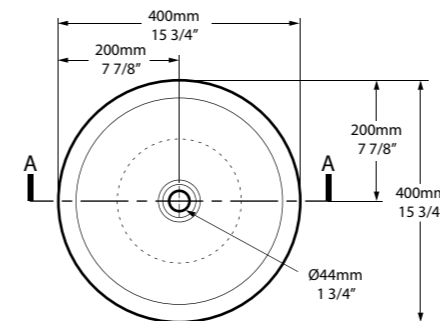

Top View

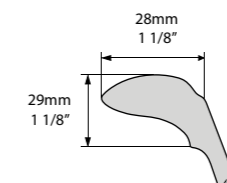

Rim Detail

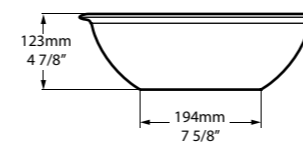

Front View

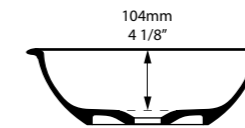

Section AA

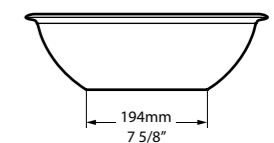

Side View

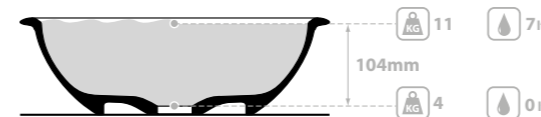

○ VB-EDG-45-NO  ▼ VB-EDG45-xx-NO 

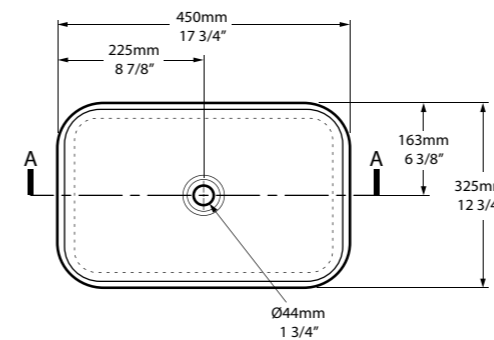

Top View

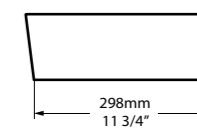

Side View

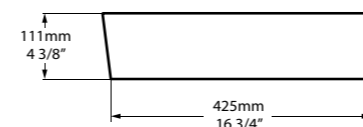

Front View

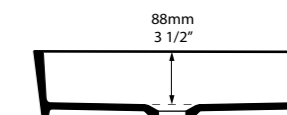

Section AA

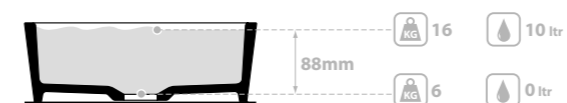

Compacte, la vasque Edge 45 se distingue par ses formes cubiques. Parfaite pour accompagner la baignoire Edge. Disponible en sept couleurs.

De Edge 45 is een compacte kubistische gestylde wasbak. Perfect te combineren met het Edge bad. Verkrijgbaar in zeven kleuren afwerkingen.

Edge 45 ist ein kompakt bemessenes Waschbecken im kubischen Stil. Perfekt in Kombination mit der Edge Wanne. Erhältlich in 7 Farboberflächen.

Il lavabo Edge 45 e' compatto e caratterizzato da uno stile cubico. Perfetto per completare la vasca Edge. Disponibile in sette finiture di colore.

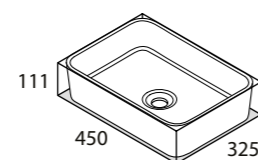

○ VB-EDG-45-NO
▼ VB-EDG45-xx-NO
6Kg





○ VB-IOS-54-NO  ⚡ VB-IOS54-xx-NO 

CE  Massachusetts Code
cUPC listing by IAPMO

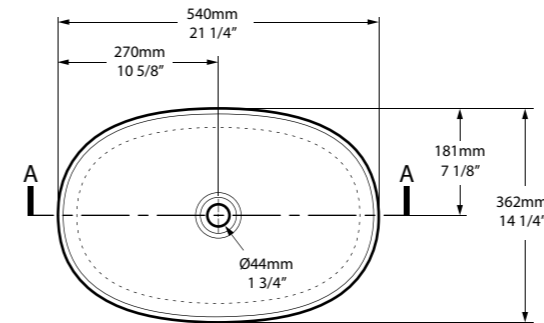

Top View

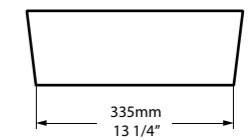

Side View

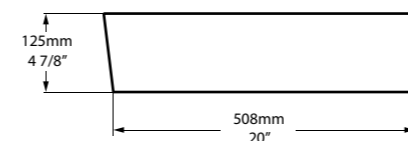

Front View

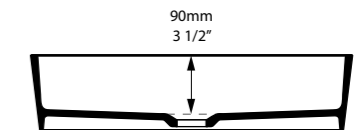

Section AA

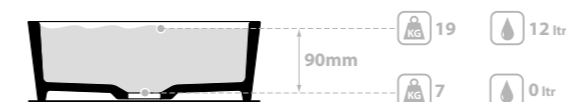

La vasque à poser ios 54 sans rebord a été conçue pour accompagner la baignoire ios. Disponible également dans des dimensions plus généreuses, consulter ios 80. Disponible en sept couleurs.

De ios 54 is een randloze opzetwastafel ontworpen ter aanvulling op het ios bad. Ook verkrijgbaar in een groter formaatzie ios 80. Verkrijgbaar in zeven kleuren afwerkingen.

ios 54 ist ein randloses Aufsatzwaschbecken und eine Ergänzung zur ios Wanne. Auch in größeren Abmessungen erhältlich, siehe ios 80. Erhältlich in 7 Farboberflächen.

L'ios 54 è un lavabo senza montatura progettato per integrare la vasca ios. Disponibile anche in ampie dimensionivedi ios 80. Disponibile in sette finiture di colore.

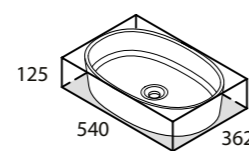

○ VB-IOS-54-NO
⚡ VB-IOS54-xx-NO
7Kg

SW  rich in Volcanic Limestone®





○ VB-IOS-80-NO   ▽ VB-IOS80-xx-NO  

  Massachusetts Code
cUPC listing by IAPMO

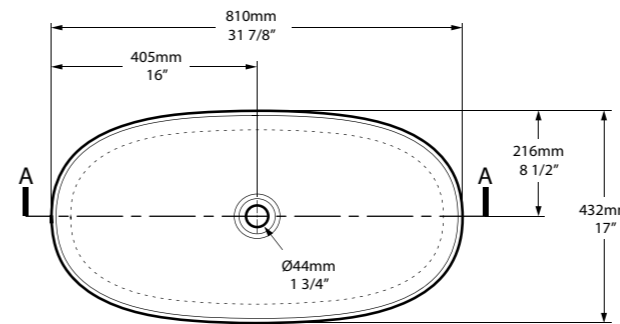

Top View

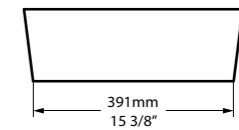

Side View

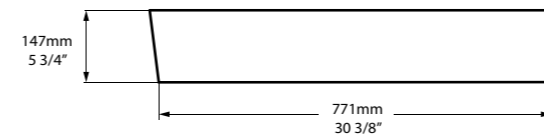

Front View

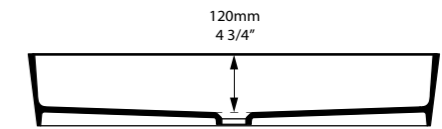

Section AA

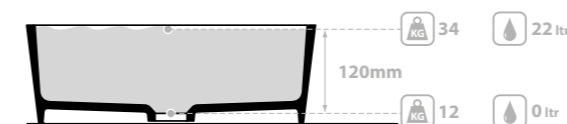

La vasque à poser ios 80 et ses proportions généreuses à été conçue pour accompagner la baignoire ios. Disponible dans des dimensions plus réduites, consulter ios 54. Disponible en sept couleurs.

ios 80 ist ein großzügig bemessenes Aufsatzwaschbecken und eine Ergänzung zur ios Wanne. Auch in kleineren Abmessungen erhältlich, siehe ios 54. Erhältlich in 7 Farboberflächen.

L'ios 80 e' un generoso lavabo progettato per complementare la vasca ios. Disponibile inoltre in piccole dimensioni - vedi ios 54. Disponibile in sette finiture di colore.

De ios 80 is een royale opzetwastafel passend bij het ios bad. Ook verkrijgbaar in een kleiner formaat- zie ios 54. Verkrijgbaar in zeven kleuren afwerkingen.

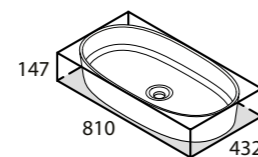

○ VB-IOS-80-NO
▽ VB-IOS80-xx-NO
12Kg

  rich in Volcanic Limestone®       





Massachusetts Code
cUPC listing by IAPMO

○ VB-MAU-42-NO ⚡ VB-MAU42-xx-NO

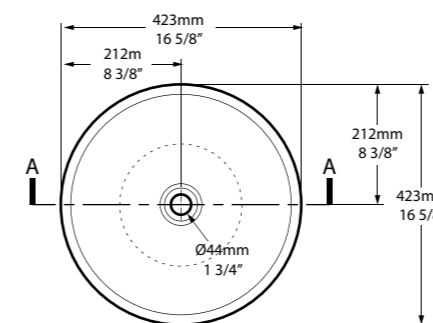

Top View

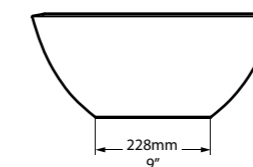

Side View

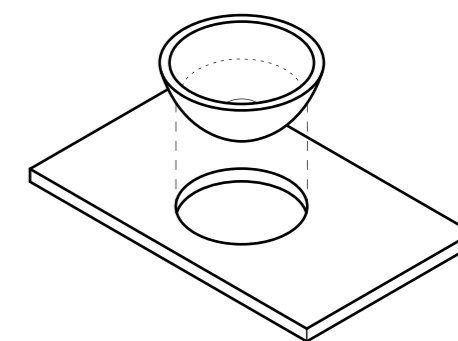
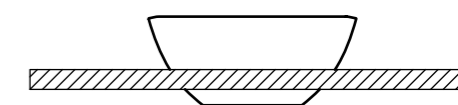

Semi Recessed

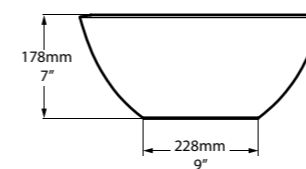

Front View

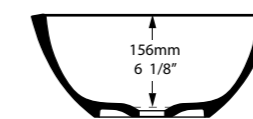

Section AA

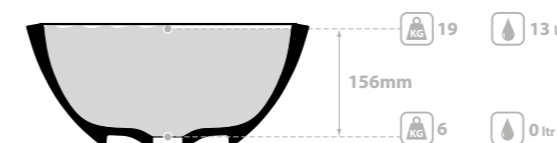

Une vasque hémisphérique et profonde aux dimensions généreuses, dotée d'un design sans rebord, adaptée à la pose sur plan ou semi-encastée. Idéale pour des aménagement en duo. Disponible en sept couleurs.

Een royaal ronde en diepe wasbak; geschikt voor opzet als ook half-verzonken installatie. Ideaal voor een 'hem en haar' setting. Verkrijgbaar in zeven kleuren afwerkingen.

Ein halbkugelförmig gestaltetes Becken mit randlosem Design und von großzügiger Tiefe. Sowohl als Aufsatzwaschbecken, als auch für den halb versenkten Einbau geeignet. Ideal als Doppelwaschtisch. Erhältlich in 7 Farboberflächen.

Un lavabo emisferico generosamente profondo con il design senza montatura; adatto per il montaggio ad appoggio o a semi-incasso. Ideale per una impostazione "lui" e "lei". Disponibile in sette finiture di colore.

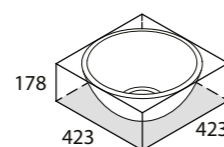

○ VB-MAU-42-NO
⚡ VB-MAU42-xx-NO
6Kg





Napoli 57

○ VB-NAP-57-NO  † VB-NAP57-xx-NO 

CE  Massachusetts Code
cUPC listing by IAPMO

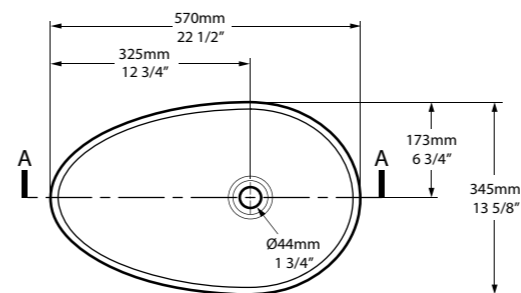

Side View

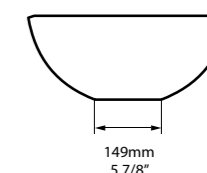

Top View

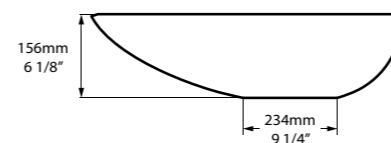

Front View



Section AA

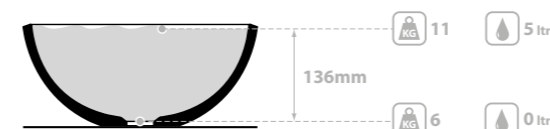

La vasque Napoli 57 et sa forme asymétrique est la pièce maîtresse de toutes les salles de bains. Conçue pour accompagner la baignoire en îlot Napoli. Disponible en sept couleurs.

Das eiförmige, asymmetrische Napoli 57 Becken wird in jedem Badezimmer zum Blickfang. Designed als Ergänzung zur freistehenden Napoli Wanne. Erhältlich in 7 Farboberflächen.

Il lavabo asimmetrico Napoli 57 a forma di uovo è un punto focale in ogni bagno. Progettato per completare la vasca freestanding Napoli. Disponibile in sette finiture di colore.

Het ei-vormige asymmetrische Napoli 57 wasbak is een centraal punt in een badkamer. Ontworpen om het Napoli bad aan te vullen. Verkrijgbaar in zeven kleuren afwerkingen.

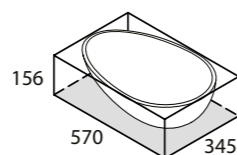

○ VB-NAP-57-NO
† VB-NAP57-xx-NO
6Kg

SW  rich in Volcanic Limestone





○ VB-RAD-51-NO  ⚡ VB-RAD51-xx-NO 

  Massachusetts Code cUPC listing by IAPMO

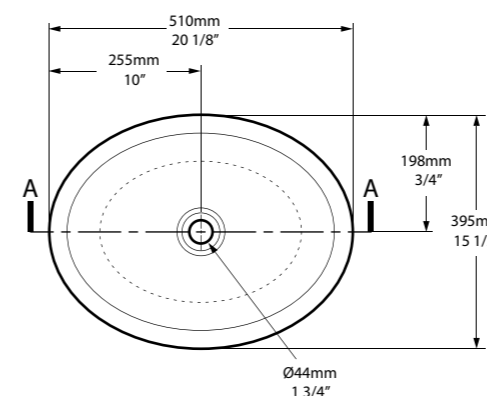

Top View

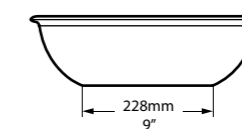

Side View

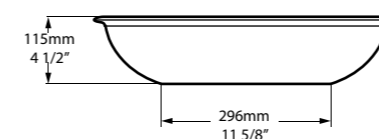

Front View

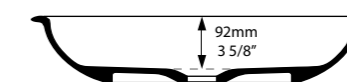

Section AA

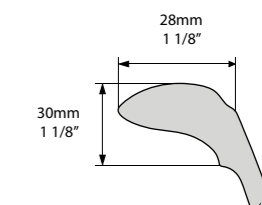

Rim Detail



La Radford 51 est une vasque à poser de style traditionnel avec un rebord tout en finesse. Conçue pour accompagner la baignoire en îlot Radford Disponible en sept couleurs.

De Radford 51 is een traditionele wasbak met subtiële rand detaillering. Passend bij het Radford bad. Verkrijgbaar in zeven kleuren afwerkingen.

Radford 51 ist ein traditionelles Aufsatzwaschbecken mit fein verziertem Rand. Designed als Ergänzung zur freistehenden Radford Wanne. Erhältlich in 7 Farboberflächen.

Il lavandino Radford 51 tradizionale con sottile dettgalio sul bordo che può essere montato ad appoggio o incasso. Disponibile in sette finiture di colore.

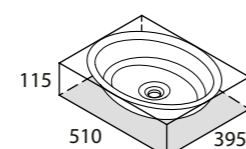

○ VB-RAD-51-NO
⚡ VB-RAD51-xx-NO
5Kg

  rich in Volcanic Limestone

 AN BK GR MB MW SG



Ravello 60

○ VB-RAV-60-NO  ↓ VB-RAV60-xx-NO 

CE  Massachusetts Code
cUPC listing by IAPMO

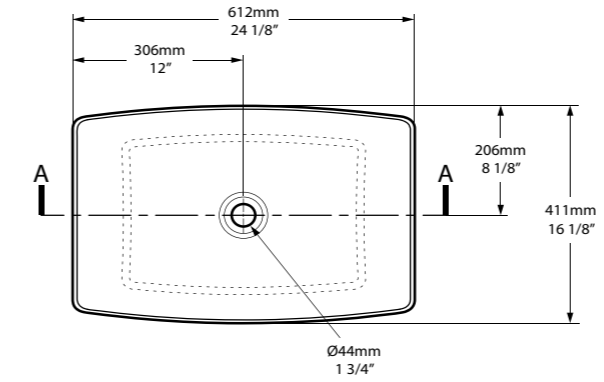

Top View

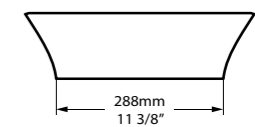

Side View

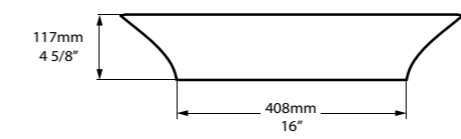

Front View

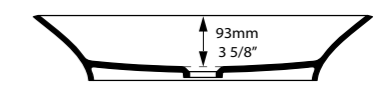

Section AA

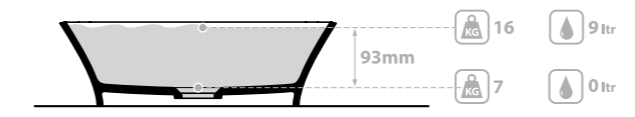

Les lignes sculpturales de la vasque Ravello 60 s'harmonisent avec la baignoire Ravello. Disponible en sept couleurs.

Die skulpturalen Linien des Ravello 60 Beckens entsprechen denen der Ravello Wanne. Erhältlich in 7 Farboberflächen.

Il lavabo Ravello 60 dalle linee scultoree completa la vasca Ravello. Disponibile in sette finiture di colore.

De Ravello 60 wasbak met zijn sculpturale lijnen is een aanvulling op het Ravello Bath. Verkrijgbaar in zeven kleuren afwerkingen.

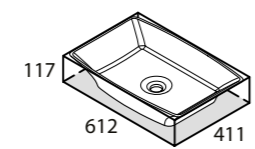

○ VB-RAV-60-NO
↓ VB-RAV60-xx-NO
7Kg

SW  rich in Volcanic Limestone

 AN BK GR MB MW SG

Recessed basins

La toute première gamme de vasques à encastrer QUARRYCAST® inclue des modèles à encastrer et d'autres à montage par dessous. Choisissez entre un style moderne ou plus traditionnel et bénéficiez de solutions d'installation modulables.

Die erste Produktreihe eingebauter QUARRYCAST® Waschbecken bietet Modelle zum halb oder voll versenkbaren Einbau. Wählen Sie zwischen modernen und traditionellen Stilrichtungen und profitieren Sie von den flexibel zu kombinierenden Möglichkeiten.

La prima gamma di lavabi QUARRYCAST® ad incasso include modelli che possono essere incassati o montati sottopiano. Scegli tra stili moderni e tradizionali, e scegli le opzioni di installazione flessibili disponibili.

De allereerste serie QUARRYCAST® inbouw wastafels bevat modellen die zowel als in- als onderbouw kunnen worden geïnstalleerd. U kunt kiezen uit moderne en traditionele stijlen, en profiteren van de flexibele installatie-opties.

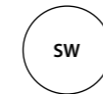

QUARRYCAST® Blanc
QUARRYCAST® Weiß.
QUARRYCAST® Bianco.
QUARRYCAST® Wit.

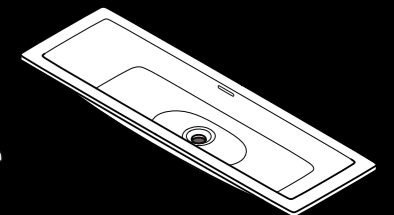
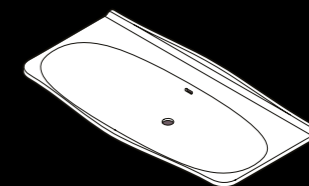
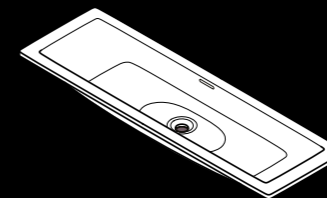
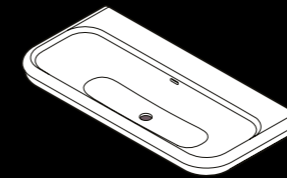
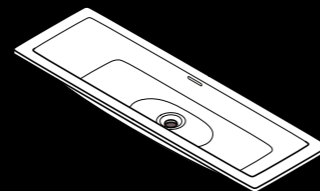
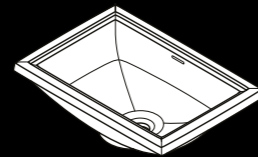
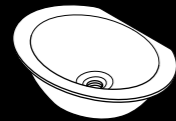

	Kaali 46	Pembroke 52	Rossendale 91
	464 x 355	512 x 351	916 x 382
	Page 178	Page 184	Page 186
Undermount	✓	✓	✓
Drop in		✓	✓

	Lario 100 Solo	Rossendale 107	Mandello 114 Solo	Rossendale 122
	999 x 479	1065 x 379	1145 x 579	1215 x 380
	Page 180	Page 188	Page 182	Page 190
		✓		✓
	✓	✓	✓	✓

Undermount / Encastrement par dessous / Unterbau / Sotto il top / Onderbouw.

Drop in / Encastrement par dessus / Einbau / A caduta / Inbouw.



○ UB-KAA-46-IO ☐

CE  Massachusetts Code Pending
cUPC listing by IAPMO Pending

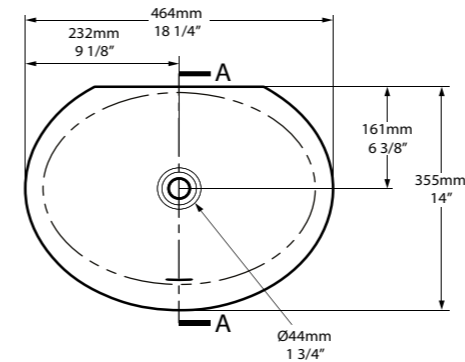

Top View

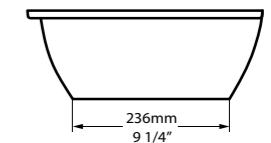

Side View

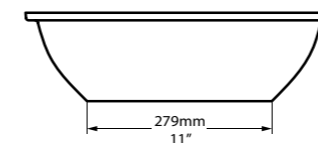

Front View

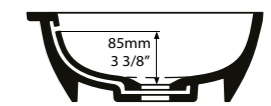

Section AA



Vasque ovale et profonde à encastrer sur un plan de travail au choix. Possède un trou de trop-plein. Egalement disponible en format lavabo - voir Metallo 61 Quartz.

Ein tiefes, ovales Waschbecken, wahlweise zum Unterbau, oder als Countertop. Mit internem Überlauf. Auch erhältlich zur Montage mit einem Waschbeckenständer. Siehe Metallo 61 Quartz.

Un lavabo ovale profondo progettato per un'installazione su un piano a scelta. Dispone di un troppopieno interno. Disponibile anche in formato lava mani-vedi Metallo 61 Quartz.

Een diep ovale wasbak voor onderbouw installatie in een wastafelblad naar keuze. Beschikt over een geïntegreerde overloop. Ook verkrijgbaar in compleet wastafelformaat - zie Metallo 61 Quartz.

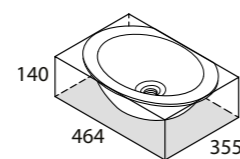

○ UB-KAA-46-IO
6Kg



SW  rich in Volcanic Limestone™



Lario 100 Solo

○ DB-LAR-N-100-IO DB-LAR-1TH-100-IO DB-LAR-3TH-100-IO ©

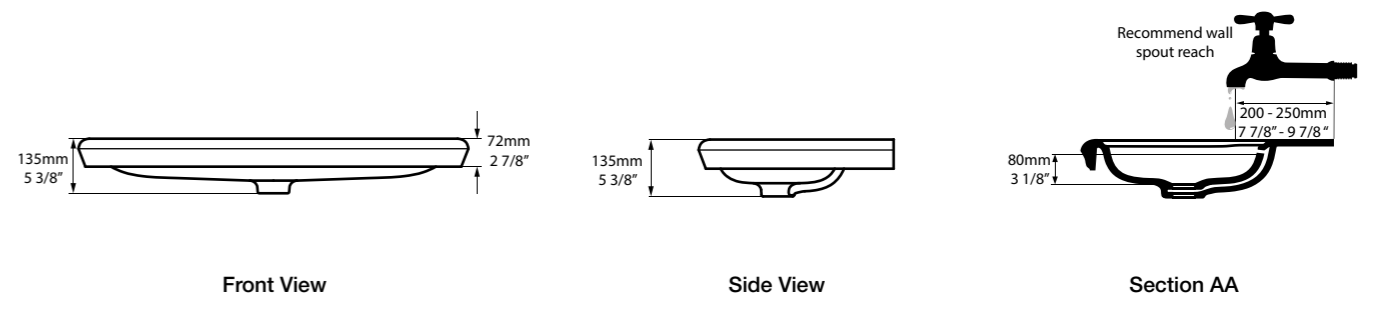
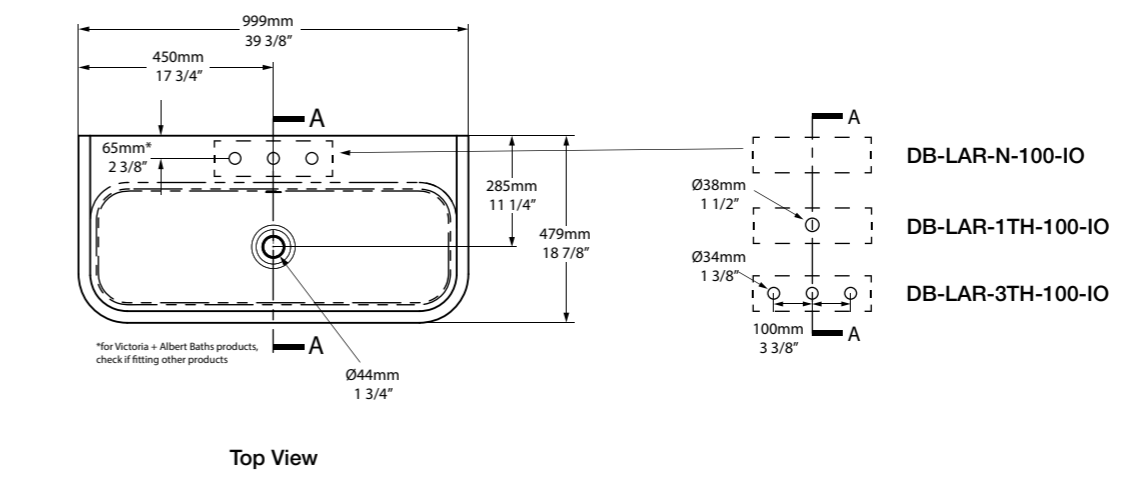

Une vasque traditionnelle dotée d'un rebord délicat, adaptée à la pose sur plan ou semi-encastée. Possède un trou de trop-plein. Pour découvrir les autres dimensions, consulter les pages mobilier et lavabos. Conçue par Meneghello Paoletti Associati.

Een traditionele wastafel met subtiële rand detaillering, voor opzetinstallatie of half verzonken. Inclusief geïntegreerde overloop. Zie ook de paginas omtrent badmeubels voor meerdere opties. Ontwerp van Meneghello Paoletti Associati.

Ein traditionell gestaltetes Becken mit feinen Randverzierungen, das als Aufsatzwaschbecken oder halb versenkt eingebaut werden kann. Mit internem Überlauf. Weitere Optionen finden Sie auf den Waschbeckenständer- und Möbelseiten. Designed von Meneghello Paoletti Associati.

Un lavabo tradizionale con bordo sottile a dettaglio che può essere montato ad appoggio o a semi incasso. Caratterizzato da un troppopieno interno. Per vedere questo modello in altri formati, si prega di fare riferimento alle pagine dei mobili e lavabi. Progettato da Meneghello Paoletti Associati.

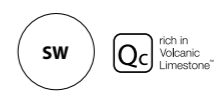
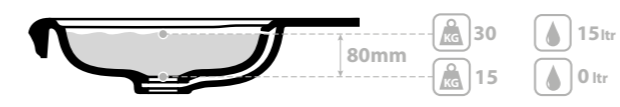
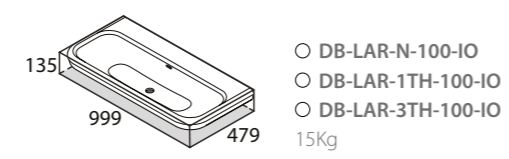



Mandello 114 Solo

○ DB-MAN-N-114-IO DB-MAN-1TH-114-IO DB-MAN-3TH-114-IO ⊙

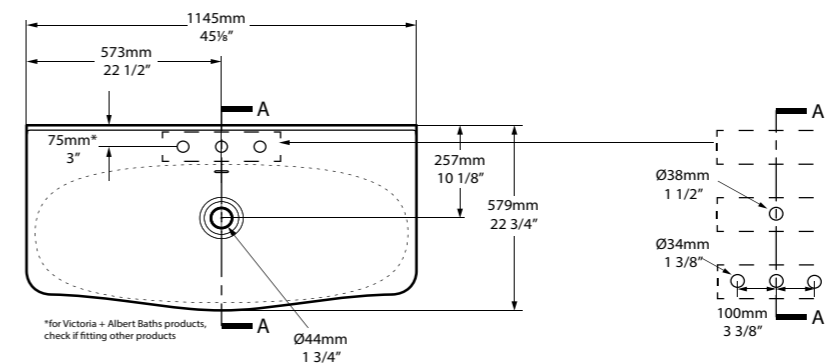

DB-MAN-N-114-IO
DB-MAN-1TH-114-IO
DB-MAN-3TH-114-IO

Top View



Front View

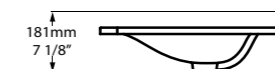

Side View

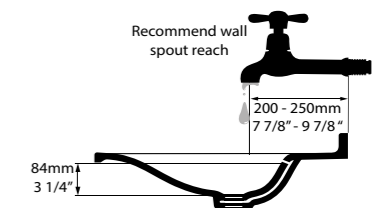

Section AA

Une vasque contemporaine aux lignes élégantes adaptée à la pose sur plan ou semi-encastée. Possède un trou de trop-plein. Pour découvrir les autres dimensions, consulter les pages mobilier et lavabos. Conçue par Meneghello Paoletti Associati.

Ein modernes Becken mit eleganten Linien, das als Aufsatzwaschbecken oder halb versenkt eingebaut werden kann. Mit internem Überlauf. Weitere Optionen finden Sie auf den Waschbeckenständer- und Möbelseiten. Designed von Meneghello Paoletti Associati.

Un lavabo contemporaneo dalle linee eleganti che può essere montato ad appoggio o semi incasso. Caratterizzato da un troppopieno interno. Per vedere questo modello in altri formati, si prega di fare riferimento alle pagine dei mobili e lavabi. Progettato da Meneghello Paoletti Associati

Een eigentijdse wastafel met elegante lijnen voor opzetinstallatie of half verzonken. Inclusief egintegreerde overloop. Zie ook de paginas omtrent badmeubels voor meerdere opties. Ontwerp van Meneghello Paoletti Associati.

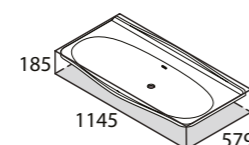

○ DB-MAN-N-114-IO
○ DB-MAN-1TH-114-IO
○ DB-MAN-3TH-114-IO
15Kg

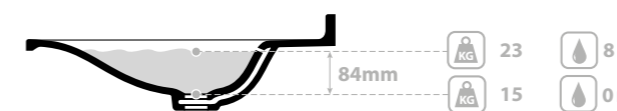



Pembroke 52

○ DU-PEM-52-IO 

CE  Massachusetts Code
cUPC listing by IAPMO

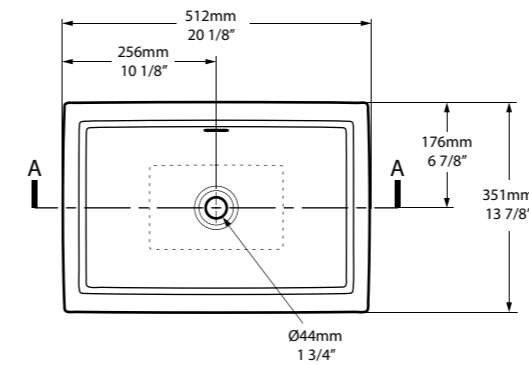

Top View

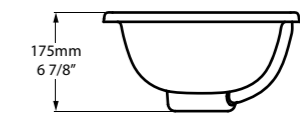

Side View

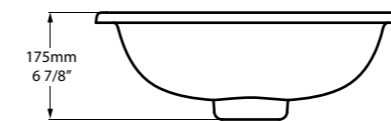

Front View

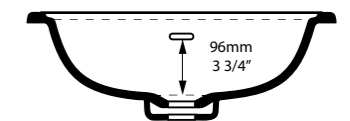
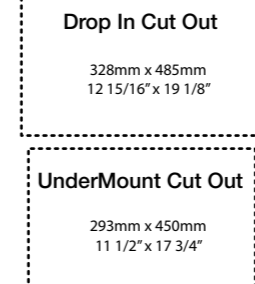

Section AA



Elegante vasque avec bordure et trop-plein intégré. Dispose d'un design caractérisé par un rebord spécial qui permet une installation sur le plan ou encastrée, au choix. Conçue par Meneghello Paoletti Associati.

Waschbecken mit elegantem Rand und integriertem Überlauf. Der speziell gestaltete Rand erlaubt für sowohl Unterbau oder Einbau Installation in eine Oberfläche Ihrer Wahl. Designed von Meneghello Paoletti Associati.

Elegante lavabo con bordo con troppopieno interno. Presenta un design speciale del bordo che permette un'installazione a scelta di piano. Progettato da Meneghello Paoletti Associati.

Elegante wasbak met geïntegreerde overloop. Geschikt voor inbouw alsook onderbouw installaties naar keuze. Ontworpen door Meneghello Paoletti Associati.

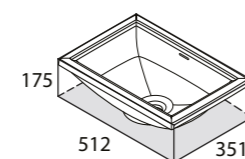

○ DU-PEM-52-IO
5Kg



SW  rich in
Volcanic
Limestone



Rossendale 91

○ DU-ROS-91-IO 

CE  Massachusetts Code cUPC listing by IAPMO

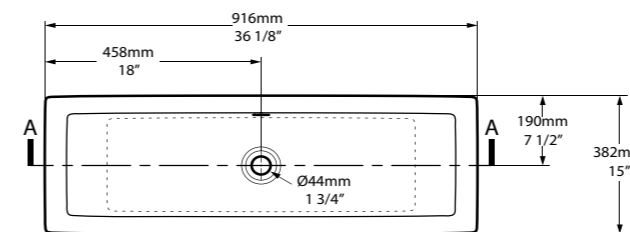

Top View

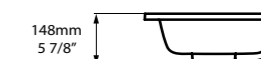

Side View

Drop In Cut Out

833mm x 340mm
32 3/4" x 13 3/8"

UnderMount Cut Out

779mm x 274mm
30 5/8" x 10 3/4"

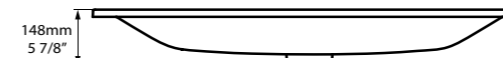

Front View

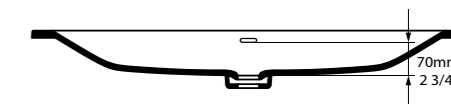

Section AA



La plus petite vasque de la collection Rossendale. Grande, peu profonde, elle est adaptée à la pose encastrée ou sous plan. Possède un trou de trop-plein. Disponible en trois dimensions - voir également Rossendale 107 et Rossendale 122.

Das kleinste unserer Rossendale Waschbecken. Ein langes, flaches Becken zur versenkten Installation, oder zum Unterbau. Mit internem Überlauf. Erhältlich in 3 Größen. Beachten Sie auch Rossendale 107 und Rossendale 122.

Il più piccolo dei nostri lavabi Rossendale. Un lavabo lungo che può essere incassato o montato sotto. Dispone di un troppopieno interno. Disponibile in tre formati-vedi inoltre Rossendale 107 e Rossendale 122.

De kleinste van onze Rossendale wasbakken. Een lange, ondiepe wasbak voor inbouw of onderbouw met geïntegreerde overloop. Verkrijgbaar in drie maten - zie ook Rossendale 107 en Rossendale 122.

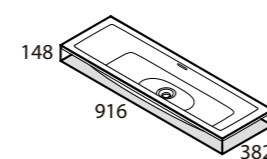

○ DU-ROS-91-IO
9Kg

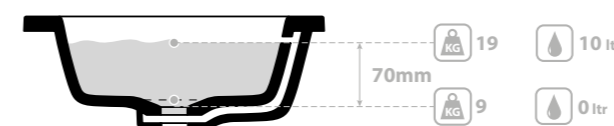

SW  rich in Volcanic Limestone™



NEW Rossendale 107 

○ DU-ROS-107-IO ©

CE  Massachusetts Code
cUPC listing by IAPMO

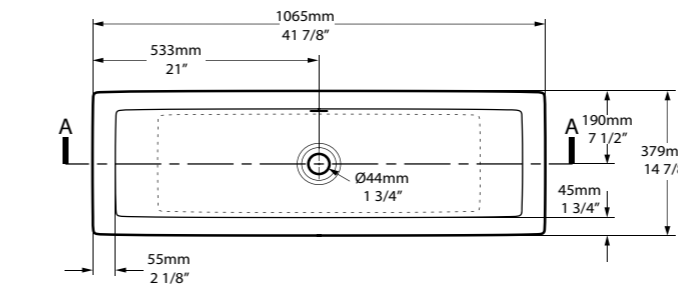

Top View

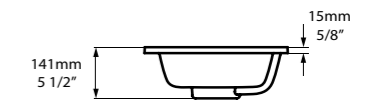

Side View

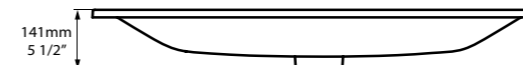
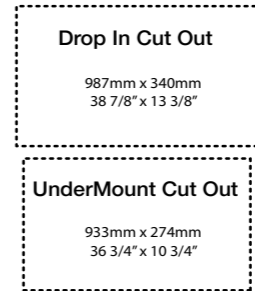

Front View

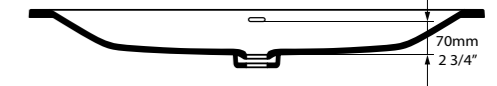

Section AA



Grande vasque, peu profonde, adaptée à la pose encastrée ou sous-plan. Possède un trou de trop-plein. Disponible en trois dimensions - voir également Rossendale 91 et Rossendale 122.

Ein langes, flaches Becken zur versenkten Installation, oder zum Unterbau. Mit internem Überlauf. Erhältlich in 3 Größen. Beachten Sie auch Rossendale 91 und Rossendale 122.

Un lavabo lungo che può essere incassato o montato sotto. Dispone di un troppopieno interno. Disponibile in tre formati-vedi inoltre Rossendale 91 e Rossendale 122.

Een lange, ondiepe wasbak voor inbouw of onderbouw met geïntegreerde overloop. Verkrijgbaar in drie maten - zie ook Rossendale 91 en Rossendale 122.

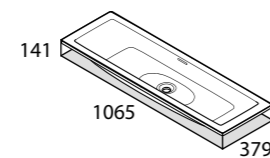

○ DU-ROS-107-IO
9Kg



SW  rich in Volcanic Limestone™



Rossendale 122

○ DU-ROS-122-IO ©

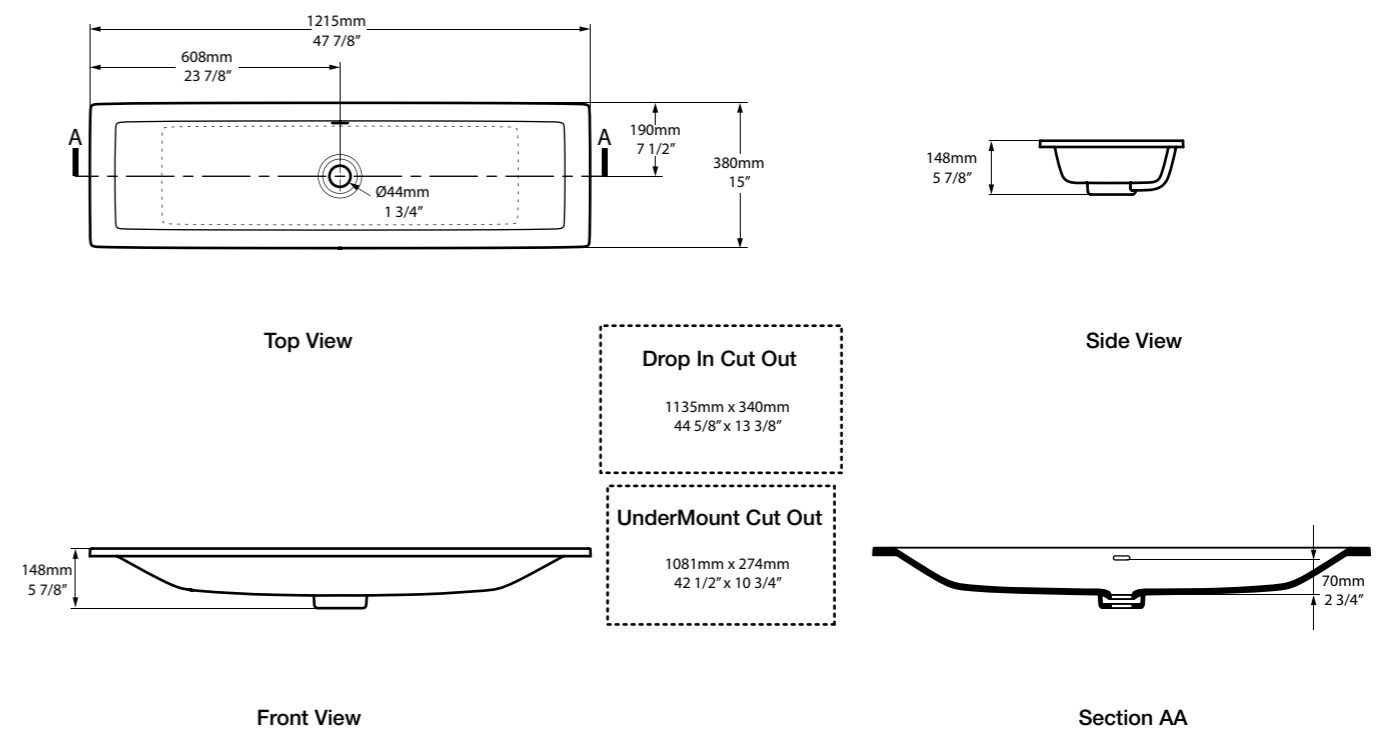

La plus généreuse vasque de la collection Rossendale. Grande mais peu profonde elle est adaptée à la pose encastrée ou sous plan. Possède un trou de trop-plein. Disponible en trois dimensions - voir également Rossendale 91 et Rossendale 107.

Das größte unserer Rossendale Waschbecken. Ein langes, flaches Becken zur versenkten Installation, oder zum Unterbau. Mit internem Überlauf. Erhältlich in 3 Größen. Beachten Sie auch Rossendale 91 und Rossendale 107.

Il piu' grande dei nostri lavabi Rossendale. Un lavabo lungo che può essere incassato o montato sotto. Dispone di un troppopieno interno. Disponibile in tre formati-vedi inoltre Rossendale 91 e Rossendale 107.

De grootste van onze Rossendale wasbakken. Een lange, ondiepe wasbak voor inbouw of onderbouw met geïntegreerde overloop. Verkrijgbaar in drie maten - zie ook Rossendale 91 en Rossendale 107.

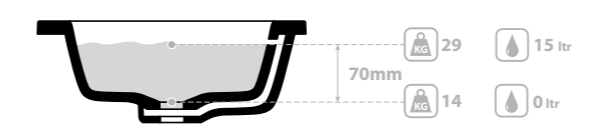
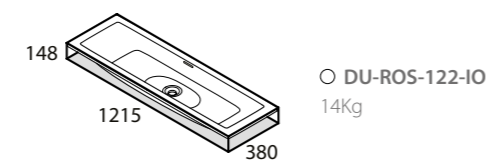

Washstands

Nouveauté 2018, nos lavabos s'accordent parfaitement aux intérieurs modernes ou traditionnels.

Choisissez entre deux styles : Candella, de style néoclassique, avec ses pieds délicatement enroulés ou Metallo, de style édouardien, avec ses détails profilés distinctifs. Découvrez les différentes options de vasques, incluant une étonnante surface en Quartz avec vasque encastrée ou l'une de nos généreuses vasques Solo. Cette collection a été conçue par Meneghello Paoletti Associati.

Neu in 2018 sind unsere Waschbeckenständer, die perfekt zu modernen und traditionellen Einrichtungen passen.

Wählen Sie zwischen 2 Stilen: Den neoklassizistischen Candella, mit seinen zart gewendelten Beinen, oder den edwardianischen Metallo, mit den charakteristischen Gelenken. Erkunden Sie die verschiedenen Waschbeckenoptionen, darunter ein eindrucksvolles Quartz Top mit Becken zum Unterbau, oder eines unserer großzügig bemessenen Solo Becken. Diese Kollektion wurde designed von Meneghello Paoletti Associati.

Novita' per il 2018, i nostri lavabi sono perfetti per interni moderni o tradizionali.

Scegli tra due stili; il neoclassico Candella con le gambe delicatamente tornite, o il metallo edwardiano, che presenta dettagli di giuntura distinti. Esplora le diverse opzioni di lavabo, che includono un top in quarzo con un lavabo sottomontato, o uno dei nostri lavabi Solo generosamente proporzionati. Questa collezione è stata progettata da Meneghello Paoletti Associati.

Onze nieuwe wastafels voor 2018, zijn perfect geschikt voor moderne of klassieke interieurs.

Kies uit twee stijlen; de neoklassieke Candella met subtiële en elegante poten, of de Edwardian Metallo, met kenmerkende verbindingen. Ontdek de verschillende wasafeloptyes, waaronder een opvallende Quartz-wastafelblad met een onderbouw wasbak, of één van onze royaal geproportioneerde Solo-wasbakken. Deze collectie is ontworpen door Meneghello Paoletti Associati.



PC
Chrome Poli.
Chrom Poliert.
Cromo Lucidato.
Chroom Glanzend.



QWH
Chromé & Blanc.
Chrom Poliert & Weiß.
Cromo Lucido & Bianco.
Chroom Glanzend & Wit.



QBK
Chromé & Noir.
Chrom Poliert & Schwarz.
Cromo Lucido & Nero.
Chroom Glanzend & Zwart.



QBT
Chromé & Biscuit.
Chrom Poliert & Biskuit.
Cromo Lucido & Biscotto.
Chroom Glanzend & Biscuit.



Metallo 61 Quartz

610 x 494

Page 202

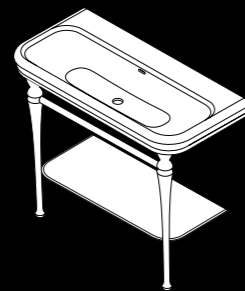

Candella 100

999 x 479

Page 194

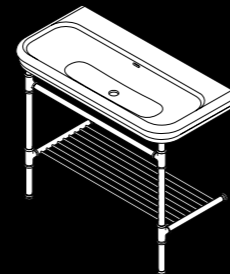

Metallo 100

999 x 479

Page 198

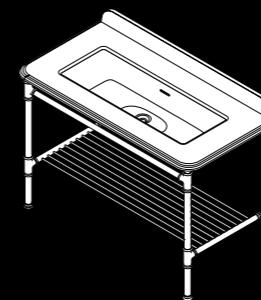

Metallo 113 Quartz

1125 x 515

Page 204

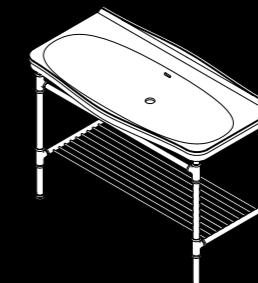

Metallo 114

1145 x 579

Page 200

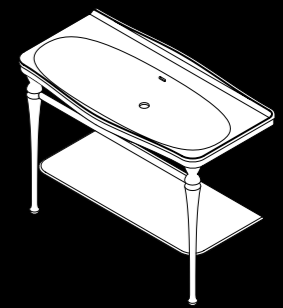

Candella 114

1145 x 579

Page 196



CAN-100-N-PC CAN-100-1TH-PC CAN-100-3TH-PC

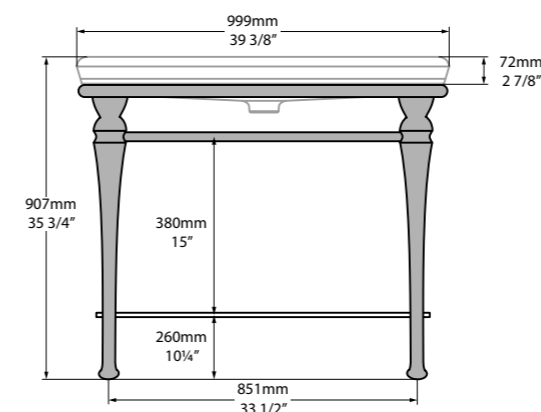

Front view

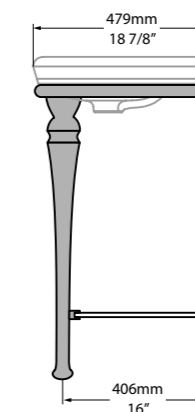

Side view

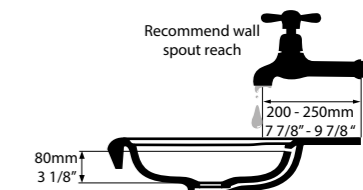

Section AA



Tap holes can be drilled by installer
 Armaturenlöcher können leicht vom Installateur gebohrt werden
 Les trous de robinetterie peuvent être percés par l'installateur
 Pueden ser perforados por el instalador
 I fori per rubinetti possono essere perforati dall'installatore

CAN-100-N-PC

CAN-100-1TH-PC

CAN-100-3TH-PC

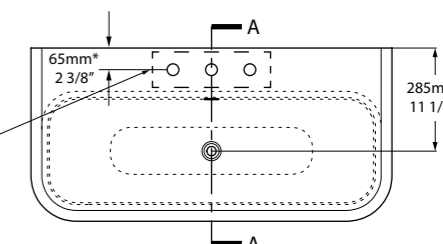
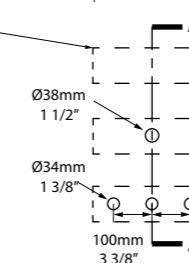

*for Victoria + Albert Baths products,
 check if fitting other products

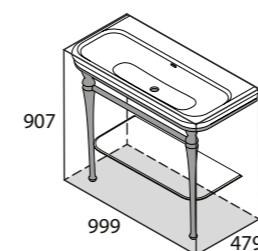

CAN-100-N-PC
 CAN-100-1TH-PC
 CAN-100-3TH-PC
 37½Kg



Lavabo chromé surmonté d'une vasque Lario 100 Solo.

- Possibilité de commander avec ou sans trou de robinetterie;
- Deux pieds aux détails de formes élégantes;
- Porte-serviette et étagère en verre trempé pour le rangement;
- Elements d'ancrage mural inclus.

Washbeckenständer in poliertem Chrom, mit dem Becken Lario 100 Solo.

- Mit oder ohne Armaturenlöcher erhältlich;
- Zwei Beine mit elegant geschwungenen Details;
- Handtuchhalter und ein Aufbewahrungsregal aus gehärtetem Glas;
- Inklusive Wandbefestigung.

Lavabo in cromo lucido sormontato da un lavabo Lario 100 Solo.

- Opzione per ordinare con o senza rubinetto/fori per rubinetto;
- Due gambe con eleganti dettagli;
- Portasciugamani e un ripiano in vetro temperato;
- Ancoraggi a muro inclusi.

Glans chromen onderstel met de Lario 100 Solo wasbak.

- Optioneel verkrijgbaar met of zonder kraangaten;
- Twee poten met elegant gevormde details;
- Handdoek rail en planchet van gehard glas;
- Muurankers inbegrepen.



CAN-114-N-PC CAN-114-1TH-PC CAN-114-3TH-PC

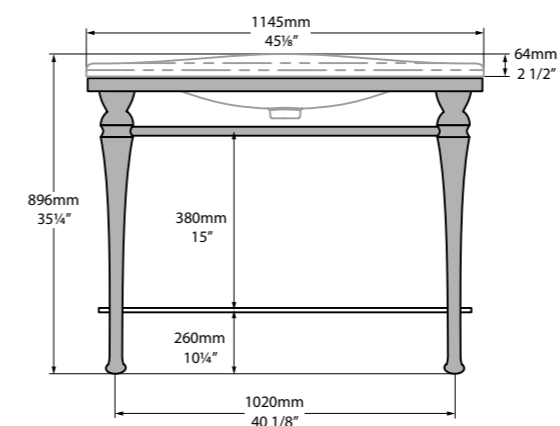

Front view

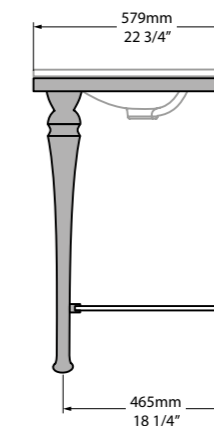

Side view

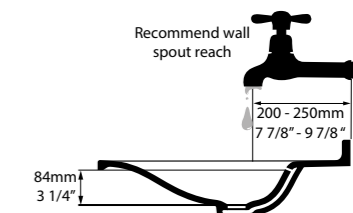

Section AA



Tap holes can be drilled by installer
 Armaturenlöcher können leicht vom Installateur gebohrt werden
 Les trous de robinetterie peuvent être percés par l'installateur
 Pueden ser perforados por el instalador
 I fori per rubinetti possono essere perforati dall'installatore

CAN-114-N-PC

CAN-114-1TH-PC

CAN-114-3TH-PC

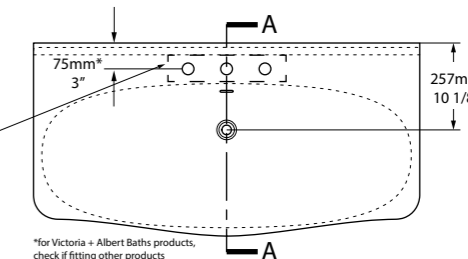
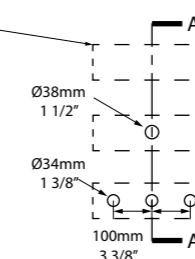

*for Victoria + Albert Baths products,
 check if fitting other products

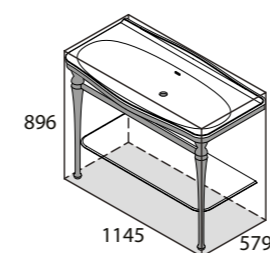

CAN-114-N-PC
 CAN-114-1TH-PC
 CAN-114-3TH-PC
 37 1/2 Kg



Lavabo chromé surmonté d'une vasque Mandello 114 Solo.

- Possibilité de commander avec ou sans trou de robinetterie;
- Deux pieds aux détails de formes élégantes;
- Porte-serviette et étagère en verre trempé pour le rangement;
- Elements d'ancrage mural inclus.

Waschbeckenständer in poliertem Chrom, mit dem Becken Mandello 114 Solo.

- Mit oder ohne Armaturenlöcher erhältlich;
- Zwei Beine mit elegant geschwungenen Details;
- Handtuchhalter und ein Aufbewahrungsregal aus gehärtetem Glas;
- Inklusive Wandbefestigung.

Lavabo in cromo lucido sormontato da un lavabo Mandello 114 Solo.

- Opzione per ordinare con o senza rubinetto/fori per rubinetto;
- Due gambe con eleganti dettagli;
- Portasciugamani e un ripiano in vetro temperato;
- Ancoraggi a muro inclusi.

Glans chromen onderstel met de Mandello 114 Solo wasbak.

- Optioneel verkrijgbaar met of zonder kraangaten;
- Twee poten met elegant gevormde details;
- Handdoek rail en planchet van gehard glas;
- Muurankers inbegrepen.



MET-N-100-xx-IO MET-1TH-100-xx-IO MET-3TH-100-xx-IO

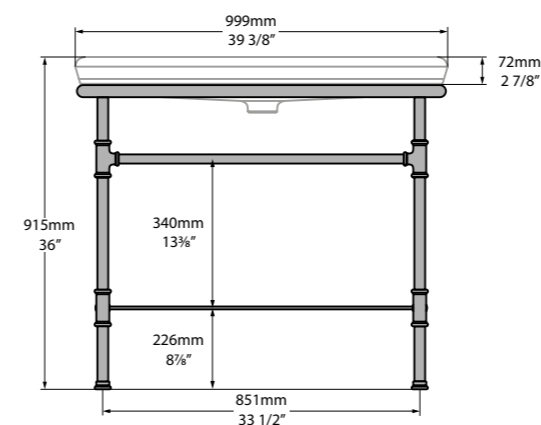

Front view

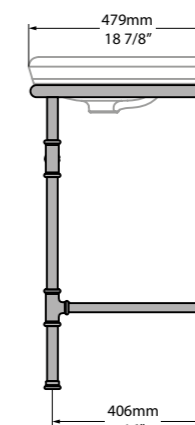

Side view

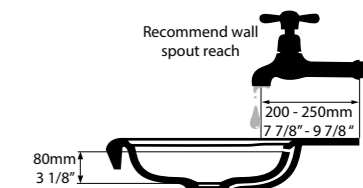

Section AA



Tap holes can be drilled by installer
 Armaturenlöcher können leicht vom Installateur gebohrt werden
 Les trous de robinetterie peuvent être percés par l'installateur
 Pueden ser perforados por el instalador
 I fori per rubinetti possono essere perforati dall'installatore

MET-N-100-xx-IO

MET-1TH-100-xx-IO

MET-3TH-100-xx-IO

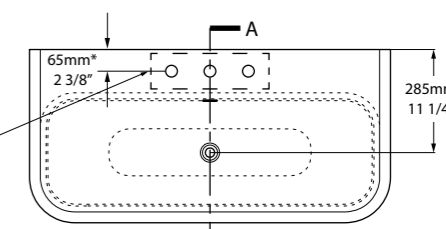
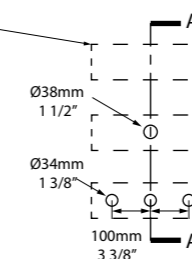

*for Victoria + Albert Baths products,
 check if fitting other products

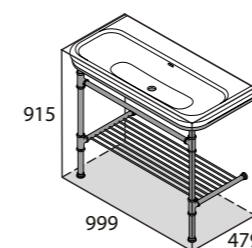

MET-100-N-xx-IO
 MET-100-1TH-xx-IO
 MET-100-3TH-xx-IO
 30Kg



Lavabo chromé surmonté d'une vasque Lario 100 Solo.

- Possibilité de commander avec ou sans trou de robinetterie;
- Deux pieds avec finition des jointures en T;
- Porte-serviette et support pour le rangement;
- Elements d'ancrage mural inclus.

Waschbeckenständer in poliertem Chrom, mit dem Becken Lario 100 Solo.

- Mit oder ohne Armaturenlöcher erhältlich;
- Zwei Beine mit charakteristischen Gelenken;
- Handtuchhalter und Aufbewahrungsregal;
- Inklusive Wandbefestigung.

Lavabo in cromo lucido sormontato da un lavabo Lario 100 Solo.

- Opzione per ordinare con o senza rubinetto/fori per rubinetto;
- Due gambe (in cromo lucido) con giunto a "T" ad incastro;
- Portasciugamani e un ripiano;
- Ancoraggi a muro inclusi.

Glans chromen onderstel met de Lario 100 Solo wasbak.

- Optioneel verkrijgbaar met of zonder kraangaten;
- Twee poten met T-stuk verbindingen;
- Handdoek rail en planchet;
- Muurankers inbegrepen.



MET-114-N-PC MET-114-1TH-PC MET-114-3TH-PC

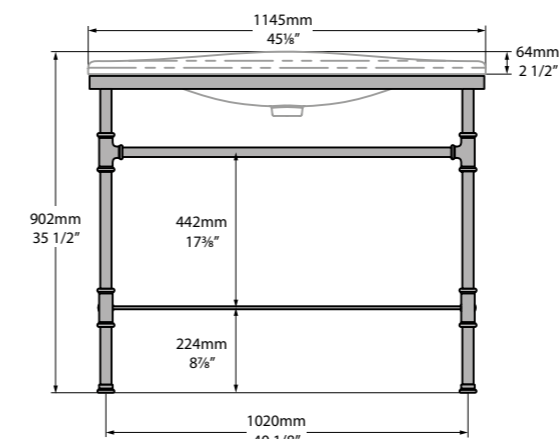

Front view

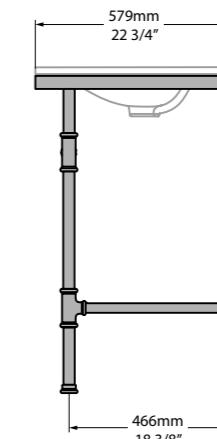

Side view

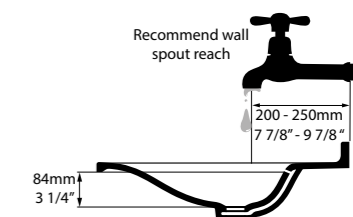

Section AA



Tap holes can be drilled by installer
 Armaturenlöcher können leicht vom Installateur gebohrt werden
 Les trous de robinetterie peuvent être percés par l'installateur
 Pueden ser perforados por el instalador
 I fori per rubinetti possono essere perforati dall'installatore

MET-114-N-PC

MET-114-1TH-PC

MET-114-3TH-PC

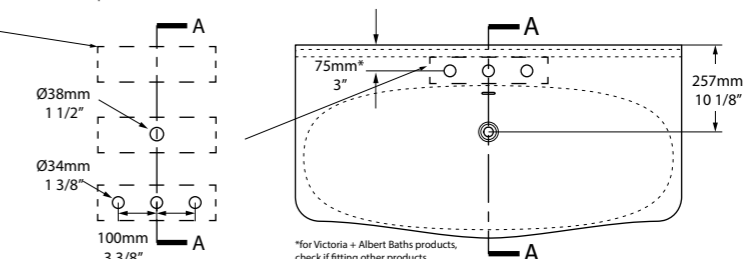

*for Victoria + Albert Baths products,
 check if fitting other products

Lavabo chromé surmonté d'une vasque Mandello 114 Solo.

- Possibilité de commander avec ou sans trou de robinetterie;
- Deux pieds avec finition des jointures en T;
- Porte-serviette et support pour le rangement;
- Elements d'ancrage mural inclus.

Waschbeckenständer in poliertem Chrom, mit dem Becken Mandello 114 Solo.

- Mit oder ohne Armaturenlöcher erhältlich;
- Zwei Beine mit charakteristischen Gelenken;
- Handtuchhalter und Aufbewahrungsregal;
- Inklusive Wandbefestigung.

Lavabo in cromo lucido sormontato da un lavabo Mandello 114 Solo.

- Opzione per ordinare con o senza rubinetto/fori per rubinetto;
- Due gambe (in cromo lucido) con giunto a "T" ad incastro;
- Portasciugamani e un ripiano;
- Ancoraggi a muro inclusi.

Glans chromen onderstel met de Mandello 114 Solo wasbak.

- Optioneel verkrijgbaar met of zonder kraangaten;
- Twee poten met T-stuk verbindingen;
- Handdoek rail en planchet;
- Muurankers inbegrepen.

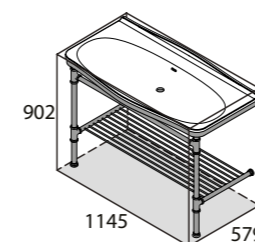

MET-114-N-PC
 MET-114-1TH-PC
 MET-114-3TH-PC
 30Kg





NEW

Metallo 61 Quartz

MET-61-Qxx-N-PC MET-61-Qxx-1TH-PC MET-61-Qxx-3TH-PC



Massachusetts Code Pending
cUPC listing by IAPMO Pending

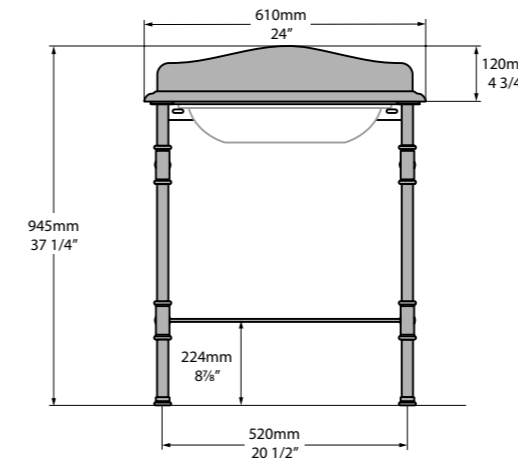

Front view

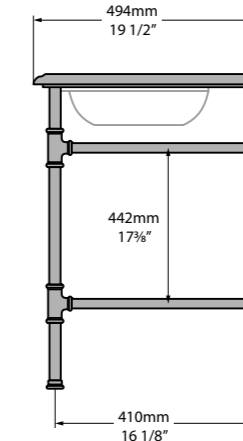

Side view

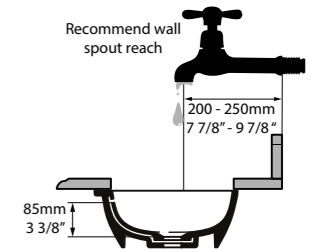

Section AA



Tap holes can be drilled by installer
Armaturenlöcher können leicht vom Installateur gebohrt werden
Les trous de robinetterie peuvent être percés par l'installateur
Pueden ser perforados por el instalador
I fori per rubinetti possono essere perforati dall'installatore

MET-61-Qxx-N-PC

MET-61-Qxx-1TH-PC

MET-61-Qxx-3TH-PC

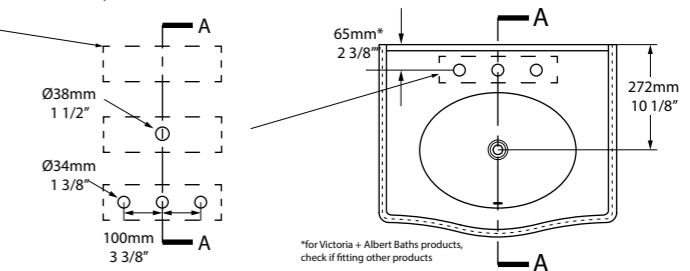

*for Victoria + Albert Baths products,
check if fitting other products

Lavabo avec surface en Quartz et vasque encastrée Kaali 46.

- Au choix : surface en Quartz Blanche, Noire ou Biscuit.
- Crédence amovible dans le même matériau de finition;
- Possibilité de commander avec ou sans trou de robinetterie;
- Deux pieds chromés avec finition des jointures en T;
- Porte-serviette et support pour le rangement;
- Elements d'ancrage mural inclus.

Waschbeckenständer mit Quartz Top und untermontiertem
Waschbecken Kaali 46.

- Quartz Top wahlweise in Weiß, Schwarz oder Biscuit;
- Abnehmbarer Überstand aus dem gleichen Oberflächenmaterial;
- Mit oder ohne Armaturenlöcher erhältlich;
- Zwei Beine aus poliertem Chrom mit markanten T-Stücken;
- Handtuchhalter und Aufbewahrungsregal;
- Inklusive Wandbefestigung.

Lavabo quarzo-sormontato con un lavabo sottomontato Kaali 46.

- Scelta di top in quarzo Bianco, Nero o Biscotto;
- Alzata removibile nella stessa finitura di materiale;
- Opzione per ordinare con o senza rubinetto/fori per rubinetto;
- Due gambe (in cromo lucido) con giunto a "T" ad incastro;
- Portasciugamani e un ripiano;
- Ancoraggi a muro inclusi.

Quartz wastafelblad met onderstel, inclusief Kaali 46
onderbouw wasbak.

- Quartz wastafelblad naar keuze in Wit, Zwart of Biscuit;
- Verwijderbare opstand in dezelfde materiaalafwerking;
- Optioneel verkrijgbaar met of zonder kraangaten;
- Twee glans chromen poten met T-stuk verbindingen;
- Handdoek rail en planchet;
- Muurankers inbegrepen.

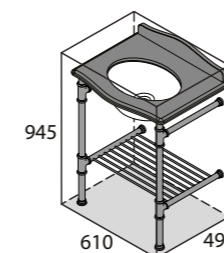

MET-61-Qxx-N-PC
MET-61-Qxx-1TH-PC
MET-61-Qxx-3TH-PC
31Kg





NEW Metallo 113 Quartz

MET-113-Qxx-N-PC MET-113-Qxx-1TH-PC MET-113-Qxx-3TH-PC

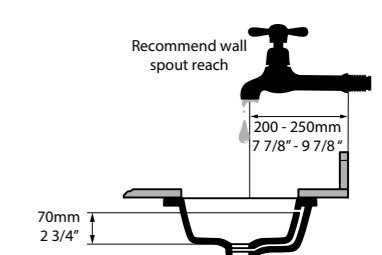
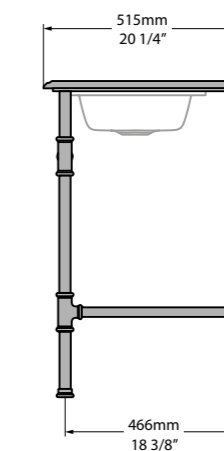
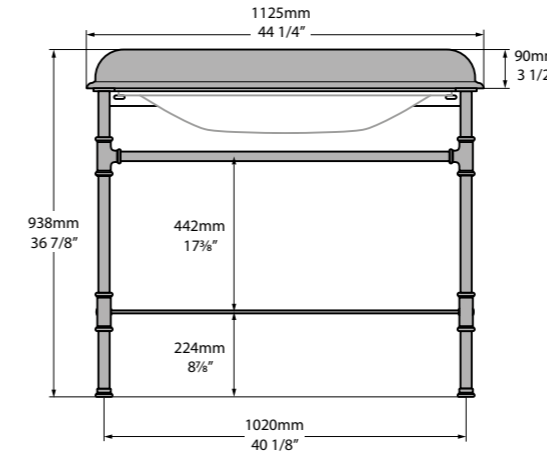

Front view

Side view

Section AA

Tap holes can be drilled by installer
 Armaturenlöcher können leicht vom Installateur gebohrt werden
 Les trous de robinetterie peuvent être percés par l'installateur
 Pueden ser perforados por el instalador
 I fori per rubinetti possono essere perforati dall'installatore

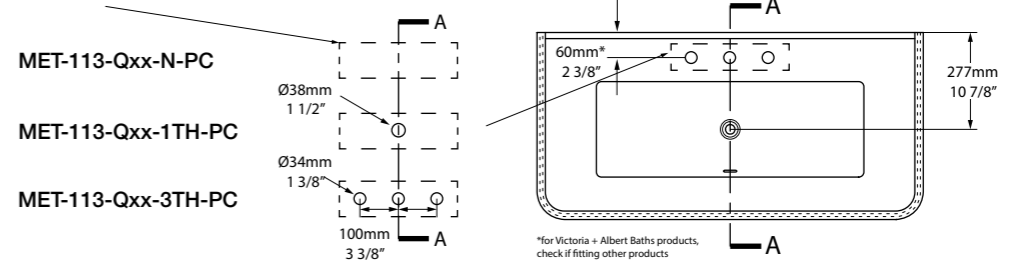

MET-113-Qxx-N-PC

MET-113-Qxx-1TH-PC

MET-113-Qxx-3TH-PC

*for Victoria + Albert Baths products, check if fitting other products

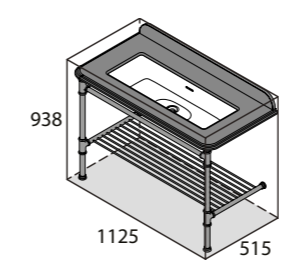
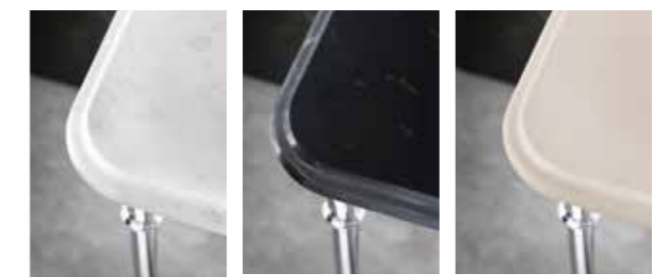

MET-113-Qxx-N-PC
 MET-113-Qxx-1TH-PC
 MET-113-Qxx-3TH-PC
 45Kg



Lavabo avec surface en Quartz et vasque encastrée Rossendale 91.

- Au choix : surface en Quartz Blanche, Noire ou Biscuit;
- Crédence amovible dans le même matériau de finition;
- Possibilité de commander avec ou sans trou de robinetterie;
- Deux pieds chromés avec finition des jointures en T;
- Porte-serviette et support pour le rangement;
- Elements d'ancrage mural inclus.

Washbeckenständer mit Quartz Top und untermontiertem Waschbecken Rossendale 91.

- Quartz Top wahlweise in Weiß, Schwarz oder Biscuit;
- Abnehmbarer Überstand aus dem gleichen Oberflächenmaterial;
- Mit oder ohne Armaturenlöcher erhältlich;
- Zwei Beine aus poliertem Chrom mit markanten T-Stücken;
- Handtuchhalter und Aufbewahrungsregal;
- Inklusive Wandbefestigung.

Lavabo quarzo-sormontato con un lavabo sottomontato Rossendale 91.

- Scelta di top in quarzo Bianco, Nero o Biscotto;
- Alzata removibile nella stessa finitura di materiale;
- Opzione per ordinare con o senza rubinetto/fori per rubinetto;
- Due gambe (in cromo lucido) con giunto a "T" ad incastro;
- Portasciugamani e un ripiano;
- Ancoraggi a muro inclusi.

Quartz wastafelblad met onderstel, inclusief Rossendale 91 onderbouw wasbak.

- Quartz wastafelblad naar keuze in Wit, Zwart of Biscuit;
- Verwijderbare opstand in dezelfde materiaalafwerking;
- Optioneel verkrijgbaar met of zonder kraangaten;
- Twee glans chromen poten met T-stuk verbindingen;
- Handdoek rail en planchet;
- Muurankers inbegrepen.

Furniture

De superbes meubles de salle de bain riches en détails; vous y trouverez des assemblages en queue d'aronde, des rangements spacieux au design élégant. Les meubles sont fabriqués au Royaume-Uni, en utilisant des techniques traditionnelles et sont certifiés FSC.

Exklusive Badkommoden mit durchdachten Details: Sie bieten Schwalbenschwanzverbindungen, großzügig bemessenen Stauraum und elegantes Design. Die Möbel sind „made in UK“ und werden nach traditionellen Herstellungstechniken aus FSC zertifizierten Hölzern gefertigt.

Nei nostri mobiletti da bagno esclusivi è tutta una questione di dettagli; troverete giunti a coda di rondine, immagazzinaggio generoso e design elegante. L'arredamento è creato nel Regno Unito con tecniche tradizionali e legname FSC-approvato.

Bij exclusieve badmeubels gaat het allemaal over details zoals zwaluwstaartverbindingen, royale opberg ruimte en elegant design. Het meubilair is gemaakt in het Verenigd Koninkrijk met behulp van traditionele technieken en FSC-goedgekeurd hout.



AN
Gris Anthracite.
Anthrazit.
Antracite.
Antraciet.



BK
Noir Brillant.
Schwarz Lack.
Nero Lucido.
Zwart Glans.



GR
Gris Clair.
Hellgrau.
Grigio Chiaro.
Licht Grijs.



SG
Gris Pierre.
Steingrau.
Grigio Pietra.
Steen Grijs.



GW
Blanc Laqué.
Weiß Lack.
Bianco Lucido.
Wit Glanzend.

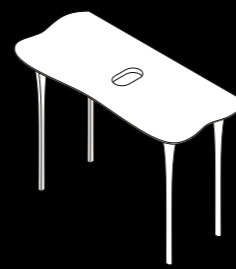
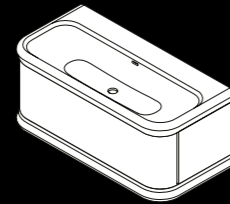
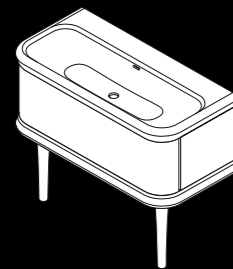

Lario 100

Lario 100 Volo

Stiletto 110 Glass

999 x 479

999 x 479

1100 x 497

Page 210

Page 210

Page 230

Basin top
Storage

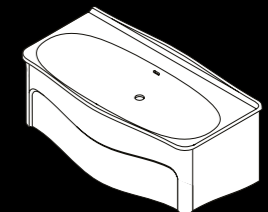
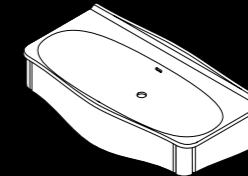
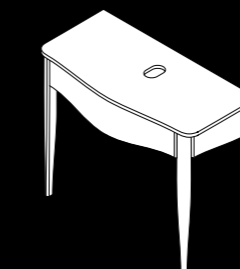

Lavello 114 Glass

Lavello 114 Volo

Mandello 114 Volo

1134 x 568

1145 x 579

1145 x 579

Page 220

Page 216

Page 224

Basin top
Storage

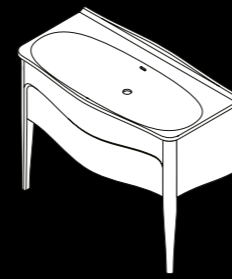
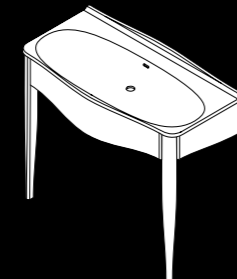
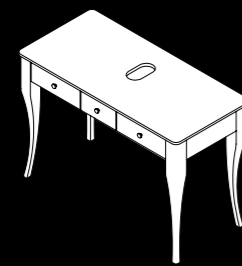

Bosa 112 Glass

Lavello 114

Mandello 114

1119 x 551

1145 x 579

1145 x 579

Page 208

Page 216

Page 224

Basin top
Storage

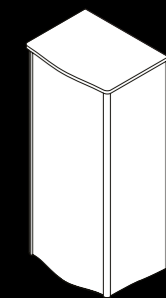
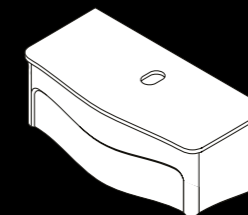
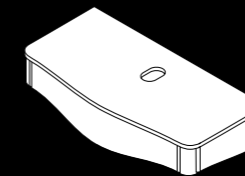

Lavello 114 Volo Glass

Mandello 114 Volo Glass

Lavello 40 Armadio

1134 x 568

1134 x 568

397 x 295 x 829

Page 220

Page 228

Page 214

Basin top
Storage



Basin top / Vasque / Becken / Lavabo / Wasbak.

Storage / Espace de rangement / Lager / Conservazione / Opslagruimte.



La Bosa 112 Glass est une console traditionnelle. Dotée d'un tiroir unique sur toute la largeur en bois de merisier, avec facade 3 tiroirs.

- Plan de vasque surmonté d'un plateau en verre trempé adapté à toutes les vasques Victoria + Albert (non inclus);
- Perforation pour kit de vidage, avec ou sans trou de robinetterie (en option à la commande);
- Quatre pieds ajustables pour un positionnement parfait au sol;
- Disponible en Gris Pierre ou Blanc Laqué;

Bosa 112 Glass ist ein traditioneller Badmöbel Waschtisch. Die einzelne, über die ganze Breite laufende Schublade ist aus massivem Kirschholz.

- Die Waschtischauflage ist aus gehärtetem Glas, und passend zu allen Victoria + Albert Aufsatzbecken (nicht inklusive);
- Die Abflussöffnung ist vorgebohrt, die Löcher für die Armaturen auf Wunsch;
- Vier höhenverstellbare FüÙe für einen perfekten Stand;
- Erhältlich in Hellgrau und Weiß Lack.

Bosa 112 Glass e' un tavolo da toeletta tradizionale in vetro. Caratterizzato da un singolo cassetto in legno massello di ciliegio con 3 finti cassetti.

- Vanity top in vetro temperato adatta per tutti i lavabi di Victoria + Albert (non incluso);
- Forato per kit di scarico, con la possibilità di averlo con o senza fori per il rubinetto;
- Quattro piedini regolabili per un perfetto livellamento;
- Disponibile in Grigio Chiaro e Bianco Lucido.

De Bosa 112 Glass is een traditioneel badmeubel. Beschikt over één lade over de volle breedte in massief kersenhout.

- Geharde glastop geschikt voor alle Victoria + Albert wastafels (niet inbegrepen);
- Voorgeboord afvoergat, met opties om met of zonder kraangaten te bestellen;
- Vier verstelbare poten voor een perfecte stabiliteit;
- Verkrijgbaar in Licht Grijs en Wit Glanzend.



BOS-N-112-xx BOS-1TH-112-xx

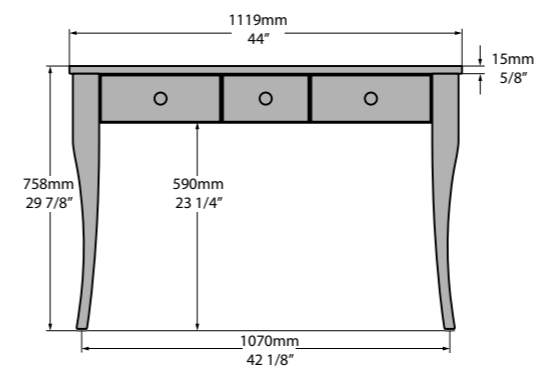

Front View

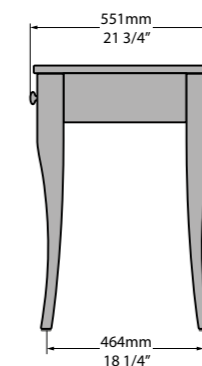

Side View

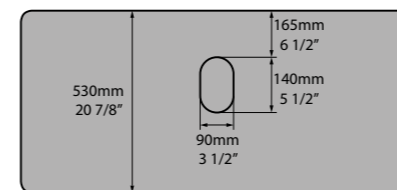

BOS-N-112-xx

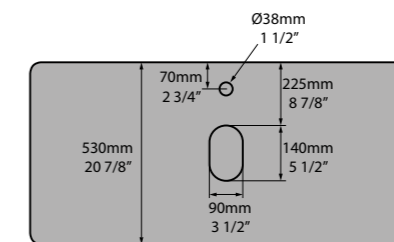

BOS-1TH-112-xx

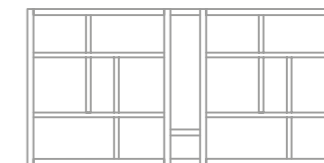

Drawer layout

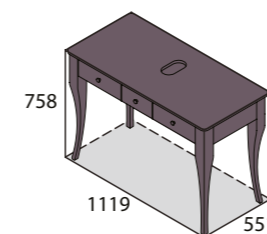

BOS-N-112-xx
BOS-1TH-112-xx
48½Kg





Jupe caractéristique en "QUARRYCAST", tiroir "push-to-open" (ouverture par simple pression) en merisier massif proposant un généreux espace de rangement et des séparateurs amovibles.

- Lario 100 - Avec vasque en QUARRYCAST®, deux pieds;
- Lario 100 Volo - Meuble suspendu avec vasque en QUARRYCAST®;
- Possibilité de commander avec ou sans trou de robinetterie;
- Disponible en Gris Pierre ou Anthracite.

Mit einer markanter QUARRYCAST® Umrandung, push-to-open Kirschholzschrublade inklusive großzügigem Stauraum und beweglichen Schubladenteilern.

- Lario 100 mit QUARRYCAST® Becken und 2 Füße;
- Lario 100 Volo zur Wandmontage mit QUARRYCAST® Becken;
- Optional mit, oder ohne Armaturenlöcher;
- Erhältlich in Steingrau oder Anthrazit.

Dispone di una "gonna" in QUARRYCAST®, cassetti in legno massello di ciliegio con spazio generoso e divisori per cassetto estraibili.

- Lario 100 con un lavabo in QUARRYCAST®, con due gambe;
- Lario 100 Volo montato a muro con lavabo in QUARRYCAST®;
- Opzione per ordinare con o senza fori di rubinetto;
- Disponibile in Grigio Pietra o Antracite.

Voorzien van een opvallende QUARRYCAST® "plint", push to open massief kersenhouten lade met royale bergruimte en verwijderbare lade-indelingen.

- Lario 100 met een QUARRYCAST® wastafel, met twee poten;
- Lario 100 Volo - voor wandmontage, met een QUARRYCAST® wastafel;
- Optioneel te bestellen met of zonder kraangaten;
- Verkrijgbaar in Steen Grijs en Antraciet.



LAR-N-100-xx-IO LAR-1TH-100-xx-IO LAR-3TH-100-xx-IO

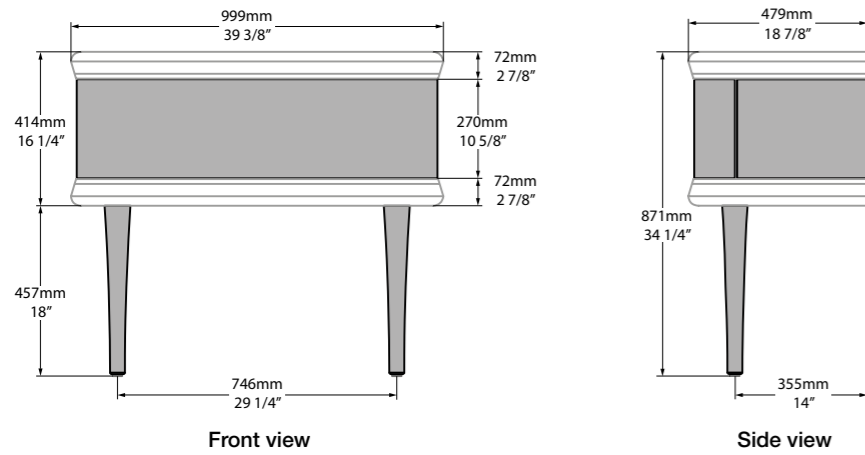

Tap holes can be drilled by installer
 Armaturenlöcher können leicht vom Installateur gebohrt werden
 Les trous de robinetterie peuvent être percés par l'installateur
 Pueden ser perforados por el instalador
 I fori per rubinetti possono essere perforati dall'installatore

LAR-N-100-xx-IO
 LAR-1TH-100-xx-IO
 LAR-3TH-100-xx-IO

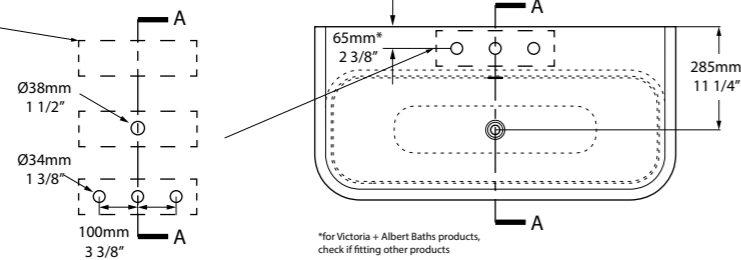

*for Victoria + Albert Baths products, check if fitting other products

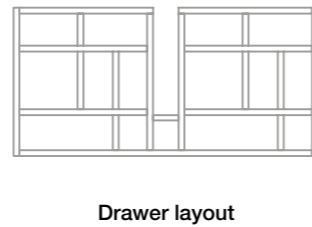

Drawer layout

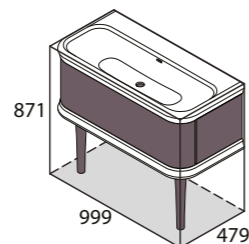

LAR-N-100-xx-IO
 LAR-1TH-100-xx-IO
 LAR-3TH-100-xx-IO
 43½Kg



LARV-N-100-xx-IO LARV-1TH-100-xx-IO LARV-3TH-100-xx-IO

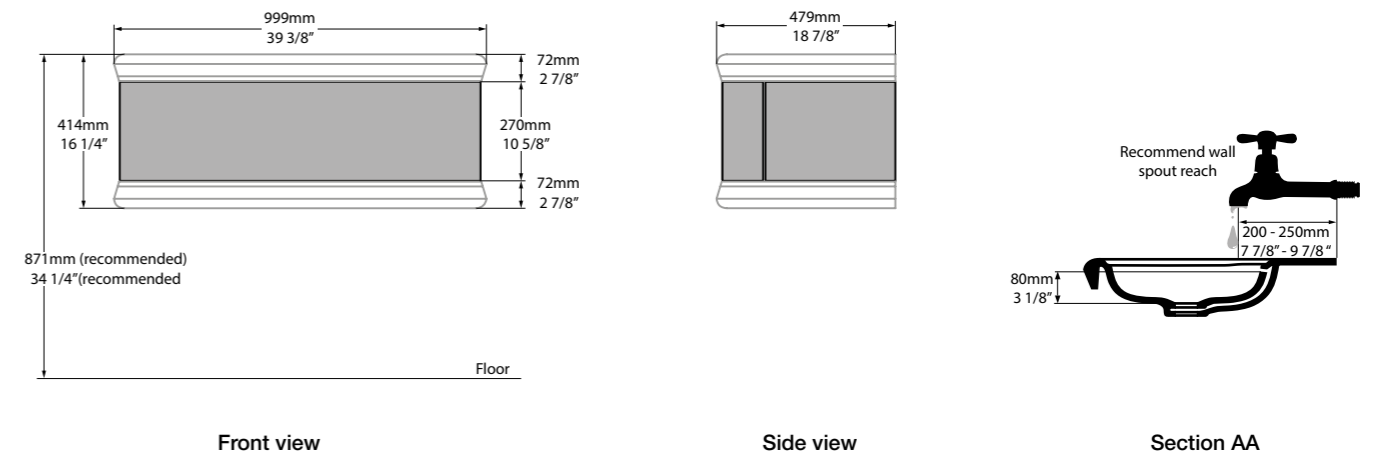

Tap holes can be drilled by installer
 Armaturenlöcher können leicht vom Installateur gebohrt werden
 Les trous de robinetterie peuvent être percés par l'installateur
 Pueden ser perforados por el instalador
 I fori per rubinetti possono essere perforati dall'installatore

LARV-N-100-xx-IO
 LARV-1TH-100-xx-IO
 LARV-3TH-100-xx-IO

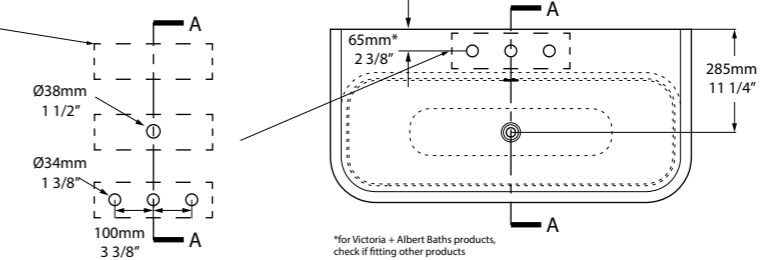

*for Victoria + Albert Baths products, check if fitting other products

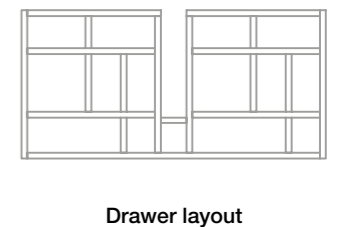

Drawer layout

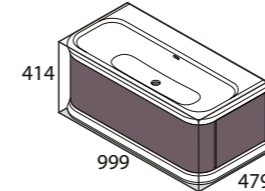

LARV-N-100-xx-IO
 LARV-1TH-100-xx-IO
 LARV-3TH-100-xx-IO
 41½Kg





LAV40-LH-xx LAV40-RH-xx

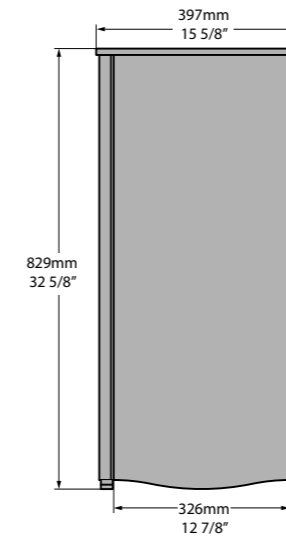

Front View

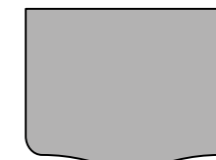

Top View

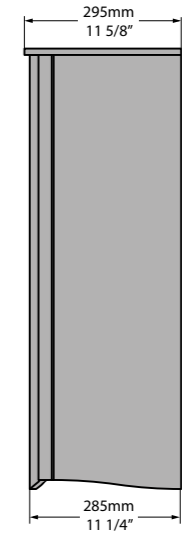

Side View

Un élégant meuble de rangement mural qui s'accorde parfaitement avec les meubles Lavello 114 ou Mandello 114.

- Dispose de deux étagères internes ajustables en merisier massif;
- La porte peut être montée pour une ouverture à droite ou à gauche;
- Disponible en Noir laqué, Anthracite ou Blanc Laqué.

Ein elegantes Schranksystem zur Wandmontage, das perfekt zu den Badmöbeln Lavello 114 und Mandello 114 passt.

- Mit zwei Regalen aus solidem Kirschholz;
- Die Tür kann mit Rechts- oder Linksanschlag montiert werden;
- Erhältlich in Schwarz Lack, Anthrazit oder Weiß Lack.

Un elegante armadietto a parete che si integra perfettamente con i mobiletti Lavello 114 o Mandello 114.

- È dotato di due ripiani interni regolabili in legno massello di ciliegio;
- La porta può essere installata per l'apertura a destra o sinistra;
- Disponibile in Nero Lucido, Antracite o Bianco Lucido.

Een elegante wandkast, de perfect aanvulling op de Lavello 114 of Mandello 114 meubels.

- Voorzien van twee verstelbare interne planken van massief kersenhout;
- Deur kan worden geïnstalleerd voor links of rechts openend;
- Verkrijgbaar in Zwart Glanzend, Antraciet, Wit Glanzend.

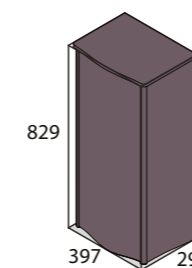

LAV40-LH-xx
LAV40-RH-xx
20Kg





Elégant meuble adapté à de nombreux intérieurs.

- Lavello 114 - Avec vasque en QUARRYCAST® et deux pieds;
- Lavello 114 Volo - Suspendu avec vasque en QUARRYCAST®;
- Possibilité de commander avec ou sans trou de robinetterie;
- Disponible en Blanc laqué, Anthracite ou Noir laqué.

Elegantes Badmöbel das mit vielen Einrichtungsstilen harmoniert.

- Lavello 114 mit QUARRYCAST® Becken und 2 Füße;
- Lavello 114 Volo zur Wandmontage mit QUARRYCAST® Becken;
- Optional mit oder ohne Armaturenlöcher;
- Erhältlich in Weiß Lack, Anthrazit und Schwarz Lack.

Elegante tavolo da toeletta adatto per una varietà di interni.

- Lavello 114 con lavabo in QUARRYCAST® e due gambe;
- Lavello 114 Volo montato a muro, con lavabo in QUARRYCAST®;
- Opzione per ordinare con o senza fori di rubinetto;
- Disponibile in Nero Lucido, Antracite o Bianco Lucido.

Elegant badmeubel geschikt voor een reeks van interieurs.

- Lavello 114 met een QUARRYCAST® wastafel, met twee poten;
- Lavello 114 Volo - wandmontage, met een QUARRYCAST® wastafel;
- Optioneel te bestellen met of zonder kraangaten;
- Verkrijgbaar in Zwart Glanzend, Antraciet en Wit Glanzend.



LAV-N-114-xx-IO LAV-1TH-114-xx-IO LAV-3TH-114-xx-IO

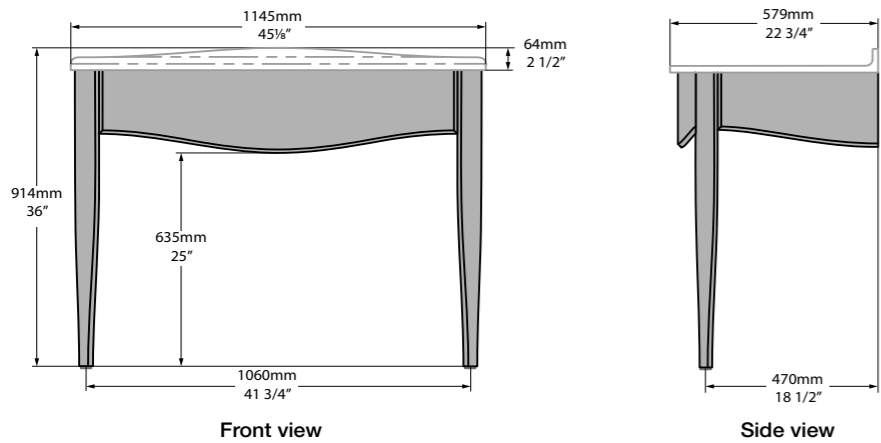

Tap holes can be drilled by installer
 Armaturenlöcher können leicht vom Installateur gebohrt werden
 Les trous de robinetterie peuvent être percés par l'installateur
 Pueden ser perforados por el instalador
 I fori per rubinetti possono essere perforati dall'installatore

LAV-N-114-xx-IO
 LAV-1TH-114-xx-IO
 LAV-3TH-114-xx-IO

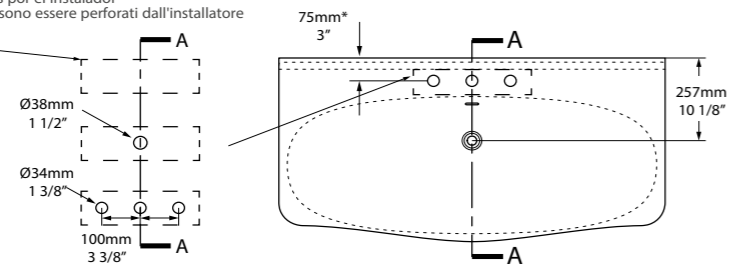

CE UPC Massachusetts Code cUPC listing by IAPMO

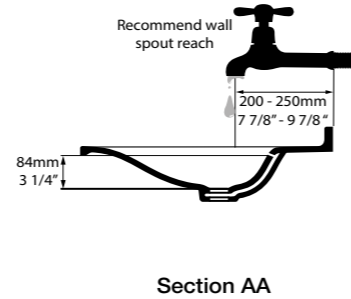

LAVV-N-114-xx-IO LAVV-1TH-114-xx-IO LAVV-3TH-114-xx-IO

CE UPC Massachusetts Code cUPC listing by IAPMO

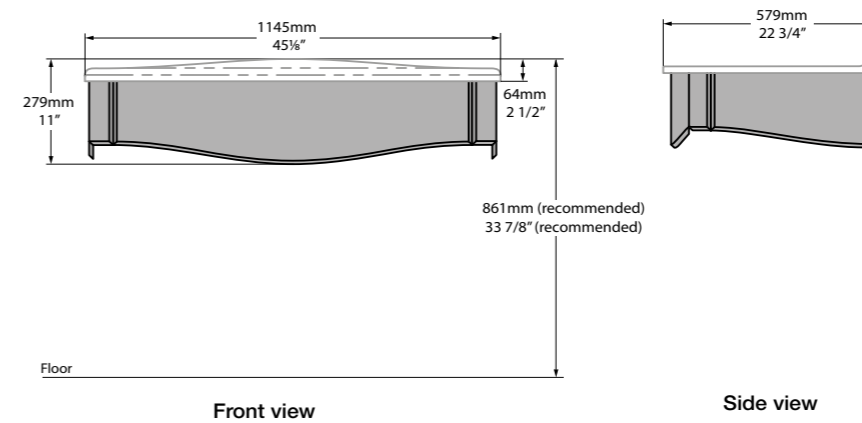

Tap holes can be drilled by installer
 Armaturenlöcher können leicht vom Installateur gebohrt werden
 Les trous de robinetterie peuvent être percés par l'installateur
 Pueden ser perforados por el instalador
 I fori per rubinetti possono essere perforati dall'installatore

LAVV-N-114-xx-IO
 LAVV-1TH-114-xx-IO
 LAVV-3TH-114-xx-IO

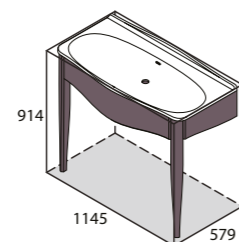
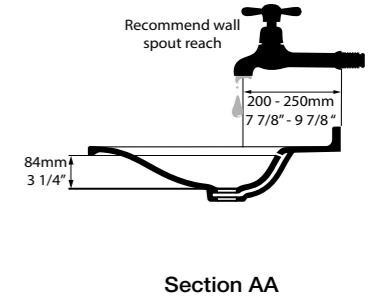
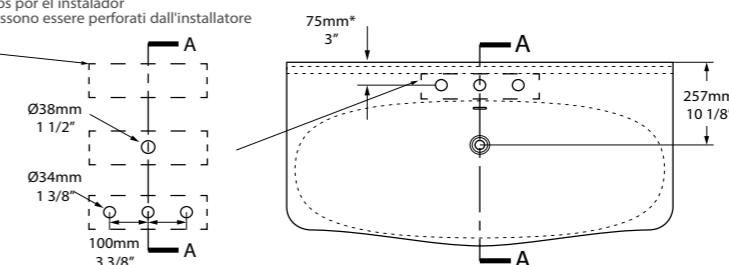

LAV-N-114-xx-IO
 LAV-1TH-114-xx-IO
 LAV-3TH-114-xx-IO
 25 1/2 Kg

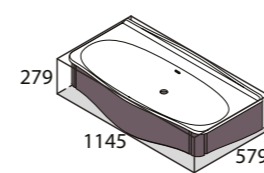

LAVV-N-114-xx-IO
 LAVV-1TH-114-xx-IO
 LAVV-3TH-114-xx-IO
 24 1/2 Kg





Elégant meuble adapté à de nombreux intérieurs.

- Lavello 114 Glass - Meuble suspendu avec deux pieds, surmonté d'un plateau de verre trempé adapté à toutes les vasques Victoria + Albert (non inclus);
- Lavello 114 Volo Glass - Meuble suspendu surmonté d'un plateau de verre trempé adapté à toutes les vasques Victoria + Albert (non inclus);
- Pré-percé pour kit de vidage, avec possibilité de commander avec ou sans trou de robinetterie;
- Disponible en Blanc Laqué, Anthracite ou Noir Laqué.

Elegantes Badmöbel das mit vielen Einrichtungsstilen harmoniert.

- Lavello 114 Glass, Badmöbel mit Auflage aus gehärtetem Glas und 2 Füße für alle Victoria + Albert Aufsatzbecken (nicht inklusive);
- Lavello 114 Volo Glass. Badmöbel zur Wandmontage mit Aufsatz aus gehärtetem Glas für alle Victoria + Albert Becken (nicht inklusive);
- Mit Vorbohrung für die Abflussrohre. Optional mit oder ohne Armaturenlöcher;
- Erhältlich in Weiß Lack, Anthrazit und Schwarz Lack.

Elegante tavolo da toeletta adatto per una varietà di interni.

- Lavello 114 Glass con due gambe e top in vetro durevole per tutti i lavabi Victoria + Albert (non incluso).
- Lavello 114 Volo Glass tavolo da toeletta montato a muro con top in vetro durevole per tutti i lavabi di Victoria + Albert (non incluso).
- Forato per kit di scarico, con la possibilità di averlo con o senza fori per il rubinetto;
- Disponibile in Nero Lucido, Antracite o Bianco Lucido.

Elegant badmeubel geschikt voor een reeks van interieurs.

- Lavello 114 Glass, badmeubel met 2 poten en een geharde glas top voor alle Victoria + Albert wasbakken (niet inbegrepen);
- Lavello 114 Volo Glass - badmeubel voor wandmontage met geharde glas top voor alle Victoria + Albert wasbakken (niet inbegrepen);
- Voorgeboord voor afvoer. Optioneel te bestellen met of zonder kraangaten;
- Verkrijgbaar in Zwart Glanzend, Antraciet en Wit Glanzend.



Lavello 114 Glass

LAVG-N-114-xx LAVG-1TH-114-xx

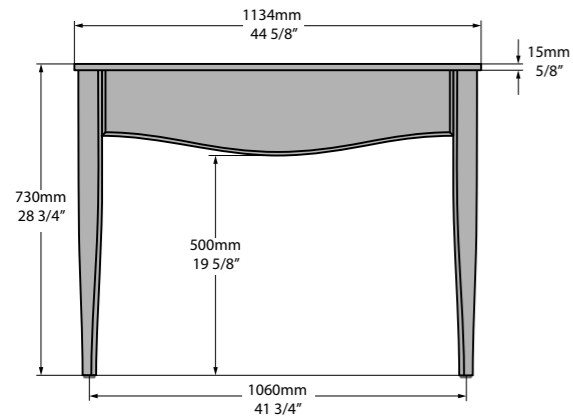

Front View

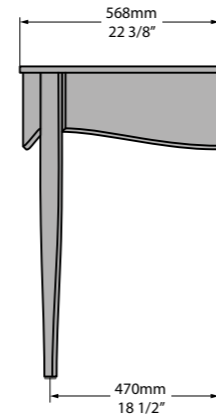

Side View

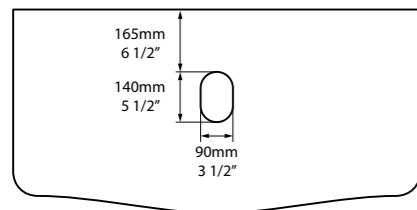

LAVG-N-114-xx

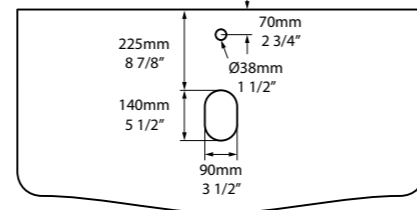

LAVG-1TH-114-xx

LAVVG-N-114-xx LAVVG-1TH-114-xx

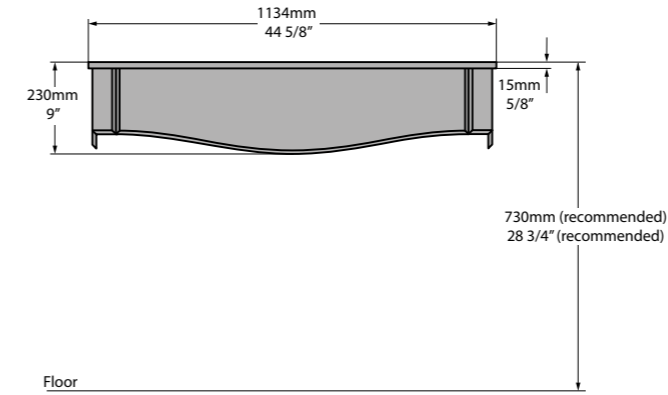

Front View

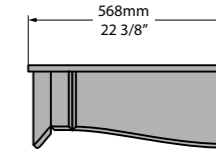

Side View

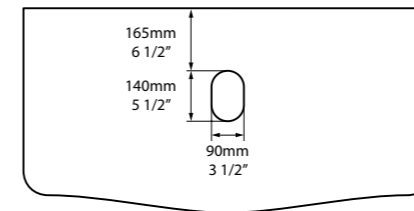

LAVVG-N-114-xx

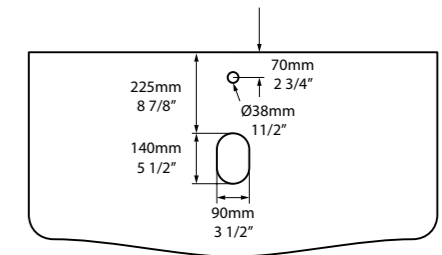

LAVVG-1TH-114-xx

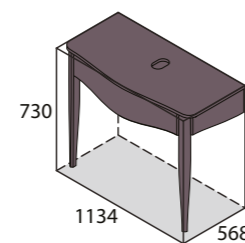

LAVG-N-114-xx
LAVG-1TH-114-xx
33Kg

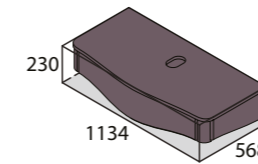

LAVVG-N-114-xx
LAVVG-1TH-114-xx
32Kg





Tiroir "push-to-open" (ouverture par simple pression) en merisier massif, avec un généreux espace de rangement et des séparateurs amovibles.

- Mandello 114 - Avec vasque en QUARRYCAST® et deux pieds;
- Mandello 114 Volo - Suspendu, avec vasque en QUARRYCAST®;
- Possibilité de commander avec ou sans trou de robinetterie;
- Disponible en Blanc Laqué, Anthracite et Noir Laqué.

Mit push-to-open Schublade aus solidem Kirschholz, mit viel Stauraum und entfernbaren Abtrennern.

- Mandello 114 mit QUARRYCAST® Becken und 2 Füßen;
- Mandello 114 Volo zur Wandmontage mit QUARRYCAST® Becken;
- Optional mit oder ohne Armaturenlöcher;
- Erhältlich in Weiß Lack, Anthrazit und Schwarz Lack.

Caratterizzato da un cassetto a spinta in legno di ciliegio con spazio generoso e divisori rimovibili.

- Mandello 114 con lavabo in QUARRYCAST®, con due gambe;
- Mandello 114 Volo montato a muro, con lavabo in QUARRYCAST®;
- Opzione per ordinare con o senza fori di rubinetto;
- Disponibile in Nero Lucido, Antracite o Bianco Lucido.

Voorzien van een push-to-open massief kersenhouten lade met royale opbergruimte en uitneembare verdelers.

- Mandello 114 met een QUARRYCAST® wastafel, met twee poten;
- Mandello 114 Volo - wandgemonteerd, met een QUARRYCAST® wastafel;
- Optioneel te bestellen met of zonder kraangaten;
- Verkrijgbaar in Zwart Glanzend, Antraciet en Wit Glanzend.



MAN-N-114-xx-IO MAN-1TH-114-xx-IO MAN-3TH-114-xx-IO

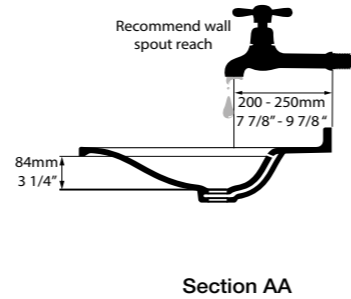
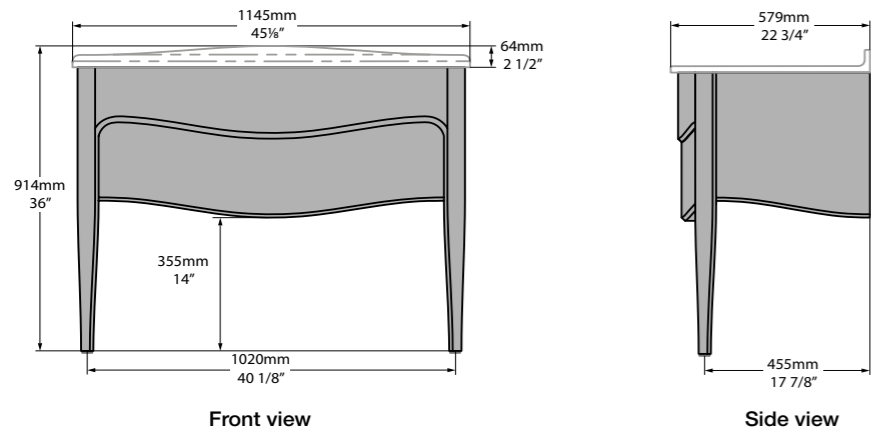

Tap holes can be drilled by installer
 Armaturenlöcher können leicht vom Installateur gebohrt werden
 Les trous de robinetterie peuvent être percés par l'installateur
 Pueden ser perforados por el instalador
 I fori per rubinetti possono essere perforati dall'installatore

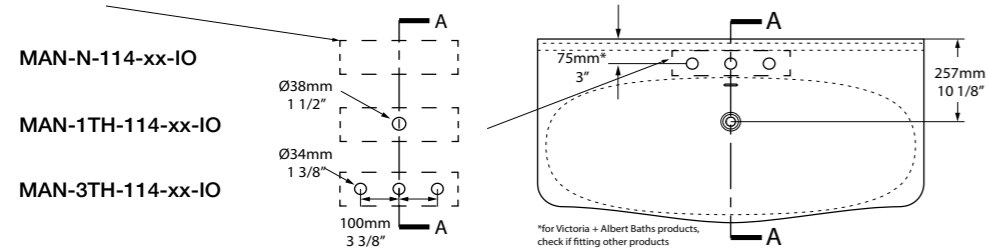

MANV-N-114-xx-IO MANV-1TH-114-xx-IO MANV-3TH-114-xx-IO

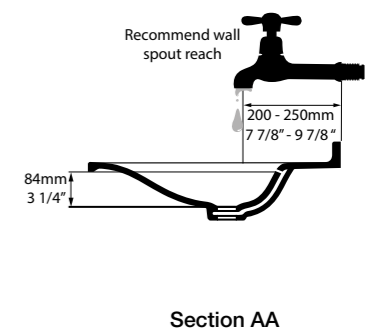
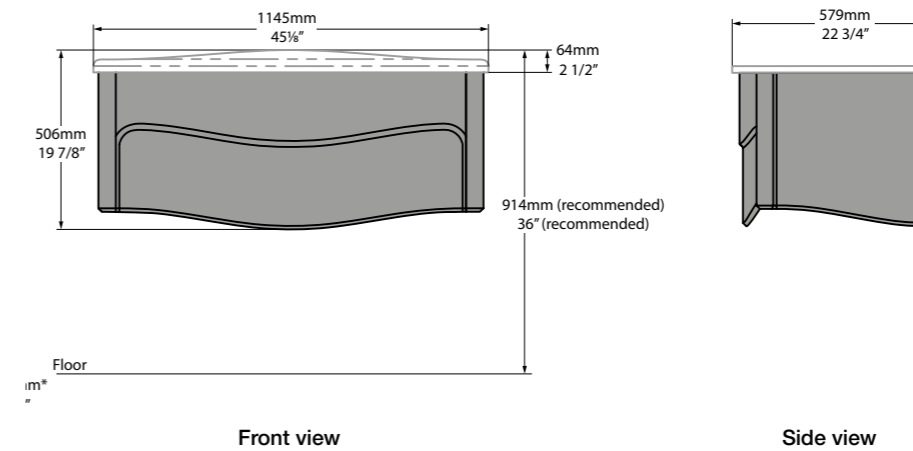

Tap holes can be drilled by installer
 Armaturenlöcher können leicht vom Installateur gebohrt werden
 Les trous de robinetterie peuvent être percés par l'installateur
 Pueden ser perforados por el instalador
 I fori per rubinetti possono essere perforati dall'installatore

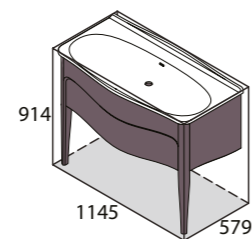
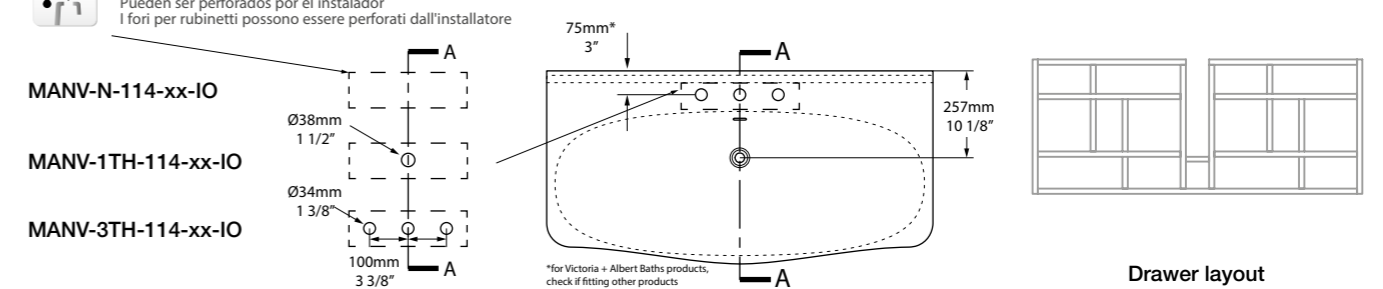

MAN-N-114-xx-IO
 MAN-1TH-114-xx-IO
 MAN-3TH-114-xx-IO
 50 1/2 Kg

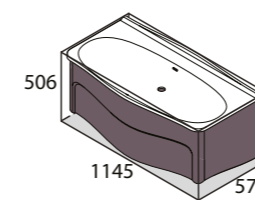

MANV-N-114-xx-IO
 MANV-1TH-114-xx-IO
 MANV-3TH-114-xx-IO
 49 1/2 Kg

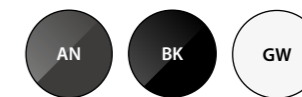

Mandello 114 Volo Glass



MANVG-N-114-xx MANVG-1TH-114-xx

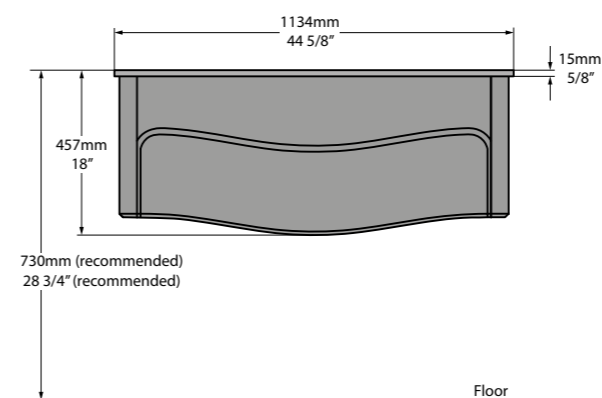

Front View

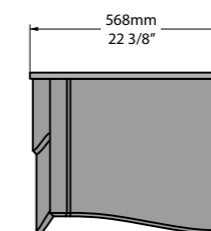

Side View

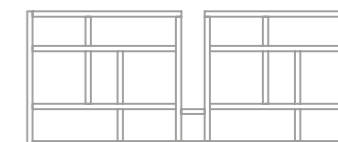

Drawer layout

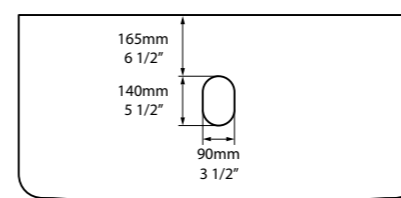

MANVG-N-114-xx

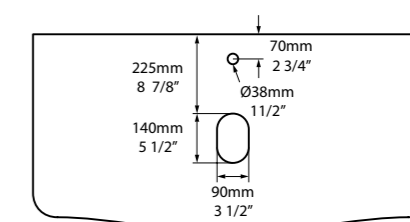

MANVG-1TH-114-xx

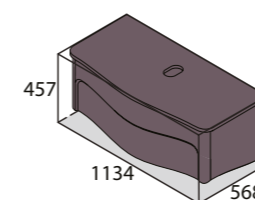

MANVG-N-114-xx-IO
MANVG-1TH-114-xx-IO
57Kg

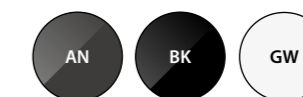

Tiroir "push-to-open" (ouverture par simple pression) en merisier massif, avec un généreux espace de rangement et des séparateurs amovibles.

- Meuble suspendu, surmonté d'un plateau de verre trempé adapté à toutes les vasques Victoria + Albert (non inclus);
- Pré-percé pour kit de vidage, avec possibilité de commander avec ou sans trou de robinetterie;
- Disponible en Blanc Laqué, Anthracite et Noir Laqué.

Mit push-to-open Schublade aus solidem Kirschholz, mit viel Stauraum und entfernbaren Abtrennern.

- Wandmontiertes Badmöbel mit Auflage aus gehärtetem Glas für alle Victoria + Albert Aufsatzbecken (nicht inklusive);
- Mit Vorbohrung für die Abflussrohre. Optional mit oder ohne Armaturenlöcher;
- Erhältlich in Weiß Lack, Anthrazit und Schwarz Lack.

Caratterizzato da un cassetto a spinta in legno di ciliegio con spazio generoso e divisori rimovibili.

- Mobiletto montato a parete con piano in vetro temperato per tutti i lavabi di Victoria + Albert a vassello (non incluso);
- Forato per kit di scarico, con la possibilità di averlo con o senza fori per il rubinetto;
- Disponibile in Nero Lucido, Antracite o Bianco Lucido.

Voorzien van een push-to-open massief kersenhouten lade met royale opberg ruimte en uitneembare verdelers.

- Badmeubel voor wandmontage met twee poten en een top van gehard glas voor alle Victoria + Albert wasbakken (niet inbegrepen);
- Voorgeboord voor afvoer. Optioneel te bestellen met of zonder kraangaten;
- Verkrijgbaar in Zwart Glanzend, Antraciet en Wit Glanzend.

Stiletto 110 Glass



STL-N-110-BK STL-1TH-110-BK

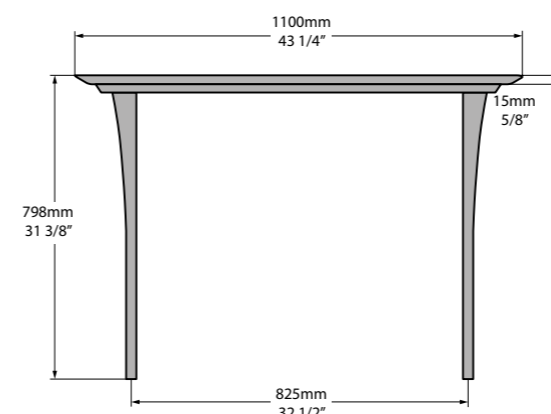

Front View

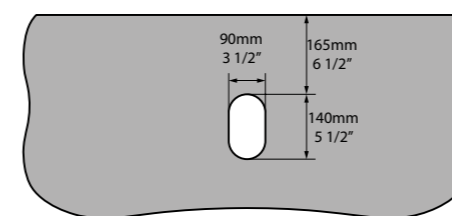

STL-N-110-xx

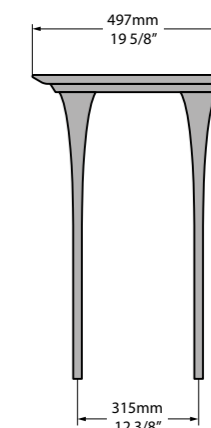

Side View

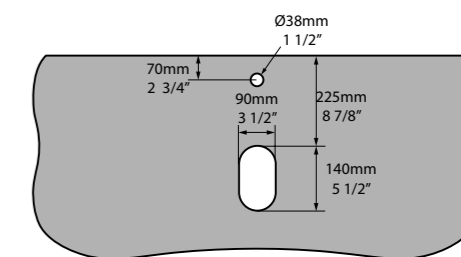

STL-1TH-110-xx



Console contemporaine imaginée par Brigid Stevens.

- Plan de vasque surmonté d'un plateau en verre trempé adapté à toutes les vasques Victoria + Albert.
- Perforation pour kit de vidage, avec ou sans trou de robinetterie (en option à la commande);
- Pieds en alliage d'aluminium ajustables pour un positionnement au sol parfait.

Moderne Badmöbel entworfen von Brigid Stevens.

- Möbel mit Auflage aus gehärtetem Glas, passend für alle Victoria + Albert Aufsatzbecken.
- Die Abflussöffnung ist vorgebohrt, die Löcher für die Armaturen auf Wunsch;
- In Höhe verstellbaren Füßen aus Aluminiumguss für einen perfekten Stand.

Contemporaneo tavolo da toeletta progettato da Brigid Stevens.

- Top in vetro durevole adatto a tutti i lavabi di Victoria + Albert.
- Forato per kit di scarico, con la possibilità di averlo con o senza fori per il rubinetto;
- Gambe in alluminio con piedini regolabili per livellamento perfetto.

Modern badmeubel ontworpen door Brigid Stevens.

- Gehard glazen top, geschikt voor alle Victoria + Albert wasbakken.
- Voorgeboord afvoergat, met opties om met of zonder kraangaten te bestellen;
- Gegoten aluminium poten met in hoogte verstelbare poten voor een perfecte stabiliteit.

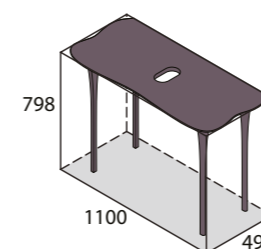

STL-N-110-xx
STL-1TH-110-xx
30Kg