

victoria ⊕ albert®

volcanic limestone baths



BATHS | BASINS | FURNITURE | BRASSWARE | ACCESSORIES



Baths

- Amalfi..... 14
- Amiata..... 18
- Barcelona..... 22
- NEW** Barcelona 2..... 26
- NEW** Barcelona 3..... 28
- Cabrits..... 30
- Cheshire..... 34
- Drayton..... 38
- Edge..... 42
- Eldon..... 46
- Elwick..... 50
- Hampshire..... 54
- ionian..... 58
- ios..... 62
- Marlborough..... 66
- Monaco..... 70
- Mozzano..... 74
- NEW** Mozzano 2..... 78
- Napoli..... 80
- Pembroke..... 84
- Pescadero..... 88
- Radford..... 92
- Ravello..... 96
- Richmond..... 100
- Roxburgh..... 104
- Shropshire..... 108
- Terrassa..... 112
- Toulouse..... 116
- Trivento..... 120
- Vetralla..... 124
- Vetralla 2..... 128
- Warndon..... 130
- Wessex..... 134
- Worcester..... 138
- York..... 142

Basins

- Amalfi 55..... 148
- Amiata 60..... 150
- Barcelona 48..... 152
- Barcelona 55..... 154
- Barcelona 64..... 156
- Cabrits 55..... 158
- Drayton 40..... 160
- Edge 45..... 162
- ios 54..... 164
- ios 80..... 166
- Maru 42..... 168
- Napoli 57..... 170
- Radford 51..... 172
- Ravello 60..... 174

Recessed Basins

- NEW** Kaali 46..... 178
- Lario 100 Solo..... 180
- Mandello 114 Solo..... 182
- Pembroke 52..... 184
- Rossendale 91..... 186
- NEW** Rossendale 107..... 188
- Rossendale 122..... 190

Washstands

- NEW** Candella 100..... 194
- NEW** Candella 114..... 196
- NEW** Metallo 100..... 198
- NEW** Metallo 114..... 200
- NEW** Metallo 61 Quartz..... 202
- NEW** Metallo 113 Quartz..... 204

Furniture

- Bosa 112 Glass..... 208
- Lario 100..... 210
- Lavello 40 Armadio..... 214
- Lavello 114..... 216
- Lavello 114 Glass..... 220
- Mandello 114..... 224
- Mandello 114 Volo Glass..... 228
- Stiletto 110 Glass..... 230

Mirrors

- NEW** Anatolia 55..... 234
- NEW** Anatolia 56..... 236
- Loano 97..... 238

Taps & Showers

- NEW** Hub 01..... 243
- Florin..... 244
- NEW** Soriano..... 254
- Staffordshire..... 264
- Tube..... 276

Waste Kits

- Basin Wastes..... 292
- Basin Bottle Traps..... 298
- Bath Wastes..... 300

Accessories

- Tombolo..... 310
- Backrests..... 312
- Headrests..... 314
- Handles..... 315

- World showcase..... 316
- Showrooms..... 332
- Next steps..... 336

 **FR** Sans trou de trop-plein.
DE Ohne Überlauf.
IT Senza foro per troppo pieno.
NL Zonder overloopgat.

 **FR** Avec trou de trop-plein.
DE Mit Überlauf.
IT Con foro per troppo pieno.
NL Met overloopgat.

 rich in
Volcanic
Limestone™

A lifetime of luxury bathing



* Garantie limitée seulement aux produits en QUARRYCAST® blancs; excluant la finition de peinture extérieure, les robinetteries, les kits de vidages et la finition des pieds. Cela n'affecte pas les droits des consommateurs établis.

* Die Garantie erstreckt sich nur auf weiße QUARRYCAST® Produkte, ausgenommen sind Farbfinishes, Armaturen, Ablaufsätze und Beschichtungen von Füßen. Ihr gesetzlicher Anspruch bleibt davon unberührt.

* Garanzia limitata ai soli prodotti QUARRYCAST® bianchi; escluse vernici, rubinetteria, kit di scarico & placcatura dei piedi. Ciò non pregiudica i diritti legali.

* Garantie beperkt tot witte QUARRYCAST® producten; exclusief kleuropties, kraanwerk, afvoeren en metaalafwerking van poten. Dit heeft geen invloed op uw wettelijke rechten.

Une vie consacrée aux salles de bains de luxe

Victoria + Albert Baths est né d'une passion pour les salles de bains de luxe.

La vision était simple : créer des pièces design qui établissent la norme pour le style, l'innovation et la performance. Des baignoires, vasques, robinets, mobiliers et accessoires qui offrent une expérience supérieure du bain.

Cette année, nous étoffons la gamme avec une nouvelle catégorie de lavabos qui vient compléter nos collections existantes de baignoires, vasques et robinetteries. Le résultat est une gamme complète de produits qui donne aux salles de bains de luxe une nouvelle dimension.

Avec deux décennies d'expérience en matière de fabrication, renforcées par une garantie de 25 ans*, choisir Victoria + Albert c'est bien plus qu'un simple achat, c'est un investissement pour la vie.

Luxuriös Baden – ein Leben lang

Victoria + Albert Baths wurde aus Leidenschaft zu luxuriösem Baden geboren.

Die Vision war klar: Designprodukte kreieren, die den Standard für Stil, Innovation und Leistung definieren. Badewannen, Waschbecken, Armaturen, Möbel und Accessoires, die ein einzigartiges Baderlebnis bieten.

In diesem Jahr haben wir unser Produktportfolio aus Wannen, Becken und Armaturen um eine neue Kategorie erweitert. Das Ergebnis ist eine komplette Serie von Badezimmerprodukten, die das Konzept von luxuriösem Baden auf ein neues Niveau heben.

Mit der beruhigenden 25-jährigen Garantie* ist eine Entscheidung für Victoria + Albert mehr als ein Kauf: sie ist eine Investition fürs Leben.

Una vita di bagni di lusso

Victoria + Albert Baths è nata dalla passione per il bagno di lusso.

La visione era semplice: creare pezzi di design che stabilissero lo standard per stile, innovazione e prestazioni. Vasche, lavabi, rubinetteria, mobili e accessori che offrono un'esperienza di bagno superiore.

Quest'anno espaneremo ulteriormente la gamma con una nuova categoria di lavabi e aggiungeremo nuovi modelli alle nostre collezioni di vasche, lavabi e rubinetteria esistenti. Il risultato è una gamma completa di prodotti per il bagno che elevano il concetto di bagno di lusso a un nuovo livello.

Con la tranquillità di una garanzia nazionale di 25 anni*, la scelta di Victoria + Albert è più di un acquisto, è un investimento per la vita.

Een leven lang van luxe baden

Victoria + Albert Baths werd geboren uit een passie voor luxe baden.

De visie was simpel: creer ontwerpen die een toon zetten qua voor stijl, innovatie en prestaties. Baden, wasbakken, kranen, meubels en accessoires die een superieure badervaring bieden.

Dit jaar breiden we het assortiment uit met een nieuwe categorie wastafels en voegen we deze toe aan onze bestaande bad-, wastafel- en kranen-collecties. Het resultaat is een compleet assortiment badkamerproducten die het concept van luxe badkamers naar een nieuw niveau tillen.

Met de gemoedsrust van een 25-jaar consumenten garantie*, is het kiezen voor Victoria + Albert meer dan een aankoop, het is een investering voor het leven.



A passion for detail



La passion du détail

Chez Victoria + Albert, notre souci du détail fait notre fierté : de notre savoir-faire à nos services clients dédiés, en passant par nos matériaux de haute qualité qui constituent chacun de nos produits.

Nous disposons d'un contrôle total du processus de fabrication, du début jusqu'à la fin. Chaque baignoire et chaque vasque est finie à la main et inspectée au sein de nos usines près de Cape Town en Afrique du Sud. L'investissement pour assurer un haut niveau de stock nous permet d'expédier les commandes depuis l'un de nos centres de distribution en quelques jours.

Notre souci du moindre détail est l'une des raisons pour laquelle Victoria + Albert a été sélectionné dans certains des plus luxueux hôtels et résidences du monde.

Leidenschaft für Details

Wir bei Victoria + Albert sind stolz auf unser Leidenschaft für Details: Von der erstklassigen Handwerkskunst und den edlen Materialien, die all unsere Produkte auszeichnen, bis hin zu unserem engagierten Kundenserviceteam.

Wir haben von Anfang bis Ende die volle Kontrolle über den Herstellungsprozess. Alle Wannen und Becken erhalten ein manuelles Finish und durchlaufen in unseren Fertigungsstätten in Kapstadt, Südafrika, eine strenge Endkontrolle.

Unsere Hingabe selbst für kleinste Details ist einer der vielen Gründe, warum Victoria + Albert Produkte für einige der weltweit luxuriösesten Hotels und Residenzen ausgewählt wurden.

Una passione per il dettaglio

A Victoria + Albert, siamo orgogliosi dell'attenzione per i dettagli; dall'artigianato, ai materiali di prima classe che danno vita ai nostri prodotti, al supporto del nostro team dedicato all'assistenza clienti.

Abbiamo il controllo totale del nostro processo di produzione dall'inizio alla fine; ogni vasca e lavabo è rifinito a mano e ispezionato nelle nostre fabbriche vicino a Città del Capo, in Sudafrica. In nostro investimento nel mantenere elevati livelli di inventario significa che possiamo spedire ordini da uno dei nostri centri di distribuzione globali in pochi giorni.

Il nostro impegno nel ricercare i dettagli più fini è uno dei tanti motivi per cui Victoria + Albert è protagonista in alcuni degli hotel e residence più lussuosi del mondo.

Een passie voor detail

Bij Victoria + Albert zijn we trots op aandacht voor detail; van het eerste klas vakmanschap en de materialen die in elk van onze producten worden gebruikt, tot de ondersteuning van ons toegewijde klantenserviceteam.

We hebben totale controle over ons productieproces van begin tot eind; elk bad en elke wastafel is met de hand afgewerkt en geïnspecteerd in onze fabrieken in de buurt van Kaapstad, Zuid-Afrika. Een investering in het handhaven van hoge voorraadniveaus betekent dat we binnen een paar dagen bestellingen van één van onze wereldwijde distributiecentra kunnen verzenden.

Onze toewijding aan de fijnere details is één van de vele redenen waarom Victoria + Albert is gespecificeerd in een aantal van de meest luxueuze hotels en residenties wereldwijd.

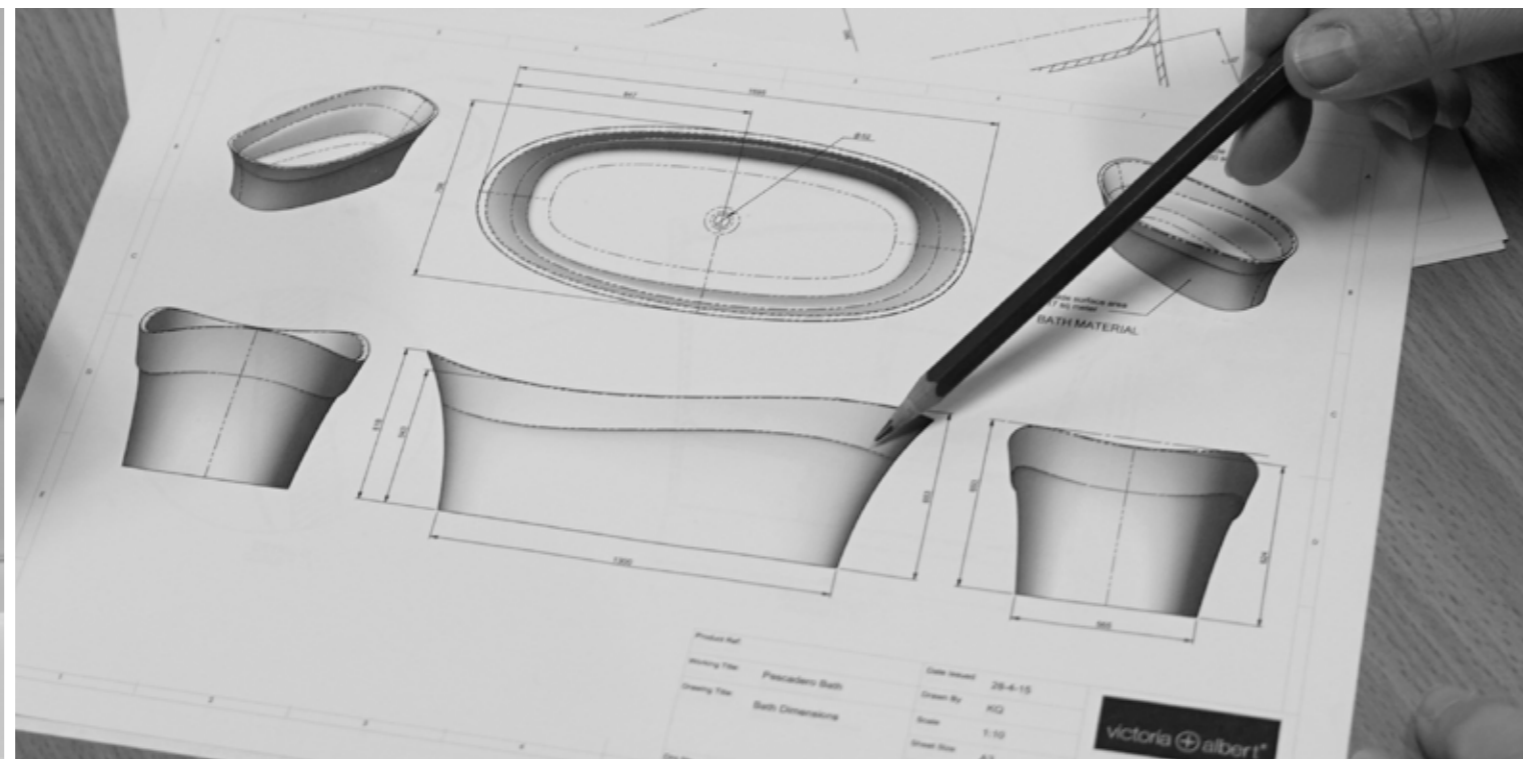

What is QUARRYCAST®?

Qu'est-ce que le QUARRYCAST®?

Le QUARRYCAST®, notre matériau exclusif, est constitué d'un mélange unique de Volcanic Limestone™ et de résines ultra-performantes.

Volcanic Limestone™ est le nom donné par Victoria + Albert à sa pierre blanche très spéciale, parfaite pour concevoir des baignoires et des vasques.

Sa création résulte de l'action des forces élémentaires associées au magma liquide sur la pierre à chaux douce et crayeuse qui l'entoure. L'immense chaleur et la pression du magma transforment la pierre environnante en un nouveau matériau composé de fibres incroyablement résistantes.

Nous mélangeons la Volcanic Limestone™ réduite en poudre à des résines de haute qualité afin de lier ces fibres en une matrice complexe en 3D. Le résultat fini est appelé QUARRYCAST® – un composite de premier ordre qui offre une solidité, une durabilité et une élégance incomparable.

Was ist QUARRYCAST®?

Unser eigens entwickeltes Material besteht aus einer einzigartigen Mischung aus Volcanic Limestone™ und hochwertigen Harzen. Volcanic Limestone™ ist Victoria + Alberts Bezeichnung für das spezielle weiße Gestein, das sich perfekt für die Herstellung von Wannen und Becken eignet. Es entstand dadurch, dass Urgewalten im Zusammenspiel mit flüssigem Magma auf das umliegende, weiche Kreidekalkgestein einwirkten. Die immense Hitze und der Druck des Magmas verwandelten das Gestein in ein neues Material, das unglaublich harte, innenliegende Verstrebungen besitzt.

Wir mischen den gemahlten Volcanic Limestone™ mit hochwertigen Harzen, um diese Verstrebungen in einem komplexen 3D Muster zu binden. Das fertige Produkt nennen wir QUARRYCAST® - ein erstklassiges Stein-Verbundmaterial von unübertroffener Stabilität, Langlebigkeit und Schönheit.

Cos'è QUARRYCAST®?

Il nostro materiale QUARRYCAST® appositamente sviluppato, è costituito da una miscela unica di pietra calcare Vulcanica Limestone e resine ad alte prestazioni.

Volcanic Limestone™ è il nome che Victoria + Albert utilizza per la speciale pietra bianca che è perfetta per la creazione di vasche e lavabi. Si forma quando le forze elementali associate al magma liquido agiscono sul limpido calcare calcareo. L'immenso calore e la pressione del magma trasformano la roccia vicina in un nuovo materiale costituito da fili incredibilmente duri.

Mescoliamo la roccia Vulcanica Limestone macinata con resine di alta qualità per legare questi fili in una matrice 3D complessa. Il risultato finale è QUARRYCAST® - un composito di pietra di livello mondiale che offre resistenza, durata e bellezza senza rivali.

Wat is QUARRYCAST®?

Ons speciaal ontwikkelde QUARRYCAST®-materiaal is gemaakt van een unieke mix van Volcanic Limestone™ en hoogwaardige harsen.

Volcanic Limestone™ is Victoria + Albert's naam voor de zeer speciale witte steen die perfect is voor het maken van baden en wasbakken. Het wordt gevormd wanneer de elementaire krachten geassocieerd met vloeibaar magma werken op het omringende zachte, kalkachtige kalksteen. De immense hitte en druk van het magma transformeert de naburige steen in een nieuw materiaal dat bestaat uit ongelooflijk harde strengen.

We mengen gemalen Volcanic Limestone™ met hoogwaardige harsen om deze strengen te binden tot een complexe 3D-matrix. Het resultaat is QUARRYCAST® - een composiet van wereldklasse, dat een ongeëvenaarde sterkte, duurzaamheid en schoonheid biedt.

What are the benefits of QUARRYCAST®?

Quels sont les avantages du QUARRYCAST®?

Was sind die Vorteile von QUARRYCAST®?

Quali sono i vantaggi di QUARRYCAST®?

Wat zijn de voordelen van QUARRYCAST®?



- **Facile à nettoyer:** résistant aux produits chimiques agressifs. La surface naturellement brillante est facile à nettoyer.
- **Leicht zu reinigen:** beständig gegen aggressive Reinigungsmittel. Die natürlich glänzende Oberfläche lässt sich leicht reinigen.
- **Facile da pulire:** resistente a sostanze chimiche detergenti abrasive. La superficie naturalmente lucida è facile da pulire.
- **Eenvoudig te reinigen:** bestand tegen agressieve chemicaliën. Het van nature glanzende oppervlak is eenvoudig schoon te vegen.



- **Chaud:** chaud au toucher avec des propriétés d'isolation performantes permettant de garder l'eau du bain chaude plus longtemps.
- **Warm:** angenehm zur Haut mit stark isolierenden Eigenschaften. Ihr Badewasser bleibt länger warm.
- **Caldo:** caldo al tatto con elevate proprietà isolanti, per mantenere più a lungo l'acqua del bagno più calda.
- **Warm:** het voelt warm aan en bezit hoge warmte isolerende eigenschappen, waardoor uw badwater langer warm blijft.



- **Résistant aux éraflures et aux tâches:** la surface naturellement blanche et brillante est incroyablement résistante aux teintures capillaires et aux huiles de bain.
- **Unempfindlich und Flecken abweisend:** die natürlich weiß glänzende Oberfläche ist unglaublich strapazierfähig und resistent gegen Haarfärbemittel und Badeöle.
- **Resistente ai graffi e alle macchie:** la superficie lucida, naturalmente bianca, è incredibilmente durevole e resistente alle tinture e agli oli da bagno.
- **Kras- en vlekbestendig:** het van nature witte, glanzende oppervlak is ongelooflijk duurzaam en bestand tegen haarkleurmiddelen en badoliën.



- **Robuste:** QUARRYCAST® est entièrement solide - deux fois plus robuste que l'acrylique sans risque de craquelure ni de flexion.
- **Stabil:** QUARRYCAST® ist ein massiver Werkstoff - mehr als doppelt so hart wie Acryl, kein Knarren oder Verbiegen.
- **Forte:** QUARRYCAST® è solido fino in fondo - più del doppio rispetto all'acrilico senza scricchiolii o flessioni.
- **Sterk:** QUARRYCAST® is helemaal solide - meer dan twee keer zo hard als acryl. Bovendien kraakt of buigt het niet.



- **Léger:** étonnamment léger, le poids moyen de nos baignoires est de 72kg.
- **Leichtgewicht:** unsere überraschend leichten Wannen wiegen im Durchschnitt nur 72kg.
- **Leggero:** sorprendentemente leggero, il peso medio delle nostre vasche è di soli 72kg.
- **Lichtgewicht:** verrassend lichtgewicht, het gemiddelde gewicht van onze baden is slechts 72kg.



- **Garanti:** garantie résidentielle de 25 ans, garantie commerciale de 8 ans*.
- **Garantie:** 25 Jahre garantie bei privater Nutzung, 8 Jahre garantie bei gewerblicher Nutzung*.
- **Garanzia:** residenziali 25 anni di garanzia, commerciale 8 anni di garanzia*.
- **Garantie:** 25 Jaar consumentengarantie, 8 jaar commerciële garantie*.

* Garantie limitée seulement aux produits en QUARRYCAST® blancs; excluant la finition de peinture extérieure, les robinetteries, les kits de vidages et la finition des pieds. Cela n'affecte pas les droits des consommateurs établis.

* Die Garantie erstreckt sich nur auf weiße QUARRYCAST® Produkte, ausgenommen sind Farbfinishes, Armaturen, Abflusätze und Beschichtungen von Füßen. Ihr gesetzlicher Anspruch bleibt davon unberührt.

* Garanzia limitata ai soli prodotti QUARRYCAST® bianchi; esclude vernici, rubinetteria, kit di scarico & placcatura dei piedi. Ciò non pregiudica i diritti legali.

* Garantie beperkt tot witte QUARRYCAST® producten; exclusief kleuropties, kraanwerk, afvoeren en metaalafwerking van poten. Dit heeft geen invloed op uw wettelijke rechten.

Soriano: a new collection

Soriano : une nouvelle collection

Nouveauté 2018 – Nous sommes fiers de présenter Soriano, une nouvelle gamme de robinets en Inox brossé conçue par des designers italiens Meneghello Paoletti Associati.

Le design s'inspire du Booléen, un type de variable en logique et en programmation informatique caractérisé par un code d'entrée binaire 0/1. L'ingéniosité de la collection Soriano vient de sa simplicité : le bec, le levier et la base de chaque pièce est définie par une forme. L'élégance pointue et épurée de la collection fait d'elle le choix idéal pour les salles de bains contemporaines.

Choisissez parmi une gamme complète de modèles en fonction de votre projet, incluant des robinets pour vasques, des mitigeurs pour baignoires et des applications encastrées pour douches.

Soriano: Eine neue Kollektion

Wir freuen uns, 2018 die Serie Soriano vorstellen zu dürfen, eine neue Armaturen-Vielfalt in gebürstetem Edelstahl, entwickelt von den italienischen Designern Meneghello Paoletti Associati.

Das Design ist inspiriert von der Boolean-Struktur. Boolean ist eine Programmiersprache, die durch 1 und 0 definiert wird. Das brillante an Soriano ist ihre Einfachheit. Wasserhahn, Hebel und Basis beziehen sich auf die gleiche Form. Die klare, präzise Eleganz dieser Kollektion macht sie zur perfekten Wahl für modernes Badezimmerdesign.

Wählen Sie aus einer großen Produktvielfalt - passend zu Ihrem individuellen Design: Wasserhähne, Wannen-Mischarmaturen und Unterputz-Duscharmaturen.

Soriano: una nuova collezione

Novità per il 2018, siamo lieti di presentare Soriano, una nuova gamma di rubinetteria in Acciaio Inossidabile spazzolato disegnata da designer italiani, Meneghello Paoletti Associati.

Il design è stato ispirato da Boolean, la logica di codifica definita da "1s" e "0s". Lo splendore di Soriano è la sua semplicità; il beccuccio, la leva e la base di ogni pezzo sono definiti da una forma. L'eleganza pulita e tagliente della collezione la rende la scelta perfetta per il design contemporaneo del bagno.

Scegli tra una gamma completa di pezzi adatti al tuo design, compresi rubinetti per lavabo, miscelatori per vasca e applicazioni per doccia nascoste.

Soriano: een nieuwe collectie

Dit jaar introduceren we Soriano, een nieuwe collectie van RVS kranen, ontworpen door Italiaanse ontwerpers, Meneghello Paoletti Associati.

Het ontwerp is geïnspireerd door Boolean, de codeerlogica gedefinieerd door "1s" en "0s". De kracht van Soriano ligt in zijn eenvoud; de uitloop, hendel en basis van elk stuk worden bepaald door één vorm. De zuivere, scherpe elegantie van de collectie maakt het de perfecte keuze voor een modern badkamerontwerp.

Kies voor uw ontwerp uit een volledig assortiment inclusief wastafelkranen, badmengkranen en douchetoepassingen.

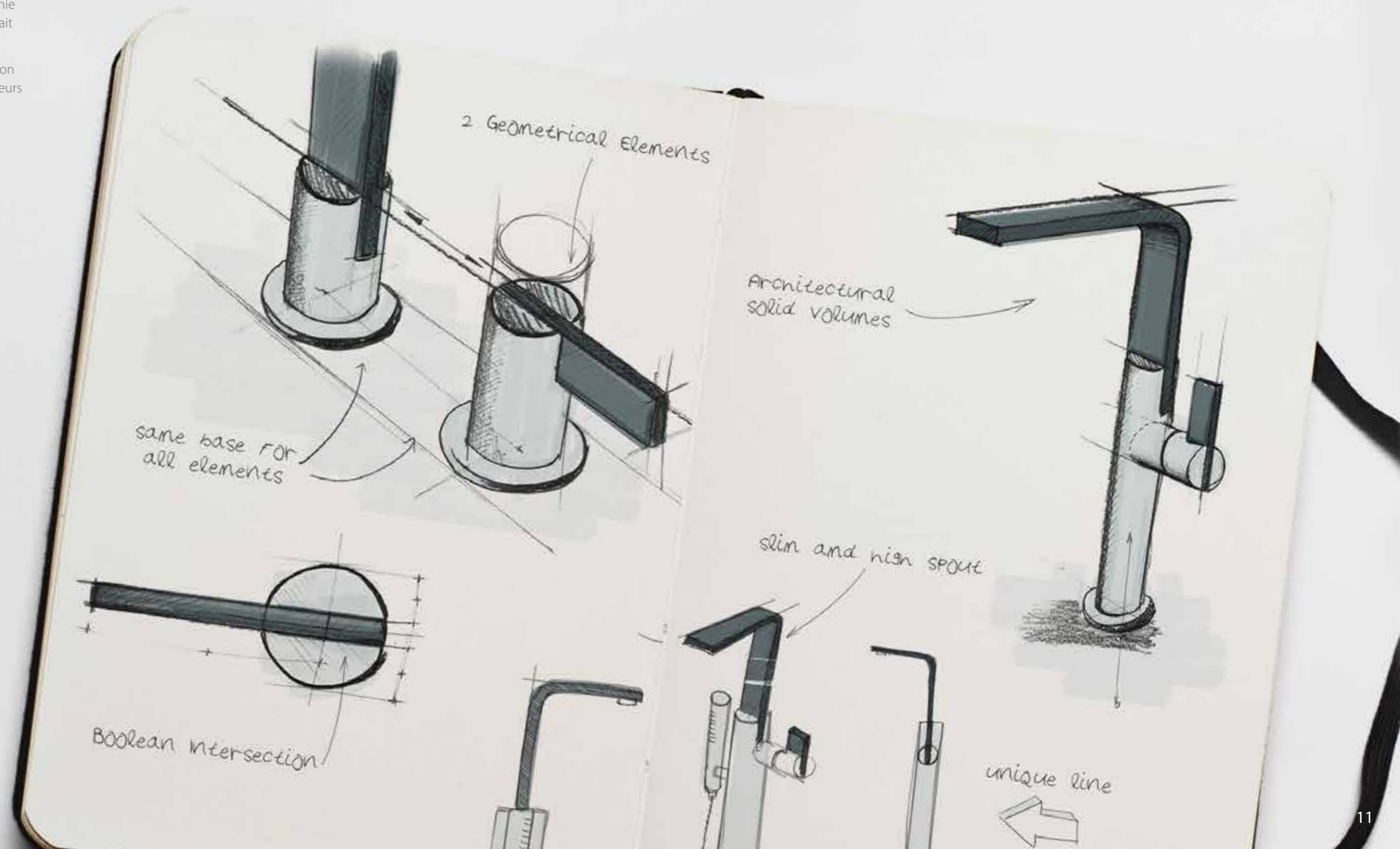

Une gamme primée de baignoires îlot qui convient à tous les styles et à toutes les tailles de salles de bains. De petites baignoires à la silhouette rectiligne à celles offrant des volumes plus généreux, il existe une forme et un style adaptés à chacun. Notre matériau QUARRYCAST® est unique et est un des leaders du marché depuis plus de vingt ans.

Eine preisgekrönte Reihe freistehender Wannen, die in Badezimmer unterschiedlichster Stilrichtungen und Größen passen. Von kompakteren Modellen bis hin zu großzügig bemessenen Rolltop Wannen finden Sie hier Formen und Designs für jeden Anspruch. Unser einmaliges QUARRYCAST® Verbundmaterial ist Marktführer seit über 20 Jahren.

Una gamma pluripremiata di vasche freestanding adatta a stanze da bagno di diversi stili e dimensioni. Da vasche da bagno compatte a rolltops, offriamo forme e stili per soddisfare ogni bisogno. Il nostro composito unico QUARRYCAST® è stato un leader di mercato da oltre vent'anni.

Een bekoonde reeks van vrijstaande baden, geschikt voor badkamers van alle stijlen en maten. Van modern compact tot ruime traditionele baden, er is een vorm en stijl die bij elke bader past. Ons unieke QUARRYCAST® composiet is al meer dan twintig jaar een marktleider.

AN Gris Anthracite. Anthrazit. Antracite. Antraciet.	BK Noir Brillant. Schwarz Lack. Nero Lucido. Zwart Glans.	GR Gris Clair. Hellgrau. Grigio Chiaro. Licht Grijs.	SW QUARRYCAST® Blanc. QUARRYCAST® Weiß. QUARRYCAST® Bianco. QUARRYCAST® Wit.
SG Gris Pierre. Steingrau. Grigio Pietra. Steen Grijs.	MW Blanc Mat. Mattweiß. Bianco Opaco. Wit Mat.	MB Noir Mat. Mattschwarz. Nero Opaco. Zwart Mat.	Qc rich in Volcanic Limestone™

Pieds / Füßen / Piedi / Poten

PC Chrome Poli. Chrom Poliert. Cromo Lucidato. Chroom Glanzend.	PB Laiton Poli. Messing Poliert. Ottone Lucidato. Messing Glanzend.	PN Nickel Poli. Nickel Poliert. Nickel Lucidato. Nickel Glanzend.	SW QUARRYCAST® Blanc. QUARRYCAST® Weiß. QUARRYCAST® Bianco. QUARRYCAST® Wit.
BN Nickel Brossé. Nickel Gebürstet. Nickel Spazzolato. Nickel Geborsteld.	AB Bronze Vieilli. Bronze Antik. Bronzo Invecchiato. Oud Brons.	WH Métal Blanc. Metall Weiß. Metallo Bianco. Wit Metalen.	Qc rich in Volcanic Limestone™

	Vetralla 1493 x 739 Page 124	Edge 1498 x 799 Page 42	ios 1511 x 802 Page 62	Wessex 1525 x 761 Page 134	Shropshire 1537 x 762 Page 108	Amalfi 1632 x 794 Page 14
Dual ended	✓	✓	✓			
Feet				✓	✓	
	Mozzano 1645 x 741 Page 74	Amiata 1645 x 800 Page 18	Trivento 1650 x 707 Page 120	Vetralla 2 1650 x 727 Page 128	Richmond 1675 x 745 Page 100	Mozzano 2 1682 x 762 Page 78
Dual ended		✓	✓	✓	✓	
Feet					✓	
	Drayton 1685 x 842 Page 38	Pescadero 1695 x 798 Page 88	Barcelona 2 1700 x 800 Page 26	ionian 1701 x 793 Page 58	Terrassa 1702 x 793 Page 112	Warndon 1702 x 801 Page 130
Dual ended		✓	✓	✓	✓	✓
Feet	✓					

Dual ended / Double assise / Doppelseitig / Doppia seduta / Dubbelzijdig.

Feet / Pieds / Füßen / Piedi / Poten.

	Roxburgh 1704 x 809 Page 104	Hampshire 1705 x 776 Page 54	York 1741 x 795 Page 142	Cabrits 1743 x 748 Page 30	Ravello 1743 x 753 Page 96	Cheshire 1744 x 798 Page 34
Dual ended			✓		✓	✓
Feet	✓	✓				✓
	Monaco 1744 x 806 Page 70	Eldon 1749 x 850 Page 46	Pembroke 1765 x 798 Page 84	Barcelona 1785 x 854 Page 22	Barcelona 3 1792 x 865 Page 28	Worcester 1797 x 780 Page 138
Dual ended	✓	✓	✓	✓	✓	✓
Feet						
	Toulouse 1808 x 800 Page 116	Napoli 1900 x 855 Page 80	Marlborough 1901 x 870 Page 66	Elwick 1902 x 910 Page 50	Radford 1902 x 910 Page 92	
Dual ended	✓		✓	✓	✓	
Feet					✓	

Amalfi

Ses courbes adoucies tombent élégamment sur le sol sans être encombrées par de la tuyauterie. Son dossier allongé vous permet de vous relaxer à tête reposée, ce qui est absolument essentiel lors de longues ablutions. Accompagnée par la vasque Amalfi 55 (page 148). Disponible en sept couleurs.

Weich konturierte Seiten bis zum Boden, Rohre des Ablaufes ordentlich versteckt und eine erweiterte Rückenlehne welche eine volle Unterstützung des Kopfes bietet; wesentlich für das lange luxuriöse Baden. Mit dem Amalfi 55 Waschbecken zu ergänzen (seite 148). Erhältlich in 7 Außenfarben.

Progettata con linee semplici, che allo stesso tempo rendono invisibile il sistema di scarico; un comodo schienale fornisce un estensivo supporto per la nuca, essenziale per godere una lunga e lussuosa vasca. Complementato dal lavabo Amalfi 55 (pagina 148). Disponibile in sette finiture di colore.

Zacht ronde zijden, een netjes afgewerkte overloop en een langere rugleuning bieden volledige ondersteuning van het hoofd; van essentieel belang voor diegene die van lang luxueus baden houdt. Aangevuld met de Amalfi 55 wasbak (pg 148). Verkrijgbaar in zeven kleurafwerkingen.

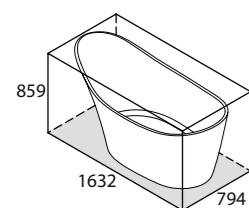

○ AML-N-SW-NO
 ■ AML-N-xx-NO
 68Kg

Collections connexes / Entsprechendes Zubehör / Collezioni correlate / Gerelateerde collecties



⊕ Tubo 14
Page 277

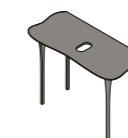

⊕ Stiletto 110 Glass
Page 230



⊕ Amalfi 55
Page 148



⊕ Tubo 16
Page 279

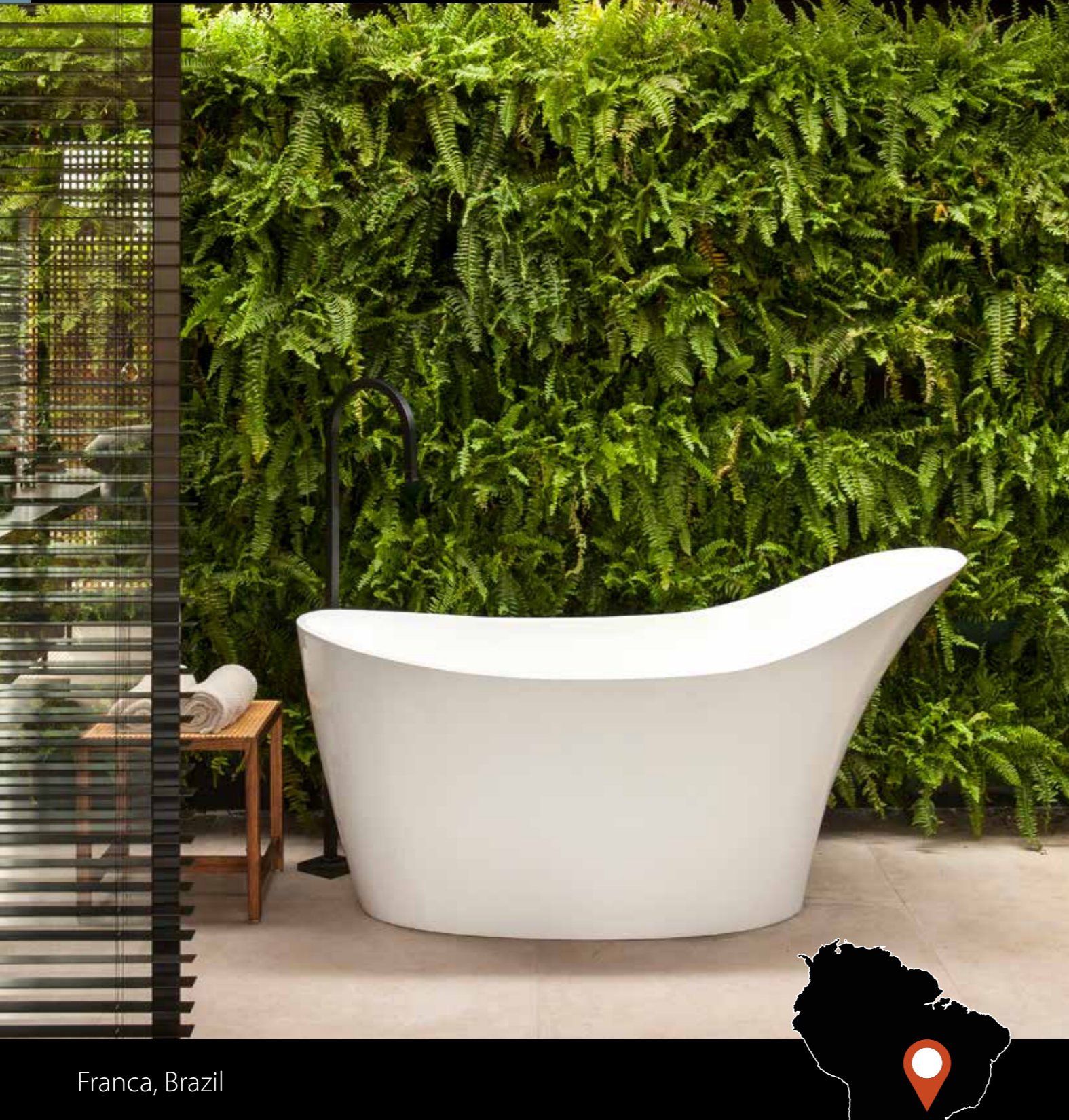

Franca, Brazil

Photography by: Felipe Araújo



○ AML-N-SW-NO  ↓ AML-N-xx-NO 

CE  Massachusetts Code
cUPC listing by IAPMO

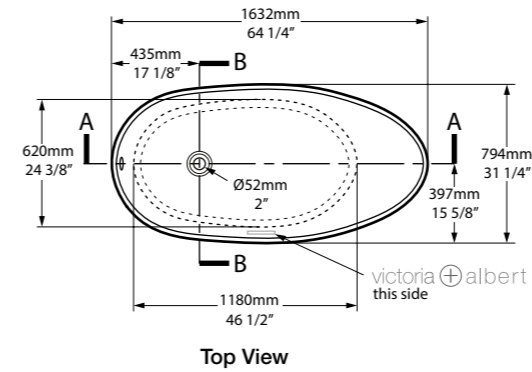

Top View

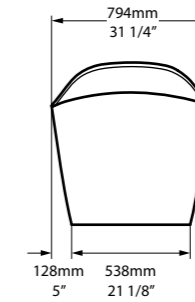

Front View

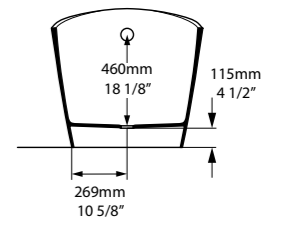

Section BB

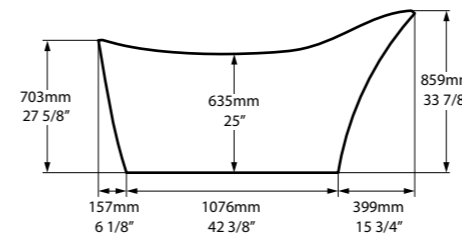

Side View

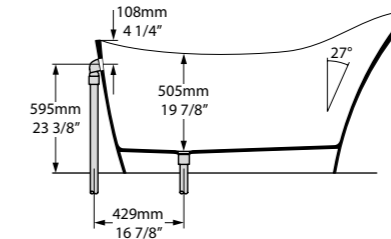

Section AA

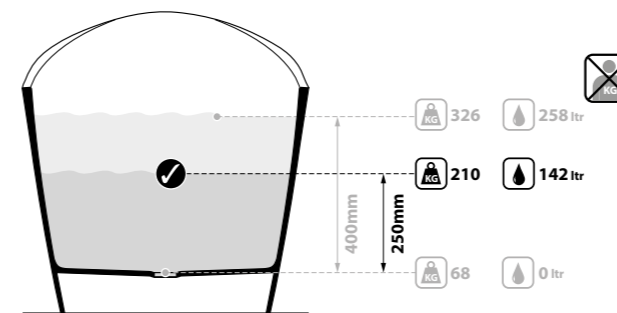

SW  rich in Volcanic Limestone  AN  BK  GR  MB  MW  SG



reddot award 2015
winner

La collection primée Amiata a été conçue par Meneghello Paoletti Associati. Avec ses courbes organiques et ses proportions élégantes, cette collection offre un style classique et un design ergonomique. Amiata s'intègre parfaitement dans les espaces classiques et modernes. A associer à la vasque Amiata 60 (page 150). Disponible en sept couleurs.

Die preisgekrönte Amiata Kollektion wurde von den italienischen Designern Meneghello Paoletti Associati entworfen. Die Serie ist gekennzeichnet durch harmonische Kurven und elegante Proportionen, sie verbindet klassischen Stil mit ergonomischen Formen. Amiata passt perfekt in traditionelle sowie in moderne Bäder. Zu kombinieren mit dem Amiata 60 Waschbecken (Seite 150). Erhältlich in 7 Außenfarben.

Amiata è stata concepita appositamente per Victoria + Albert dai designer Italiani, Meneghello Paoletti Associati, ed ha ricevuto un prestigioso Red Dot Design Award. Questa collezione, con le sue curve organiche e le proporzioni eleganti, offre uno stile classico ed ergonomico. Amiata funziona perfettamente in spazi sia tradizionali che moderni. Complementata dal lavabo Amiata 60 (pagina 150). Disponibile in sette finiture di colore.

De Amiata collectie, welke de prestigieuze Award heeft gewonnen, is ontworpen door Meneghello Paoletti Associati. Deze collectie, met zijn organische rondingen en elegante proporties, biedt klassieke stijl en ergonomie. Amiata past perfect in zowel landelijke als moderne badkamers. Aangevuld met de Amiata 60 wasbak (pg 150). Verkrijgbaar in zeven kleurafwerkingen.

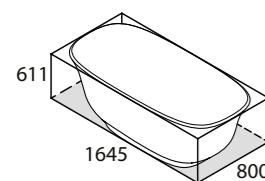

○ AMT-N-SW-NO
■ AMT-N-xx-NO
65Kg



Collections connexes / Entsprechendes Zubehör / Collezioni correlate / Gerelateerde collecties



Tubo 14
Page 277



Amiata 60
Page 150

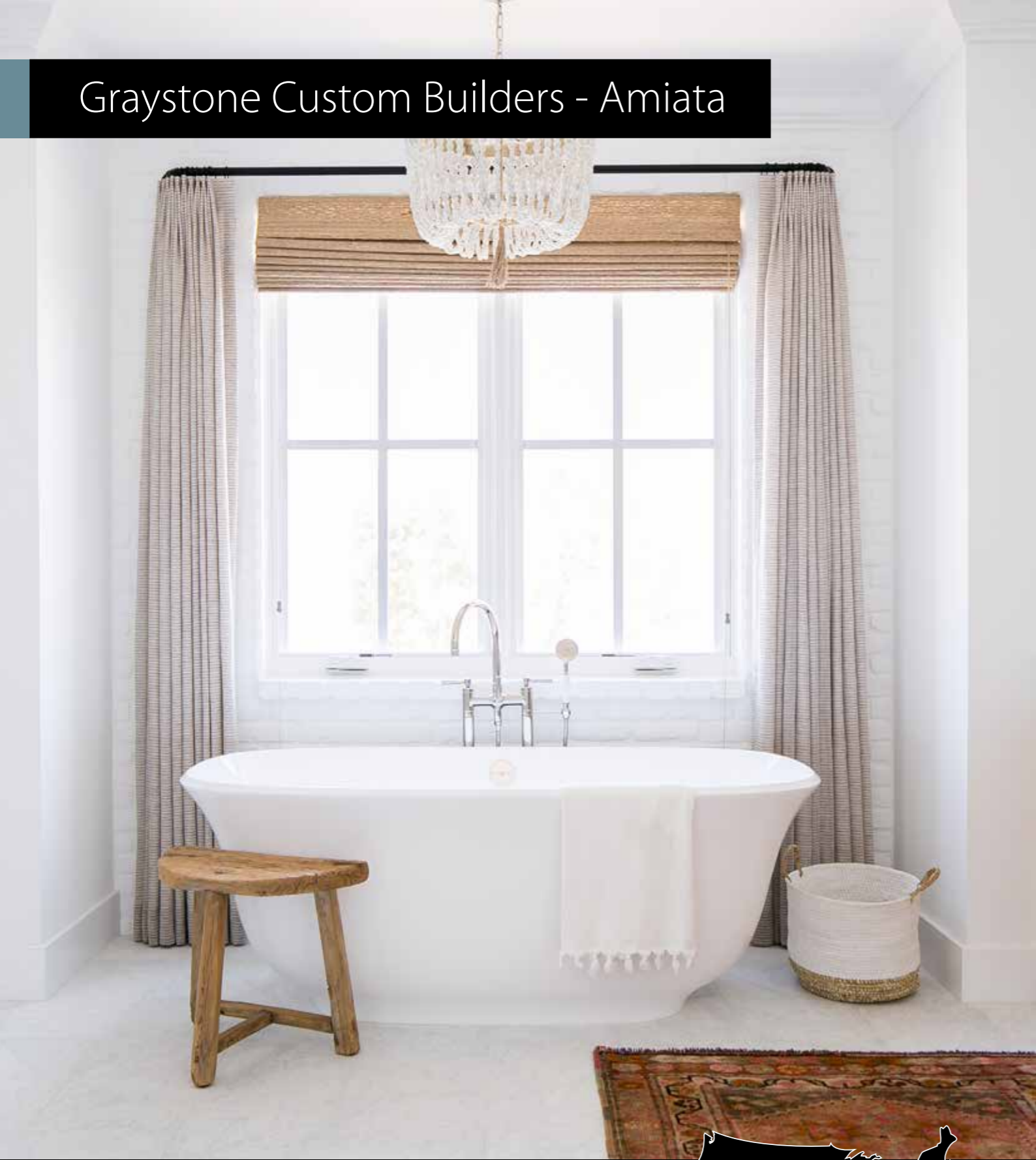

Lido Isle, California, USA

Photography by: Ryan Garvin

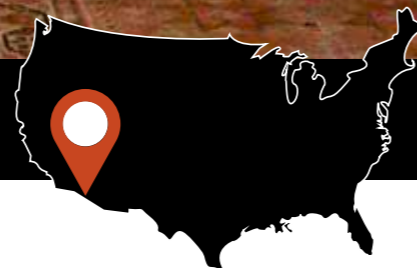

○ AMT-N-SW-NO  ↓ AMT-N-xx-NO 

CE  Massachusetts Code
cUPC listing by IAPMO
Registered Design

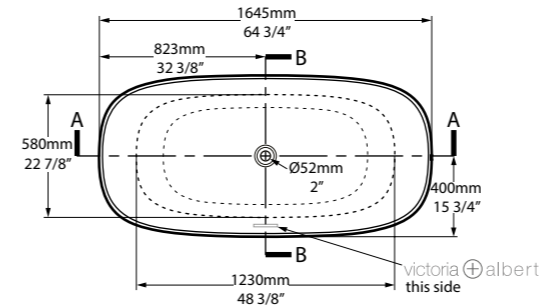

Top View

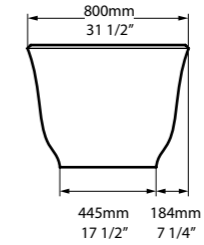

Front View

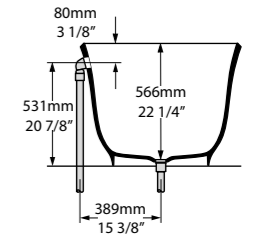

Section BB

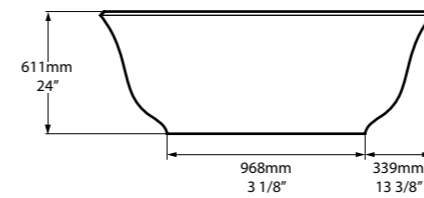

Side View

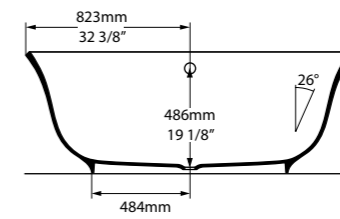

Section AA

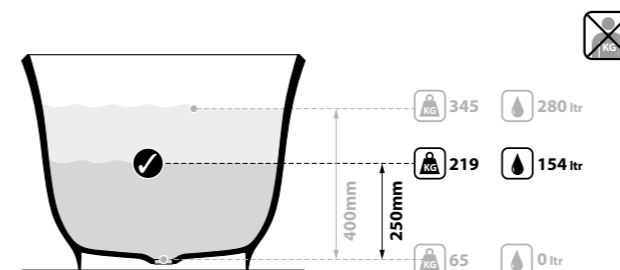

SW  rich in Volcanic Limestone  AN BK GR MB MW SG

Barcelona

Inspiré par la ville célèbre pour son design organique, le modèle Barcelona se caractérise par des courbes opulentes - idéal pour ceux qui apprécient les joies d'un bain luxueux. A associer aux vasques Barcelona 48, Barcelona 55 et Barcelona 64 (page 152-157). Disponible en sept couleurs. Voir aussi la baignoire compacte Barcelona 2 ou Barcelona 3 qui sont dotées d'un vide sanitaire.

Inspiriert von der gleichnamigen Stadt und deren Hang zum organischen Design beweist die Barcelona Wanne eine ausladende Form - perfekt für alle, die gerne luxuriös baden. Zu kombinieren mit den Waschbecken Barcelona 48, Barcelona 55 oder Barcelona 64 (Seite 152-157). Erhältlich in 7 Außenfarben.

Beachten Sie auch unsere kompakten Modelle Barcelona 2 und Barcelona 3, beide mit unten liegendem Hohlraum.

Ispirata alla famosa città per il suo design organico, la vasca Barcelona è caratterizzata da curve sfarzose, ideale per chi desidera un vero bagno di lusso. Complementata dai lavabi Barcelona 48, Barcelona 55 o Barcelona 64 (pagina 152-157). Disponibile in sette finiture di colore.

Vedi inoltre la compatta Barcelona 2, o Barcelona 3, che è caratterizzata da uno spazio vuoto.

Geïnspireerd door de stad die beroemd werd om zijn organische architecturen, toont de Barcelona ons haar welvende vormen. Perfect voor hen voor wie een luxe bad een passie is. Aangevuld met de Barcelona 48, Barcelona 55 of Barcelona 64 wasbak (pg 152-157). Verkrijgbaar in zeven kleurafwerkingen.

Zie ook de kleinere Barcelona 2 of de Barcelona 3, beide met een dubbele bodem.

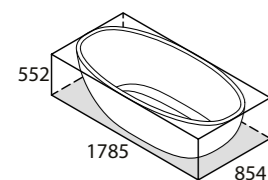

○ BAR-N-SW-NO
■ BAR-N-xx-NO
87Kg



Collections connexes / Entsprechendes Zubehör / Collezioni correlate / Gerelateerde collecties



⊕ Soriano 14
Page 256



⊕ Barcelona 55
Page 154



⊕ Soriano 16
Page 257

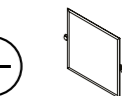

⊕ Anatolia 56
Page 236



Austin, Texas, USA

Photography by: Casey Dunn



○ BAR-N-SW-NO  ↓ BAR-N-xx-NO 

CE  Massachusetts Code
cUPC listing by IAPMO

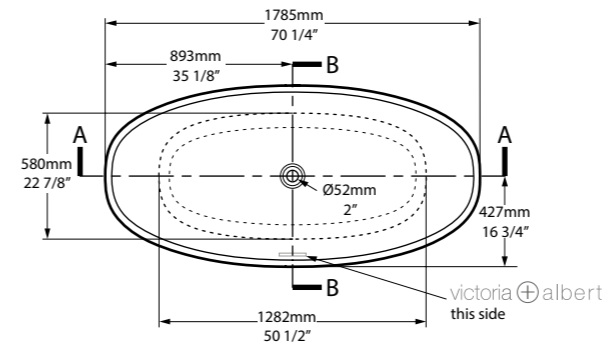

Top View

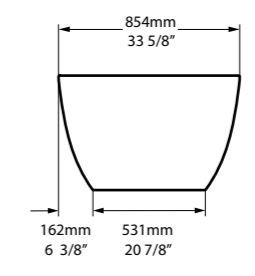

Front View

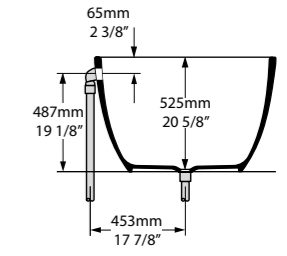

Section BB

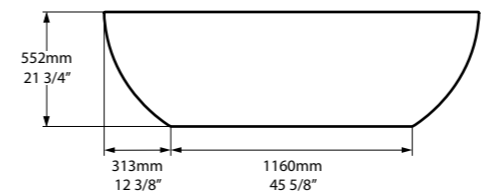

Side View

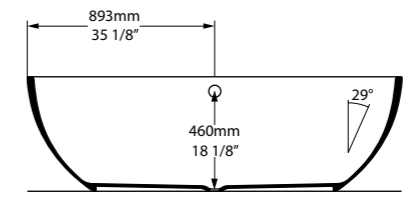

Section AA

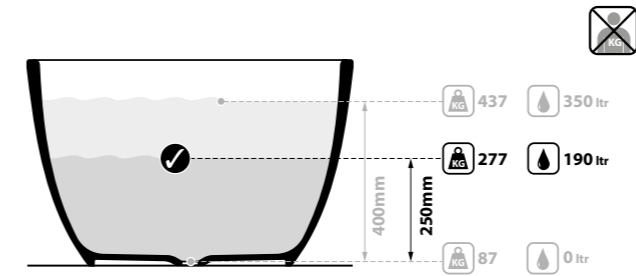

SW  rich in Volcanic Limestone™  AN BK GR MB MW SG



NEW Barcelona 2

○ BA2-N-SW-NO ↓ BA2-N-xx-NO

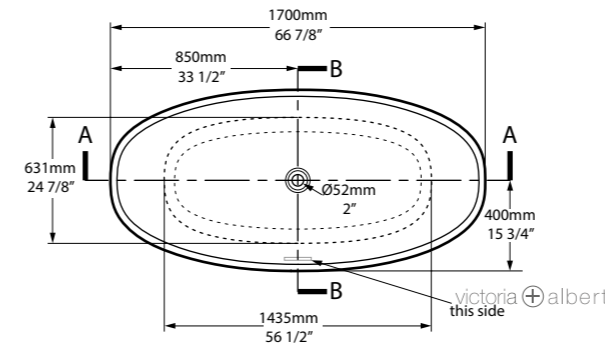

Top View

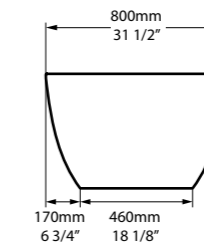

Front View

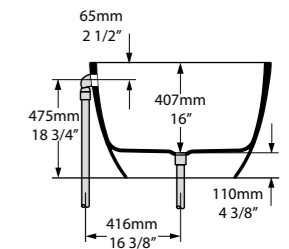

Section BB

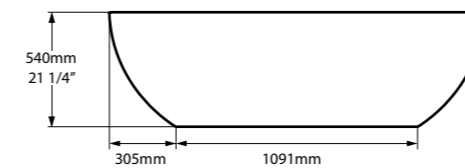

Side View

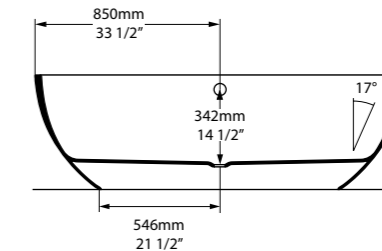

Section AA

Barcelona 2 suit la même conception esthétique que le modèle très apprécié Barcelona mais dispose quant à elle de dimensions plus compactes. La baignoire dispose également d'un vide sanitaire en-dessous pour le système d'évacuation. A associer aux vasques Barcelona 48, Barcelona 55 ou Barcelona 64 (page 152-157). Disponible en sept couleurs.

Voir aussi deux formats plus grands : Barcelona ou Barcelona 3 qui dispose d'un vide sanitaire.

Die Barcelona 2 folgt dem gleichen Design wie die beliebte Barcelona Wanne, hat jedoch kompaktere Maße. Zudem besitzt die Wanne einen unten liegenden Hohlraum für die Abflussrohre. Zu kombinieren mit den Becken Barcelona 48, Barcelona 55 oder Barcelona 64 (Seiten 152-157). Erhältlich in 7 Außenfarben.

Beachten Sie auch die beiden größeren Modelle: Barcelona sowie Barcelona 3 mit Hohlraum.

Barcelona 2 segue lo stesso design estetico della famosa vasca Barcelona, ma con dimensioni più compatte. LA vasca dispone inoltre di uno spazio vuoto sotto per l'impianto idraulico. Completato dai lavabi Barcelona 48, Barcelona 55 o Barcelona 64 (pagina 152-157). Disponibile in sette finiture di colore.

Vedi inoltre due formati più grandi; Barcelona, o Barcelona 3, caratterizzata da uno spazio vuoto.

Barcelona 2 volgt dezelfde ontwerpethetiek als het populaire Barcelona-bad, maar dan met compactere afmetingen. Het bad heeft bovendien een dubbele bodem voor eenvoudige installatie van leidingwerk. Aangevuld met de wasbakken Barcelona 48, Barcelona 55 of Barcelona 64 (pagina 152-157). Verkrijgbaar in zeven kleurenafwerkingen.

Zie ook de twee grotere afmetingen; Barcelona of Barcelona 3 (laatste met dubbele bodem).

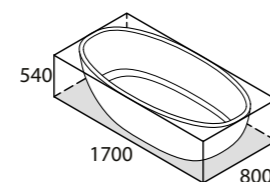
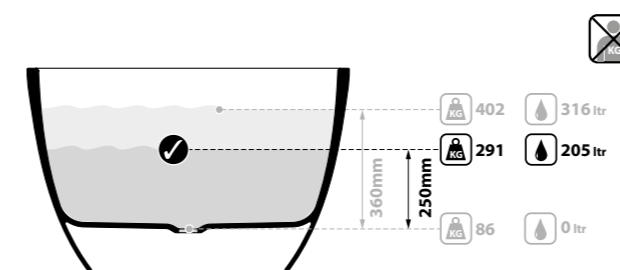

○ BA2-N-SW-NO
↓ BA2-N-xx-NO
86Kg





○ BA3-N-SW-NO ↓ BA3-N-xx-NO

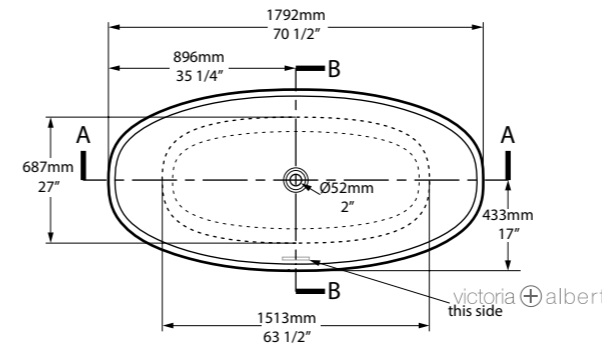

Top View

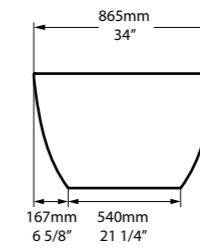

Front View

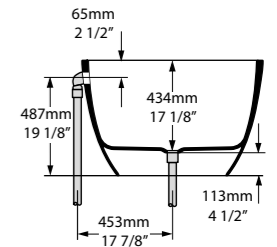

Section BB

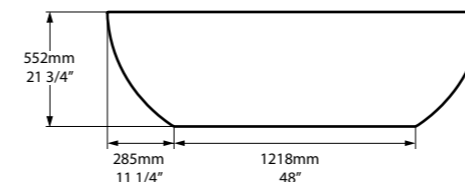

Side View

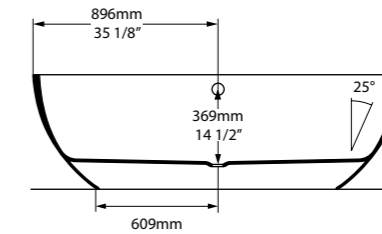

Section AA

Barcelona 3 suit la même conception esthétique que la baignoire Barcelona mais dispose d'un vide sanitaire en-dessous pour le système d'évacuation. A associer aux vasques Barcelona 48, Barcelona 55 ou Barcelona 64 (page 152 – 157). Disponible en sept couleurs.

Voir aussi deux autres formats : Barcelona, sans vide sanitaire, ou la baignoire plus compacte Barcelona 2.

Die Barcelona 3 wurde nach der Ästhetik der beliebten Barcelona Wanne gestaltet, besitzt jedoch einen unten liegenden Hohlraum für die Abflussrohre. Zu kombinieren mit den Becken Barcelona 48, Barcelona 55 oder Barcelona 64 (Seiten 152 – 157). Erhältlich in 7 Außenfarben.

Beachten Sie auch die beiden anderen Modelle: Barcelona ohne Hohlraum sowie die kompaktere Barcelona 2.

Barcelona 3 segue lo stesso design estetico della vasca Barcelona, ma dispone di uno spazio vuoto sotto per l'impianto idraulico. Completata dai lavabi Barcelona 48, Barcelona 55 o Barcelona 64 (pagina 152 – 157). Disponibile in sette finiture di colore.

Vedi inoltre gli altri due formati: Barcelona, senza spazio vuoto, o la piu' compatta Barcelona 2.

Barcelona 3 volgt dezelfde ontwerpethetiek als het Barcelona-bad, maar heeft daarentegen een dubbele bodem, voor eenvoudige installatie van leidingwerk. Aangevuld met de wasbakken Barcelona 48, Barcelona 55 of Barcelona 64 (pagina 152 – 157). Verkrijgbaar in zeven kleurenafwerkingen.

Zie ook 2 andere afmetingen: Barcelona (zonder dubbele bodem) of de meer compactere Barcelona 2 (met dubbele bodem).

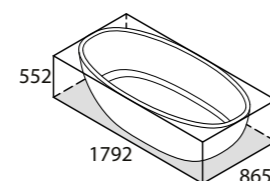
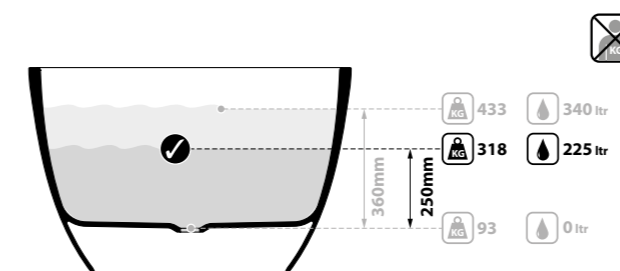

○ BA3-N-SW-NO
↓ BA3-N-xx-NO
93Kg





Avec ses lignes épousant les courbes du corps, Cabrits s'adapte à chacun. Sa forme unique avec un bassin de chaque côté en fait l'une des baignoires les plus confortables qui soit et, de plus, sa capacité de seulement 176 litres fait d'elle l'une des plus économes en eau de toute la gamme Victoria + Albert. A associer à la vasque Cabrits 55 (page 158). Disponible en sept couleurs.

Mit Kurven, die sich geradezu an den Körper anschmiegen, bietet die Cabrits Wanne herausragenden Komfort für Badeliebhaber unterschiedlichster Körpergröße. Das originelle "Tandem" Design macht sie zu einer der bequemsten und komfortabelsten Wannen überhaupt. Gleichzeitig ist sie dank ihres maximalen Wasservolumens von gerade einmal 176 Litern die wassereffizienteste Wanne im Victoria + Albert Produktsortiment. Zu kombinieren mit dem Becken Cabrits 55 (Seite 158). Erhältlich in 7 Außenfarben.

Sagomata per adattarsi alla persona, la vasca Cabrits offre un supporto ideale ad ogni tipo di corpo. Il suo design speciale "double dip", ovvero a "doppia caduta", la rende una delle vasche più confortevoli sul mercato e, con una capacità massima di soli 176 litri, anche la miglior vasca "salva acqua" della collezione Victoria + Albert. Complementata dal lavabo di design Cabrits 55 (pagina 158). Disponibile in sette finiture di colore.

De Cabrits biedt een uiterst comfortabele en perfecte ondersteuning aan het gehele lichaam, voor zowel mensen met een groot als ook een kleiner postuur. Het speciale 'double dip' ontwerp verhoogt het comfort van het bad en is met maximaal 176 Liter tegelijkertijd ook het meest waterbesparende bad uit de collectie van Victoria + Albert. Aangevuld met de Cabrits 55 wasbak (pg 158). Verkrijgbaar in zeven kleurafwerkingen.

Collections connexes / Entsprechendes Zubehör / Collezioni correlate / Gerelateerde collecties

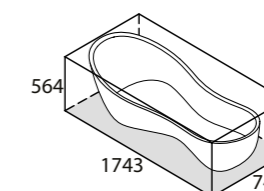

○ CAB-N-SW-NO
 ■ CAB-N-xx-NO
 63Kg





Victoria, Australia

Photography by: Aysha Lawson

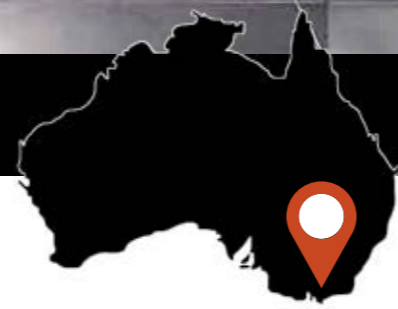

○ CAB-N-SW-NO  ↓ CAB-N-xx-NO 

CE  Massachusetts Code cUPC listing by IAPMO Registered Design

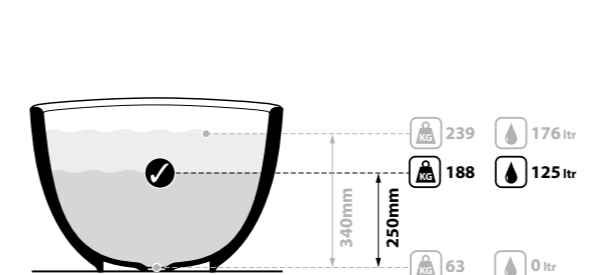
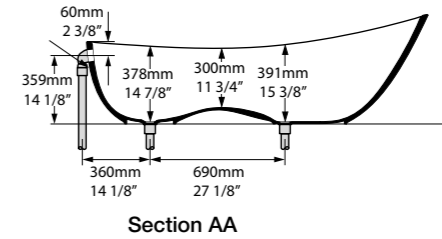
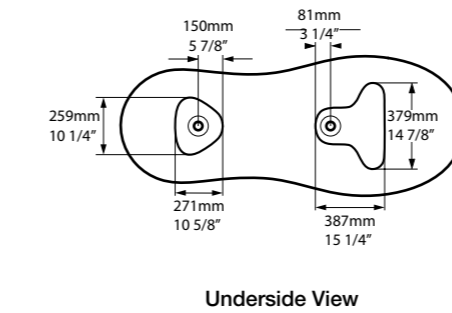
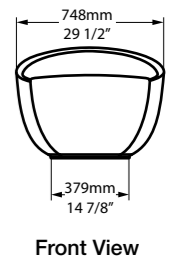
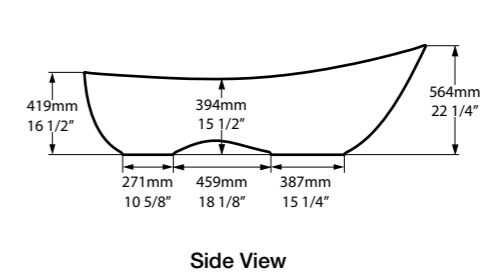
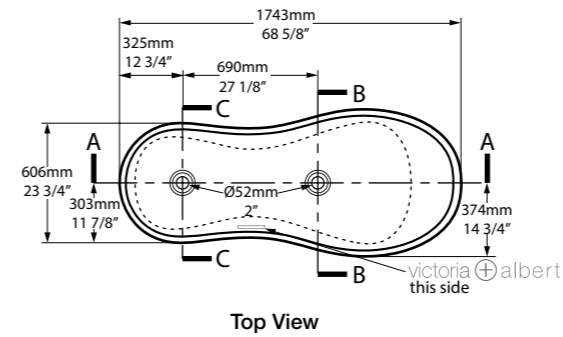

  rich in Volcanic Limestone       



Un classique éternel : la baignoire à double assise de style Victorien offre en option une gamme de pieds "griffes" déclinée en plusieurs finitions. Disponible en sept couleurs. Une gamme de finitions pour pieds en métal est disponible - voir page suivante.

Der zeitlose Klassiker - eine tiefe Wanne im viktorianischen Stil mit einer Auswahl unterschiedlicher Ball- und Klauenfüße. Erhältlich in 7 Außenfarben. Eine Auflistung der verfügbaren Metalloberflächen für die Füße finden Sie auf der nächsten Seite.

Un classico senza tempo - un'ampia vasca Vittoriana a doppio schienale di proporzioni generose che offre una vasta gamma di piedi favolosi formati da artigli appoggiati su sfere. Disponibile in sette finiture di colore. E' disponibile una gamma di finiture per piedini in metallo - vedi nella pagina seguente.

De tijdloze klassieker - een diep Victoriaans dubbelzijdige Roll-Top bad met verschillende Ball & Claw poot opties. Een gamma van afwerkingen van metaal poten zijn beschikbaar (zie volgende blz).

Collections connexes / Entsprechendes Zubehör / Collezioni correlate / Gerelateerde collecties

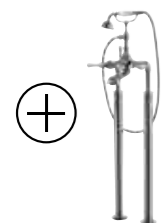

Staffordshire 26
Page 271

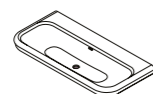

Lario 100 Solo
Page 180



Staffordshire 9
Page 265

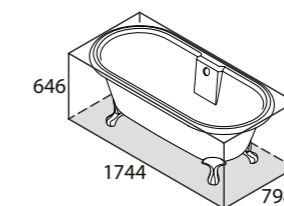

○ CHE-N-SW-OF
■ CHE-N-xx-OF
57Kg



Babylonstoren, Franschhoek, South Africa

Photography by: Babylonstoren



○ CHE-N-SW-OF  ↓ CHE-N-xx-OF 

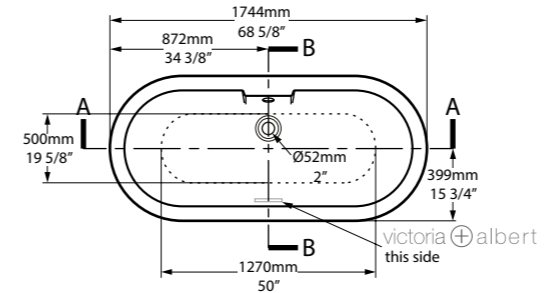

Top View

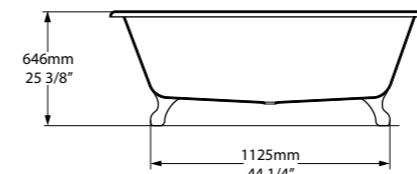

Side View

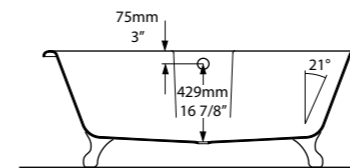

Section AA



Front View

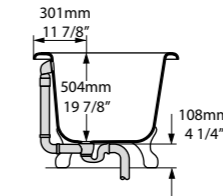

Section BB



 Tap holes can be drilled by installer
 Armaturenlöcher können leicht vom Installateur gebohrt werden
 Les trous de robinetterie peuvent être percés par l'installateur
 Pueden ser perforados por el instalador
 I fori per rubinetti possono essere perforati dall'installatore

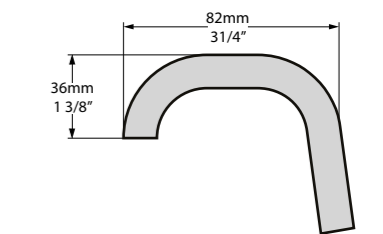
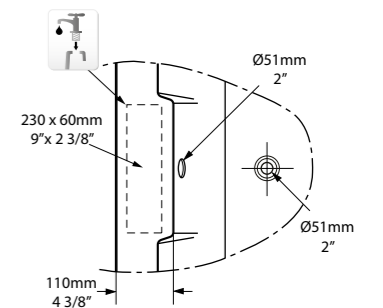

Rim Detail

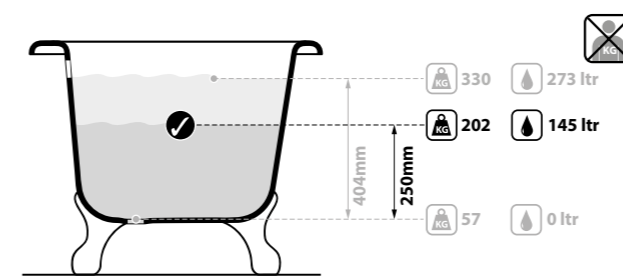

S'inspirant des formes de la traditionnelle baignoire Sabot Victorienne et de l'opulence contemporaine, la baignoire Drayton, caractérisée par un magnifique rebord, dispose d'une taille généreuse et offre un soutien des épaules optimal pour une parfaite expérience du bain. Accompagnée par la vasque Drayton 40 (page 160). Disponible en sept couleurs. Une gamme de finitions pour pieds en métal est disponible - voir page suivante.

Die Drayton Wanne entspricht in ihrer Form der original viktorianischen Slipper Wanne - plus moderner Opulenz und wunderschönen Randdetails. Ihre großzügigen Abmessungen und die bequeme Schulterpositionierung garantieren ein außergewöhnliches Baderlebnis. Zu kombinieren mit dem Drayton 40 Waschbecken (Seite 160). Erhältlich in 7 Außenfarben. Eine Auflistung der verfügbaren Metalloberflächen für die Füße finden Sie auf der nächsten Seite.

Prendendo la sua forma dalla vasca Vittoriana originale, ma con l'aggiunta di un'abbondanza dei giorni nostri, la vasca Drayton è fine ma con un'ampio e bellissimo bordo; offre dimensioni generose e un supporto per le spalle per godere al massimo un'esperienza sublime. Complementata dal lavabo Drayton 40 (pagina 160). Disponibile in sette finiture di colore. È disponibile una gamma di finiture per piedini in metallo - vedi nella pagina seguente.

Uitgaande van de originele Victoriaanse slipper bad vorm met toevoeging van modern comfort en mooie rand detaillering, biedt de Drayton met zijn royale afmetingen en schouder-ondersteuning een sublieme badervaring. Aangevuld met de Drayton 40 wasbak (pg 160). Verkrijgbaar in zeven kleuraferwerkingen. Een gamma van afwerkingen van metaal poten zijn beschikbaar (zie volgende blz).

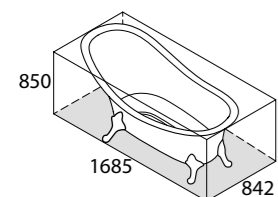

○ DRA-N-SW-OF
 ■ DRA-N-xx-OF
 65Kg



Collections connexes / Entsprechendes Zubehör / Collezioni correlate / Gerelateerde collecties

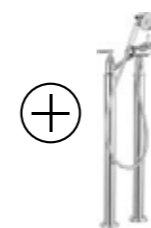

Florin 26
Page 249

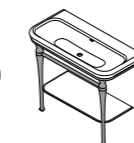

Candella 100
Page 194



Florin 9
Page 245



Anatolia 55
Page 234



CE Massachusetts Code cUPC listing by IAPMO Registered Design

○ DRA-N-SW-OF ↓ DRA-N-xx-OF

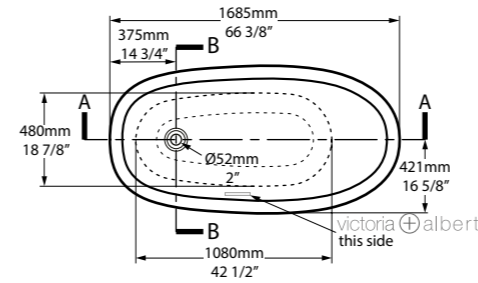

Top View

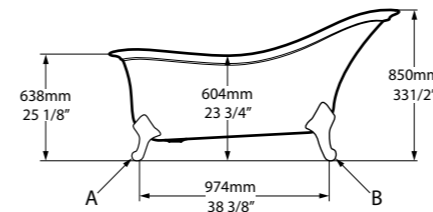

Side View

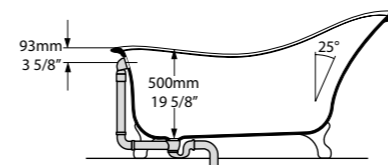

Section AA



Front View

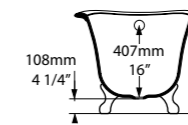

Section BB

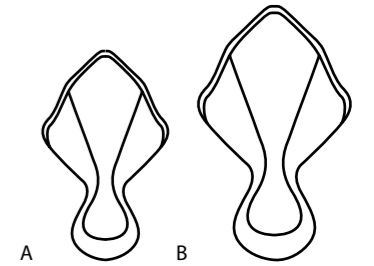

A

B

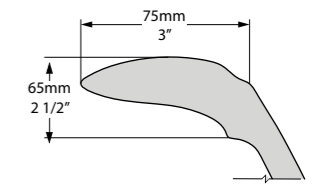

Rim Detail

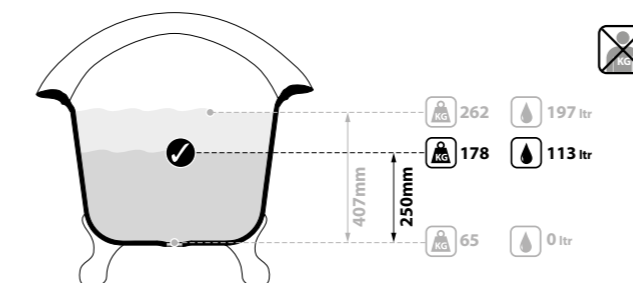

rich in Volcanic Limestone™



Edge

Profondeur généreuse et double assise luxueuse dans un format compact. Le modèle Edge possède la plupart des qualités de la baignoire ios, le style cubique en plus. Edge dispose d'un vide sanitaire en-dessous pour le système d'évacuation. Accompagnée par la vasque Edge 45 (page 162). Disponible en sept couleurs.

Tiefe, doppelseitige Luxuswanne mit kompaktem Format. Edge teilt viele Vorzüge der ios, bietet aber als Extra einen markanten, kubischen Stil und einen unten liegenden Hohlraum für die Abflussrohre. Zu kombinieren mit dem Edge 45 Waschbecken (Seite 162). Erhältlich in 7 Außenfarben.

Con doppio schienale, profonda ed elegante in un formato compatto. La vasca Edge condivide molte delle qualità della vincente ios, con l'aggiunta dello distintivo stile cubico. Complementato dal lavabo Edge 45 (pagina 162). Disponibile in sette finiture di colore.

Diepe, dubbelzijdige luxe in een compacte vormgeving. De Edge heeft veel gemeen met de ios, met een gedistingeerde rechthoekige styling en dubbele bodem voor eenvoudige sifon installatie. Aangevuld met de Edge 45 wasbak (pg 162). Verkrijgbaar in zeven kleurafwerkingen.

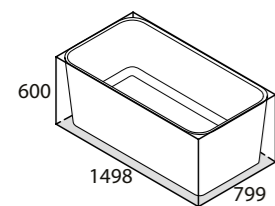

○ EDG-N-SW-NO
■ EDG-N-xx-NO
85Kg

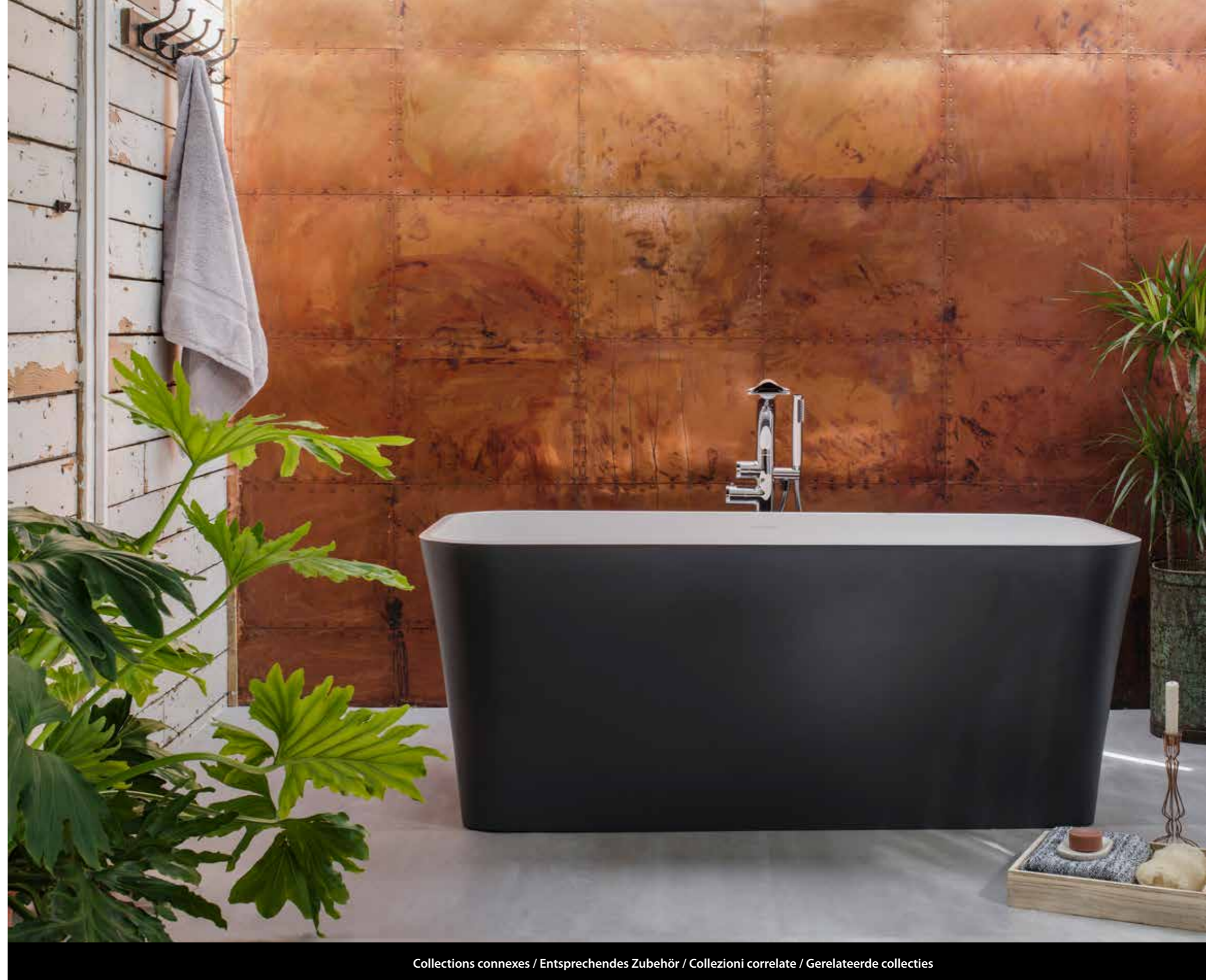

Collections connexes / Entsprechendes Zubehör / Collezioni correlate / Gerelateerde collecties



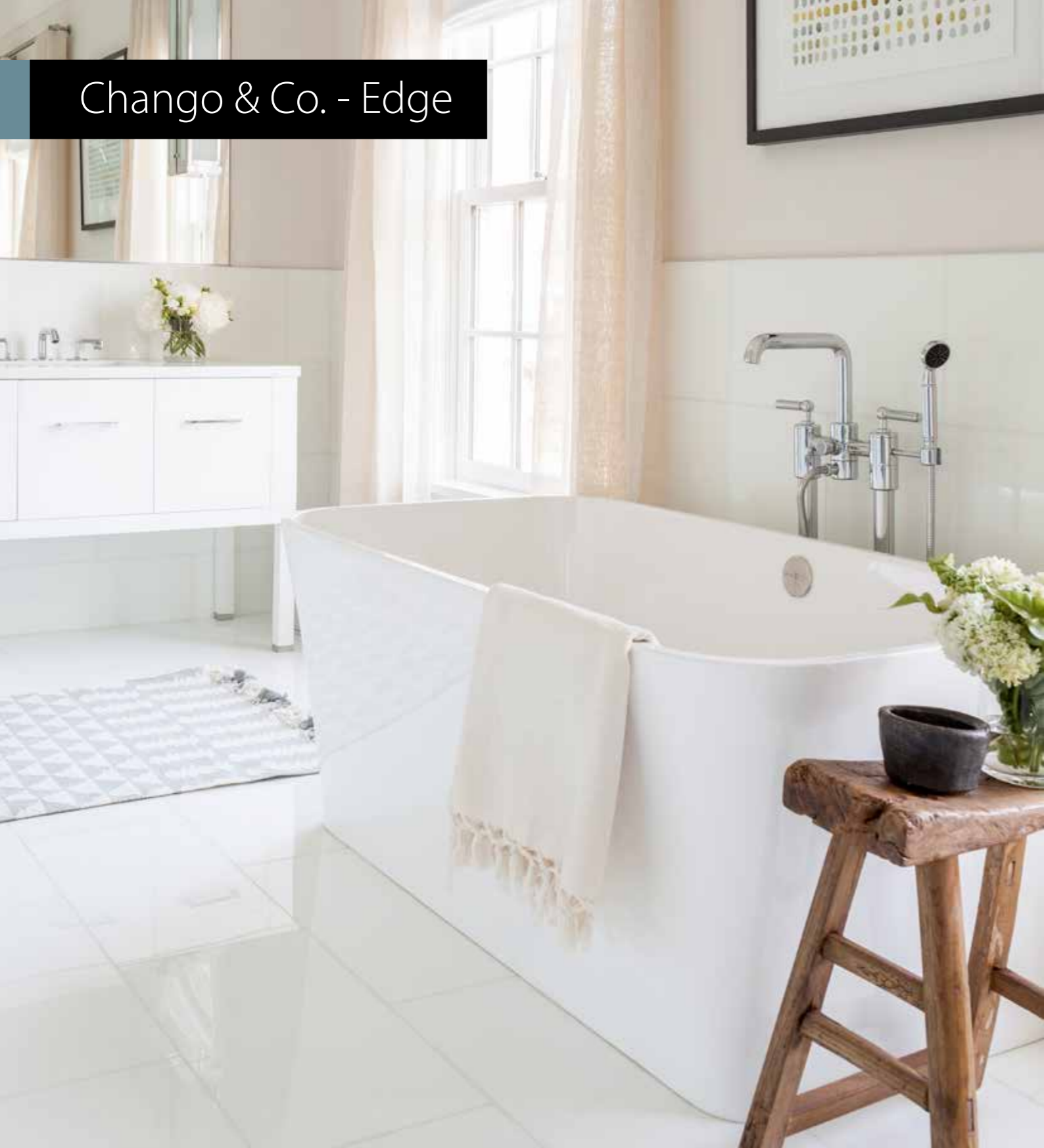

○ EDG-N-SW-NO  † EDG-N-xx-NO 

CE  Massachusetts Code
cUPC listing by IAPMO

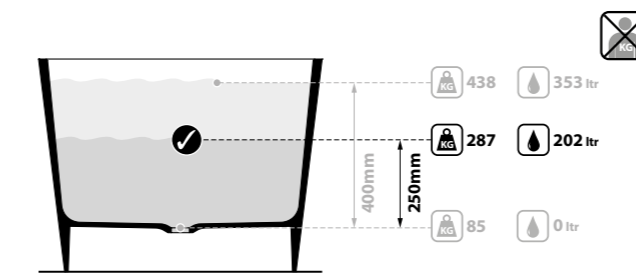
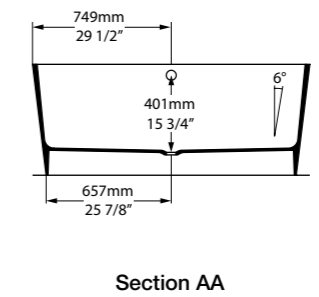
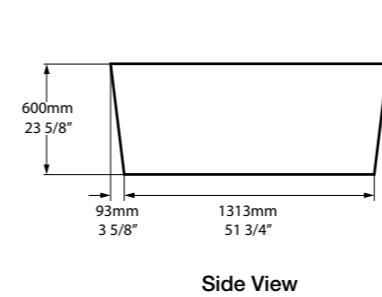
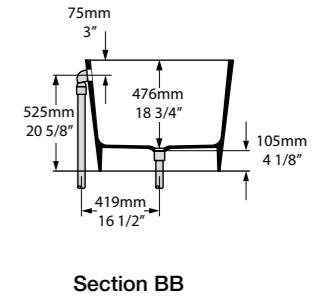
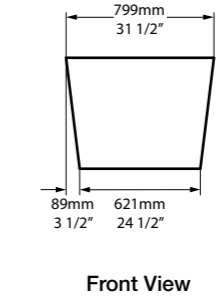
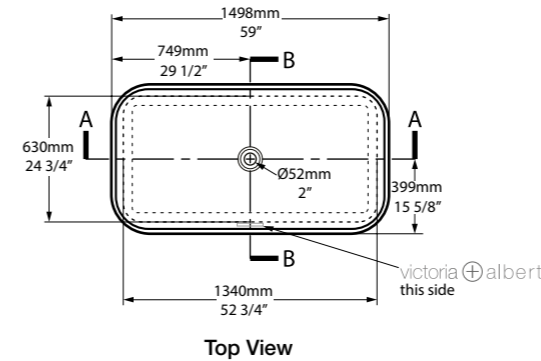

Westport, Connecticut, USA

Photography by: Raquel Langworthy



SW  rich in Volcanic Limestone™  AN  GR  MW 

CONRAN+ PARTNERS

Eldon est la création de Conran + Partners, un cabinet d'architecture et de design intérieur britannique de renom, qui a appliqué son expertise acquise lors de la conception de quelques-uns des plus grands hôtels et résidences du monde.

La baignoire murale contemporaine est dotée de lignes généreuses propres aux baignoires en îlot. Les robinets peuvent être installés sur la large surface plane et un rebord moulé permet d'installer aisément le carrelage. Dispose d'un vide sanitaire en-dessous pour le système d'évacuation.

Avec ses 1750mm de long, c'est la baignoire parfaite pour les salles de bains spacieuses ou petites, dans lesquelles les lignes épurées et la praticité sont tout aussi importantes. Disponible en sept couleurs.

Die Eldon Wanne ist eine Kreation des führenden britischen Designstudios Conran + Partners, das all seine Erfahrungen in das Projekt einfließen ließ, die es bei der Gestaltung einiger weltweiten Top Hotels und Resorts gesammelt hat.

Die moderne Back-to-Wall Wanne besitzt die üppigen Ausmaße einer freistehenden Wanne. Die Armaturen können auf dem breiten Sockel montiert werden, und die gegossene Aufkantung ermöglicht das leichte Anbringen von Kacheln. Mit einem unten liegenden Hohlraum für die Abflussrohre.

Mit einer Länge von 1750mm ist sie die perfekte Wanne für große oder kleine Badezimmer, in denen klare Linien und hohe Funktionalität gewünscht sind. Erhältlich in 7 Außenfarben.

Eldon e' la creazione dello studio Leader britannico British Architecture and Interior Design Studio, Conran + Partners, che hanno applicato la loro competenza attraverso l a progettazione di alcuni dei migliori hotel e residence di tutto il mondo.

La vasca contemporanea a muro e' dotata di linee curve come una vasca freestanding. Il rubinetto a pavimento nasconde tutto il tubo di scarico ed un'alazatina sagomata permette di installare le piastrelle facilmente.

Con una lunghezza di 1750mm, e' la vasca perfetta per stanze da bagno piccole e grandi, dove le linee pulite e la pulizia di ogni giorno sono importanti in ugual modo. Disponibile in sette finiture cromatiche esterne.

Eldon is ontworpen door één van de meest vooraanstaande Britse Architectuur en Interior Design Studios, Conran + Partners, die hun expertise in het ontwerpen van een aantal van 's werelds beste hotels en woningen, hier op hebben toegepast.

Het moderne bad dat tegen de muur geplaatst wordt, wordt gekenmerkt door de ronde lijnen van een vrijstaand bad. Een badkraan kan op de badrand geïnstalleerd worden en de gegoten opstaande rand biedt eenvoudige betegeling. De dubbele bodem zorgt verder voor eenvoudige afvoer installatie.

Met zijn 1750mm lengte, is het een perfecte bad voor zowel grote als kleinere badkamers, waar strakke lijnen en de dagelijkse bruikbaarheid even belangrijk zijn. Verkrijgbaar in zeven kleurafwerkingen.

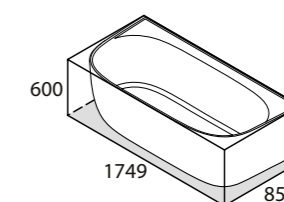

- ELD-N-SW-NO
- ELD-N-xx-NO
- ELD-N-SW-OF
- ELD-N-xx-OF

109kg

Collections connexes / Entsprechendes Zubehör / Collezioni correlate / Gerelateerde collecties



Tubo 31 42 43 + Hub 01
Page 286 + 243

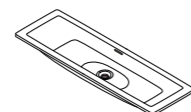

Rossendale 91
Page 186



Tubo 17
Page 280



- ELD-N-SW-NO     
- ELD-N-SW-OF     

  Massachusetts Code
cUPC listing by IAPMO

 Tap holes can be drilled by installer
Armaturenlöcher können leicht vom Installateur gebohrt werden
Les trous de robinetterie peuvent être percés par l'installateur
Pueden ser perforados por el instalador
I fori per rubinetti possono essere perforati dall'installatore

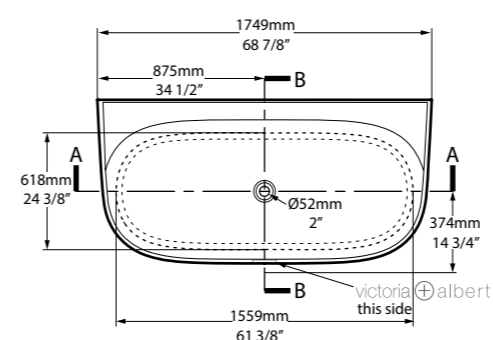

Top View

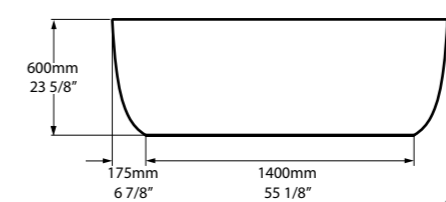

Front View

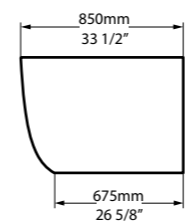
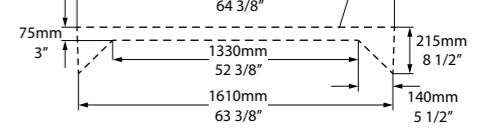
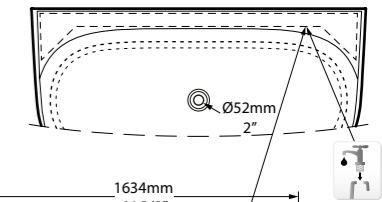

Side View

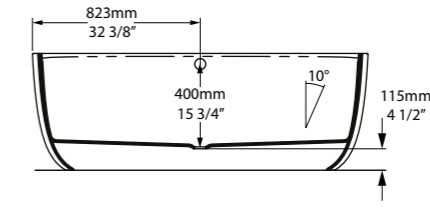

Section AA

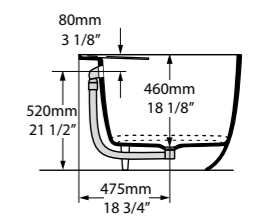

Section BB

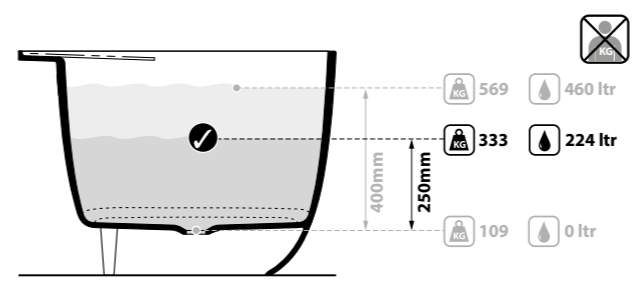

- 
-  rich in Volcanic Limestone
- 
- 
- 
- 
- 
- 
- 

Elwick est une généreuse baignoire à double assise montée sur un socle afin de dissimuler le système d'évacuation. Les détails subtils font rentrer la forme traditionnelle dans la période moderne. A associer à la vasque Radford 51 (page 172). Disponible en sept couleurs.

Die Elwick ist eine großzügig bemessene Double-End Wanne, montiert auf einem Sockel, der die Abflussrohre verbirgt. Schlichte Randverzierungen verbinden die klassische Form mit modernem Anspruch. Zu kombinieren mit dem Radford 51 Waschbecken (Seite 172). Erhältlich in 7 Außenfarben.

La vasca freestanding Elwick con bordo dettagliato, vanta una forma generosa a doppia seduta, ed e' montata su una base di piedistallo per nascondere lo scarico. Accompagnata dal lavabo Radford 51 (pagina 172). Disponibile in sette finiture di colore.

Het model Elwick is een ruime dubbelzijdig bad op een sokkel zodat leidingen verborgen blijven. Subtiële rand detaillering, zorgt voor een traditionele vorm in het hedendaagse. Aangevuld met de Radford 51 wasbak (pg 172). Verkrijgbaar in zeven kleurafwerkingen.

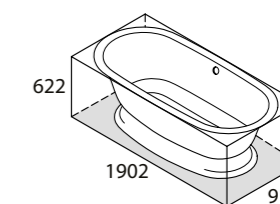

○ RAD-N-SW-OF + ELW-B-SW
 ■ RAD-N-xx-OF + ELW-B-xx
 82Kg

Collections connexes / Entsprechendes Zubehör / Collezioni correlate / Gerelateerde collecties

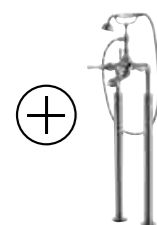

Staffordshire 26
 Page 271

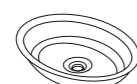

Radford 51
 Page 172



Staffordshire 11
 Page 267



London, United Kingdom

Photography by: Chris Everard



○ RAD-N-SW-OF + ELW-B-SW © ♣ RAD-N-xx-OF + ELW-B-xx ©

CE  Massachusetts Code
cUPC listing by IAPMO
Registered Design

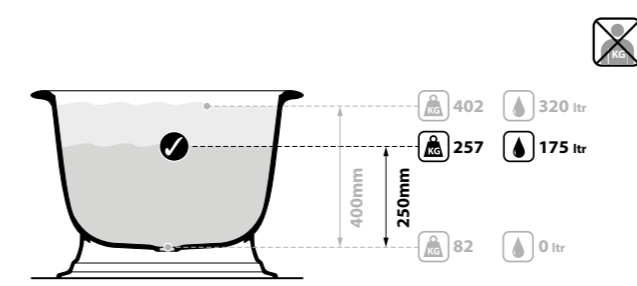
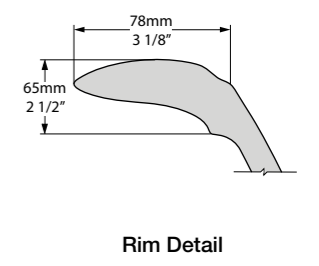
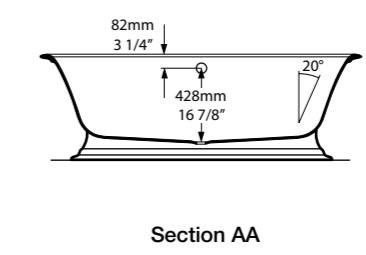
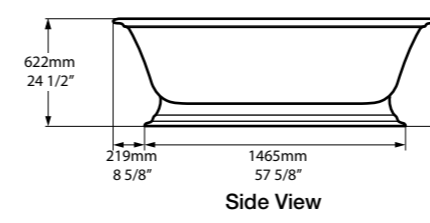
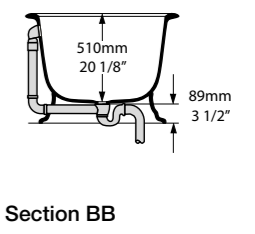
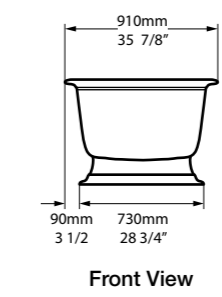
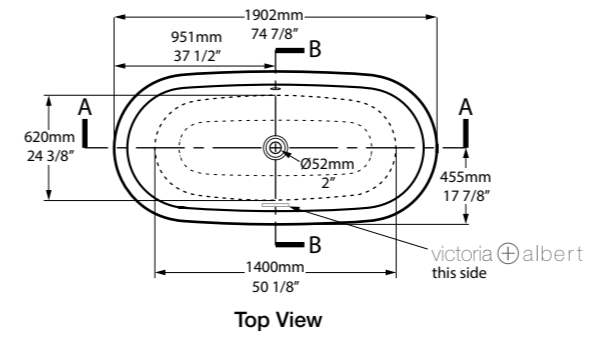

SW  rich in Volcanic Limestone   AN  BK  GR  MB  MW  SG

Hampshire

La baignoire Edwardienne par excellence pour répondre aux exigences du baigneur raffiné, ses parois intérieures s'inclinent à l'angle idéal pour un confort optimum. Disponible en sept couleurs. Une gamme de finitions pour pieds en métal est disponible - voir page suivante.

Diese klassische Wanne aus der Edwardischen Epoche wird von den anspruchsvollsten Badefreunden geliebt. Durch ihren perfekten Liegewinkel bietet sie ein besonders tiefes Eintaucherlebnis. Erhältlich in 7 Außenfarben. Eine Auflistung der verfügbaren Metalloberflächen für die Füße finden Sie auf der nächsten Seite.

Una classica vasca Edwardiana per gli amanti di vasche piu' esigenti. Questa vasca a seduta singola possiede un bordo con angolata perfetta, per assicurare il massimo comfort. Disponibile in sette finiture di colore. E' disponibile una gamma di finiture per piedini in metallo - vedi nella pagina seguente.

Het klassieke Edwardian bad voor de veeleisende bader. Deze eenzijdige Roll Top biedt maximaal comfort. Verkrijgbaar in zeven kleurafwerkingen. Een gamma van afwerkingen van metaal poten zijn beschikbaar (zie volgende blz).

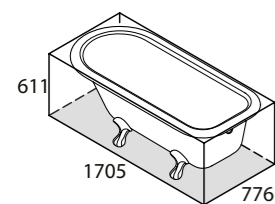

○ HAM-N-SW-OF
■ HAM-N-xx-OF

52Kg



Collections connexes / Entsprechendes Zubehör / Collezioni correlate / Gerelateerde collecties



Staffordshire 15
Page 269



Branxton, New South Wales, Australia



Photography by: Brigid Arnott © House Beautiful



-  FT-HAM-SW
-  FT-HAM-WH
-  FT-HAM-PC
-  FT-HAM-PB
-  FT-HAM-PN
-  FT-HAM-BN

○ HAM-N-SW-OF ◻ ◻ ◻ HAM-N-xx-OF ◻ ◻

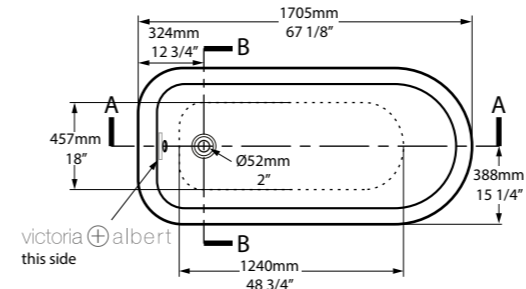

Top View

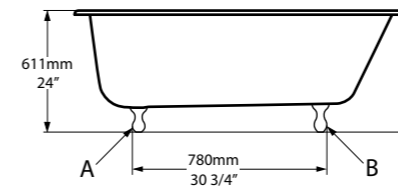

Side View

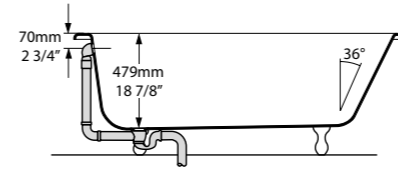

Section AA



Front View

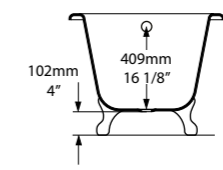

Section BB

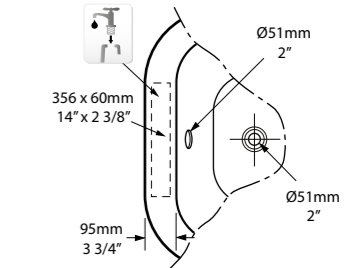

Rim Detail



Tap holes can be drilled by installer
 Armaturenlöcher können leicht vom Installateur gebohrt werden
 Les trous de robinetterie peuvent être percés par l'installateur
 Pueden ser perforados por el instalador
 I fori per rubinetti possono essere perforati dall'installatore

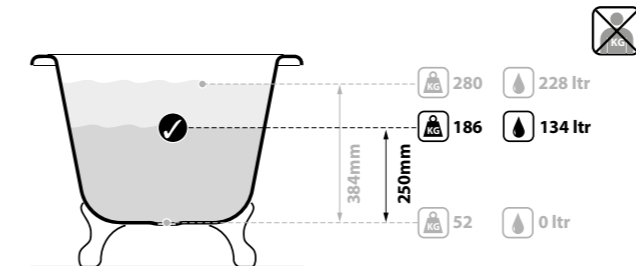

- SW
- Qc rich in Volcanic Limestone
- AN
- BK
- GR
- MB
- MW
- SG

La forme sculpturale de la baignoire à double assise ionian crée un élément central élégant dans une salle de bains moderne. Un rebord distinctif à largeur variable met en valeur le subtil design oval. Un vide sanitaire en-dessous permet de dissimuler le système d'évacuation. Disponible en sept couleurs.

Die skulpturale Anmutung der Double-End Wanne ionian macht sie zum Mittelpunkt jedes modernen Badezimmers. Die randlose Form unterstreicht das harmonische, ovale Design. Mit einem unten liegenden Hohlraum für die Abflussrohre. Erhältlich in 7 Außenfarben.

Dopo il successo della vasca a seduta ios, la vasca ionian la segue, ma e' piu' lunga, ed offre una generosa inclinatura per godere di un piacevole momento di relax. Una distinta larghezza della base esalta il suo design ovale. Disponibile in sette finiture di colore.

De elegante vorm van het dubbelzijdige bad Ionian, maakt dit model tot een pronkstuk in de moderne badkamer. De onderscheidende variabele randbreedte zorgt verder voor de subtiële ovale vormgeving. De dubbele bodem zorgt tevens voor eenvoudige en verborgen leiding/afvoer installatie. Verkrijgbaar in zeven kleurafwerkingen.

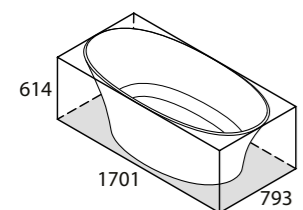

○ INN-N-SW-NO
 ■ INN-N-xx-NO
 82Kg



Collections connexes / Entsprechendes Zubehör / Collezioni correlate / Gerelateerde collecties

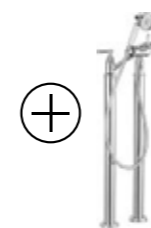

Florin 26
Page 249

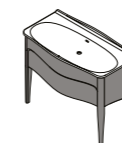

Mandello 114
Page 224



Florin 9
Page 245



Newport Beach, California, USA

Photography by: Jeri Koegel

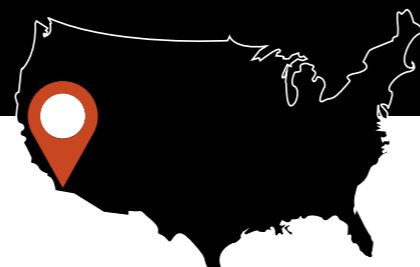

○ INN-N-SW-NO   ♀ INN-N-xx-NO  

CE  Massachusetts Code
cUPC listing by IAPMO

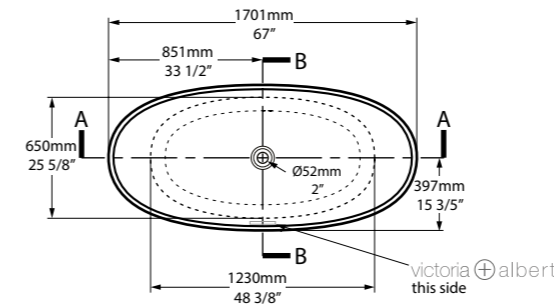

Top View

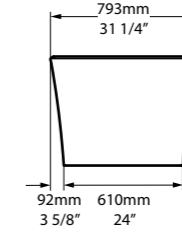

Front View

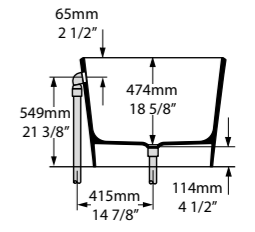

Section BB

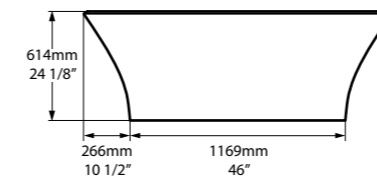

Side View

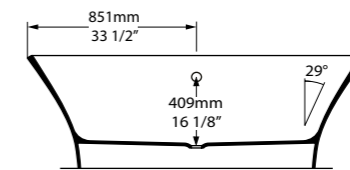

Section AA

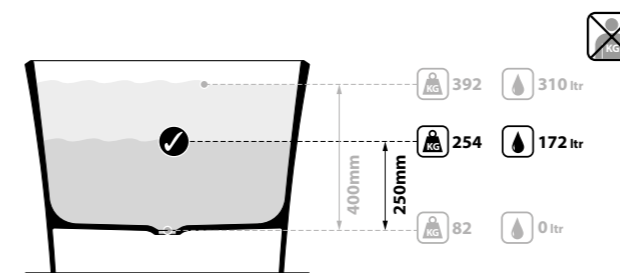

SW  rich in Volcanic Limestone  AN  BK  GR  MB  MW  SG

Pensée pour optimiser l'espace, la ios est conçue pour les appartements citadins et les salles de bains où l'espace est limité. A associer aux vasques ios 54 et ios 80 (page 164–167). Disponible en sept couleurs.

Passend zu der platzsparenden Philosophie randloser Wannen richtet sich das Modell ios an moderne Stadtwohnungen, in denen oft kleine Badezimmer vorherrschen. Zu kombinieren mit den Waschbecken ios 54 oder ios 80 (Seiten 164–167). Erhältlich in 7 Außenfarben.

La progettazione di vasche senza bordo e' basata sulla filosofia "salvaspazio" e la vasca ios e' designata per i moderni appartamenti cittadini e i bagni in camera dove lo spazio è un privilegio. Complementato dai lavabi ios 54 o ios 80 (pagina 164–167). Disponibile in sette finiture di colore.

Voortbouwend op de filosofie van ruimtebesparend en randloos design, is de iosontworpen voor stedelijke appartementen en lofts waar de beperkte ruimte een gegeven is. Aangevuld met de ios 54 of ios 80 wasbak (pg 164–167). Verkrijgbaar in zeven kleurafwerkingen.

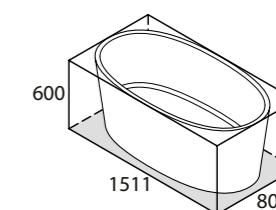

○ IOS-N-SW-NO
 ■ IOS-N-xx-NO
 68Kg

Collections connexes / Entsprechendes Zubehör / Collezioni correlate / Gerelateerde collecties

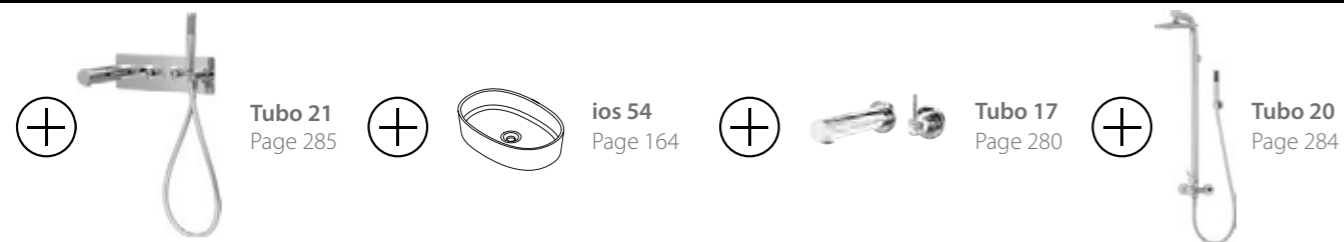



Dallas, Texas, USA

Photography by: Stephen Karlisch

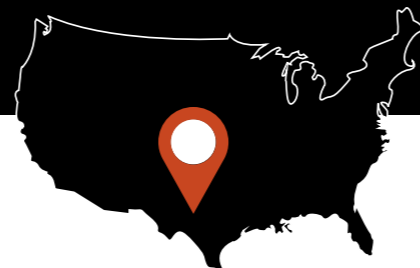

○ IOS-N-SW-NO    

CE  Massachusetts Code
cUPC listing by IAPMO

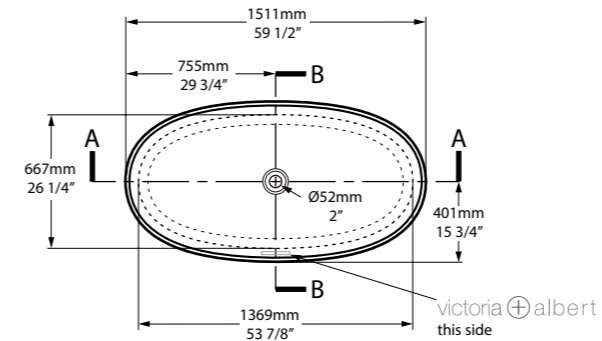

Top View

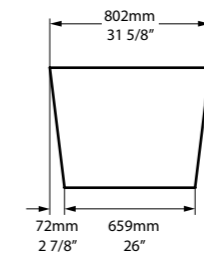

Front View

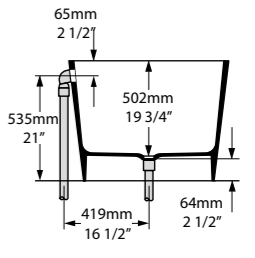

Section BB

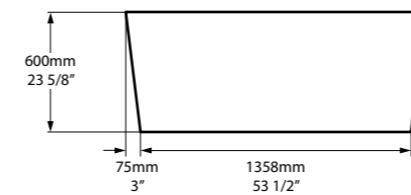

Side View

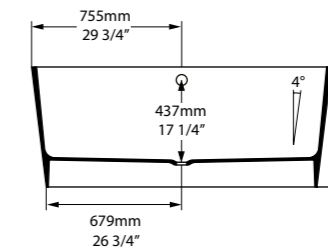

Section AA

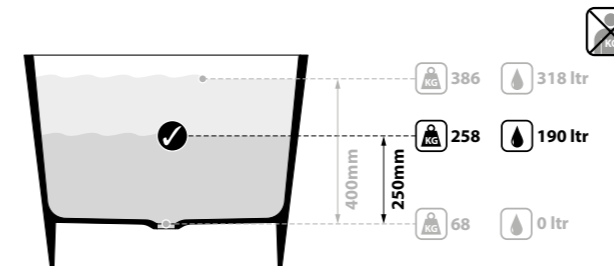

SW  rich in Volcanic Limestone    AN  BK  GR  MB  MW  SG

Une grande baignoire de luxe à double dossier relevé, sur socle. La Marlborough s'inspire de la baignoire "bateau" traditionnelle. Destinée à ceux qui désirent faire preuve d'originalité sur le plan du design avec des touches classiques ou modernes. Disponible en sept couleurs.

Eine große, luxuriöse Wanne mit doppelter Rückenlehne und Sockel. Die Marlborough entspricht der klassischen "Bateau" Wanne. Für diejenigen, die nach einem ganz besonderen Statement in ihrem Badezimmer suchen - sei es modern oder klassisch. Erhältlich in 7 Außenfarben.

Una vasca capiente e lussuosa con seduta a doppio schienale alto. Una vasca per chi vuole abbattere le ultime frontiere nella propria stanza da bagno, che sia moderna o classica. Disponibile in sette finiture di colore.

Een groot luxe dubbelzijdig slipper bad op een sokkel. De vorm van de Marlborough is terug te voeren naar de "bateau" baden. Voor liefhebbers van de ultiem baden, zij het modern of klassiek. Verkrijgbaar in zeven kleurafwerkingen.



Collections connexes / Entsprechendes Zubehör / Collezioni correlate / Gerelateerde collecties

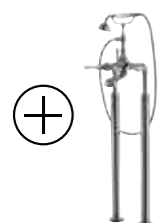

Staffordshire 26
Page 271



Metallo 61 Quartz
Page 202



Staffordshire 9
Page 265



Anatolia 56
Page 236

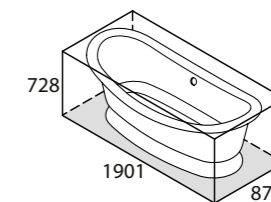

○ MAR-N-SW-OF + MAR-B-SW
■ MAR-N-xx-OF + MAR-B-xx
64Kg



Truckee, California, USA

Photography by: Gibeon Photography



○ MAR-N-SW-OF + MAR-B-SW-OF ☉ ⚡ MAR-N-xx-OF + MAR-B-xx-OF ☉

CE  Massachusetts Code
cUPC listing by IAPMO

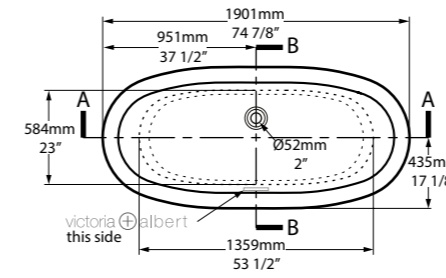

Top View

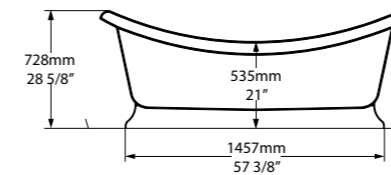

Side View

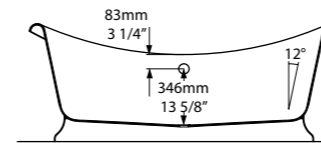

Section AA

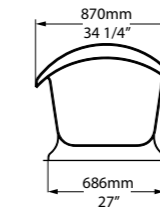

Front View

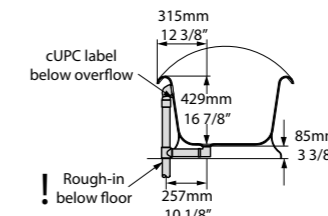

Section BB

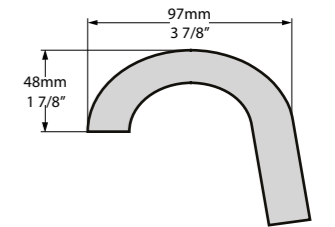
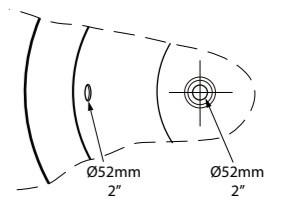

Rim Detail

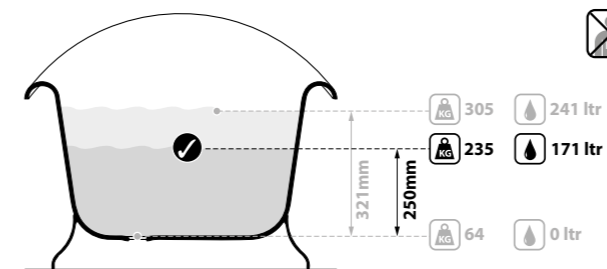

SW  rich in Volcanic Limestone  AN BK GR MB MW SG



Ajoutez une touche de sophistication instantanée à n'importe quelle salle de bains - une élégance minimaliste qui descend gracieusement jusqu'au sol. Dispose d'un vide sanitaire pour le raccordement du système d'évacuation. Disponible en sept couleurs.

Perfektionieren Sie jedes Badezimmer im Nu: Minimalistische Eleganz bis auf den Boden. Mit einem unten liegenden Hohlraum für die Abflussrohre. Erhältlich in 7 Außenfarben.

In un'istante rende sofisticata qualsiasi stanza da bagno. Eleganza minimalista nella forma di una gettata unica che scende con grazia sul pavimento. Disponibile in sette finiture di colore.

Voegt een verfijnde touch toe aan alle badkamers - minimalistische elegantie uit één enkel stuk gegoten tot op de vloer met dubbele bodem voor eenvoudige en verborgen leiding werk. Verkrijgbaar in zeven kleurafwerkingen.

Collections connexes / Entsprechendes Zubehör / Collezioni correlate / Gerelateerde collecties

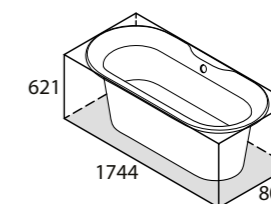
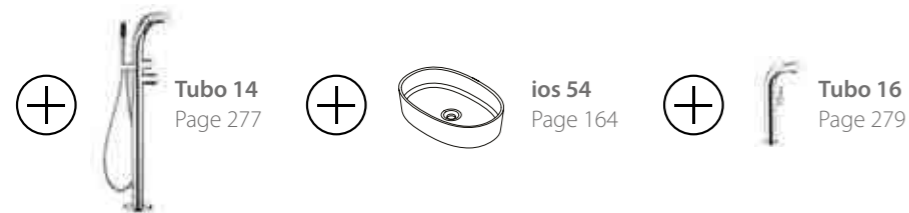

○ MON-N-SW-OF
 ■ MON-N-xx-OF
 64Kg

Dawn Topham – Monaco



Madikwe Hills Private Game Lodge, South Africa

Photography by: Vanessa Lewis



Monaco

○ MON-N-SW-OF ◻ ⚡ MON-N-xx-OF ◻

CE UPC
 Massachusetts Code
 cUPC listing by IAPMO

Tap holes can be drilled by installer
 Armaturenlöcher können leicht vom Installateur gebohrt werden
 Les trous de robinetterie peuvent être percés par l'installateur
 Pueden ser perforados por el instalador
 I fori per rubinetti possono essere perforati dall'installatore

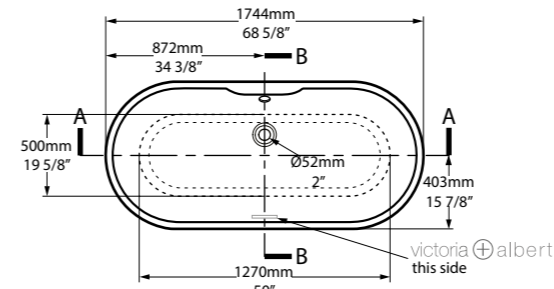

Top View

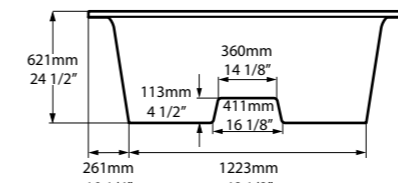

Side View

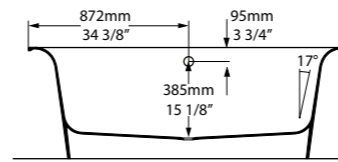

Section AA

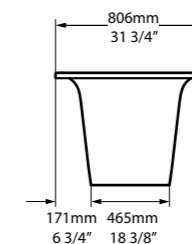

Front View

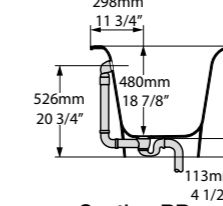

Section BB

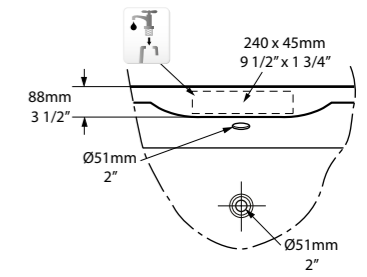

Rim Detail

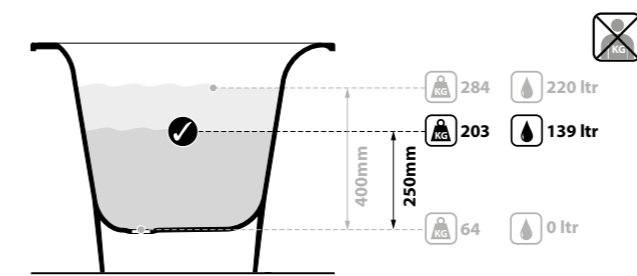

220 ltr
 139 ltr
 0 ltr



- SW
- QC rich in Volcanic Limestone
- AN
- BK
- GR
- MB
- MW
- SG

Une magnifique baignoire en îlot sans rebord, de faible hauteur et dotée de courbes subtiles. Compacte et conçue avec un design ergonomique, la baignoire assure une forte présence architecturale dans les plus petites salles de bains. Egalement disponible dans un plus grand format, appelé Mozzano 2. Disponible en sept couleurs.

Mozzano ist eine wunderbar verarbeitete Wanne, randlos und freistehend, mit niedriger Einstiegshöhe und schlichten Formen. Die ergonomisch gestaltete, kompakte Wanne entfaltet ihre starke Präsenz auch in kleineren Bädern. Auch lieferbar in größerem Format, unter der Bezeichnung Mozzano 2. Erhältlich in 7 Außenfarben.

Una stupenda vasca freestanding realizzata senza bordi e disegnata con curve decise dal design ergonomico. Mozzano offre un pezzo unico per spazi compatti. Disponibile anche in un formato più grande chiamato Mozzano 2. Disponibile in sette finiture di colore.

Een prachtig vormgegeven randloos vrijstaand bad, ontworpen met vertrouwde lijnen en een ergonomisch design; Mozzano levert een sterke architectonische aanwezigheid in compacte ruimtes. Ook beschikbaar in een groter formaat; Mozzano 2. Verkrijgbaar in zeven leuraferwerkingen.

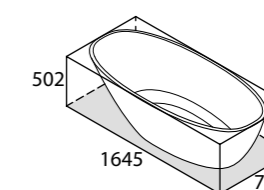

○ MOZ-N-SW-NO
 ■ MOZ-N-xx-NO
 65Kg

Collections connexes / Entsprechendes Zubehör / Collezioni correlate / Gerelateerde collecties





Espírito Santo, Brazil

Photography by: Felipe Araújo



○ MOZ-N-SW-NO  ♣ MOZ-N-xx-NO 

  Massachusetts Code
cUPC listing by IAPMO

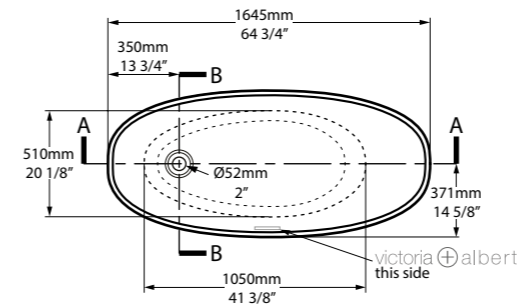

Top View

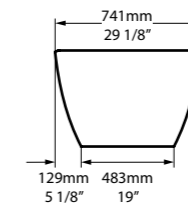

Front View

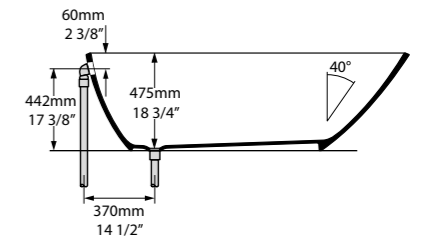

Section AA

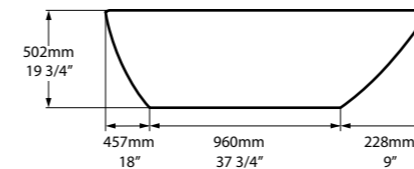

Side View

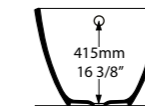

Section BB

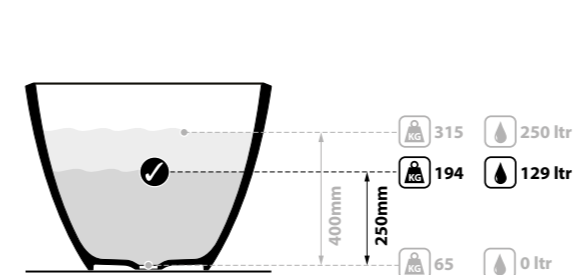

SW  rich in Volcanic Limestone  AN  BK  GR  MB  MW  SG



NEW Mozzano 2

○ MO2-N-SW-NO □ MO2-N-xx-NO

CE UPC Massachusetts Code cUPC listing by IAPMO

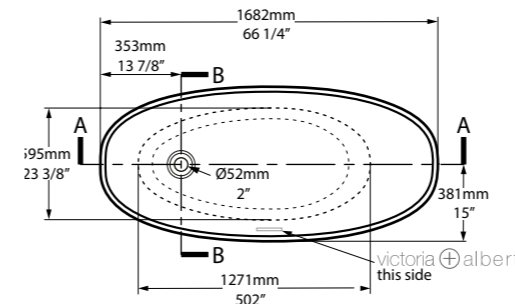

Top View

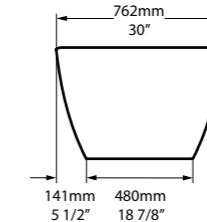

Front View

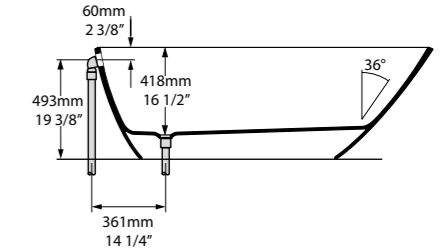

Section AA

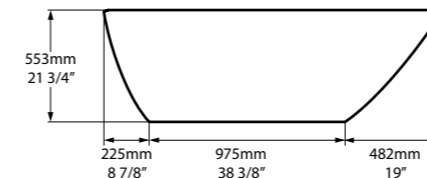

Side View

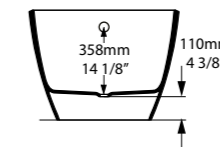

Section BB

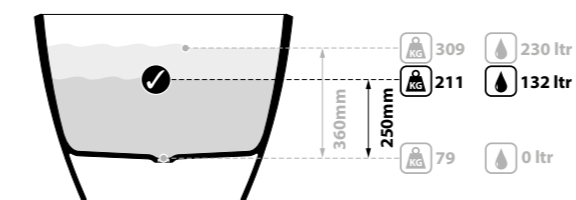

Mozzano 2 suit le même design que la baignoire Mozzano mais avec des dimensions plus grandes. Dispose d'un vide sanitaire pour le raccordement du système d'évacuation. Disponible en sept couleurs.

Mozzano 2 volgt het zelfde design als het Mozzano bad, maar is langer en hoger. Het heeft daarentegen een dubbele bodem, voor eenvoudige installatie van leidingwerk. Verkrijgbaar in zeven kleurenafwerkingen.

Mozzano 2 folgt dem gleichen Design wie die Mozzano Wanne, hat jedoch kompaktere Maße. Zudem besitzt sie einen unten liegenden Hohlraum für die Abflussrohre. Erhältlich in 7 Außenfarben.

Mozzano 2 offre lo stesso design della vasca Mozzano ma in dimensioni piu' grande. Caratterizzata da un vuoto sotto per l'impianto idraulico. Disponibile in sette diverse finiture.

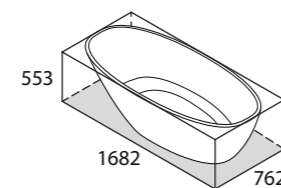

○ MO2-N-SW-NO
 □ MO2-N-xx-NO
 79Kg

- SW
- QC rich in Volcanic Limestone
- AN
- BK
- GR
- MB
- MW
- SG



En forme de coquille, la baignoire Napoli, se caractérise par un design audacieux et un profil bas, et apporte une vraie touche architecturale à une salle de bains moderne. A associer à la vasque Napoli 57 (page 170). Disponible en sept couleurs.

Mit dem ausgefallenen Design gleich einer niedrig geformten Schale wird die Napoli Wanne zum dramatischen, architektonischen Mittelpunkt jedes modernen Badezimmers. Zu kombinieren mit dem Napoli 57 Waschbecken (Seite 170). Erhältlich in 7 Außenfarben.

Di forma e struttura uniche, la vasca Napoli offre la semplicità di una vasca senza bordi con facilità di accesso, senza però perdere il comfort di una vasca lussuosa. Complementata dal lavabo Napoli 57 (pagina 170).

Vervaardigd als een half ei, voegt de Napoli een teatrale en architectonische glamour aan de moderne badkamer toe. Aangevuld met de Napoli 57 wasbak (pg 170). Verkrijgbaar in zeven kleurafwerkingen.

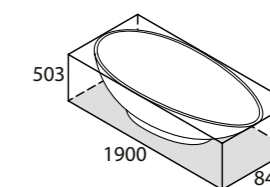

○ NAP-N-SW-NO
 ■ NAP-N-xx-NO
 68Kg

Collections connexes / Entsprechendes Zubehör / Collezioni correlate / Gerelateerde collecties

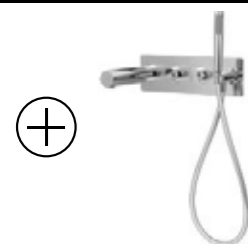

Tubo 21
Page 285



Napoli 57
Page 170

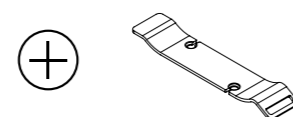

Tombolo 10
Page 310



Tubo 16
Page 279

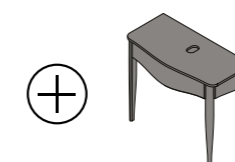

Lavello 114 Glass
Page 220



London, United Kingdom

Photography by: Darren Chung © Homes & Gardens



○ NAP-N-SW-NO  † NAP-N-xx-NO 

CE  Massachusetts Code
cUPC listing by IAPMO

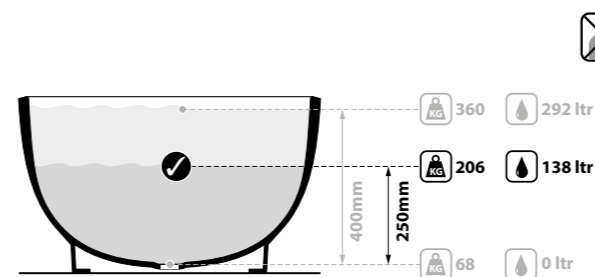
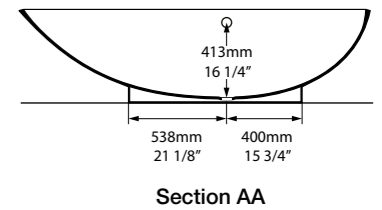
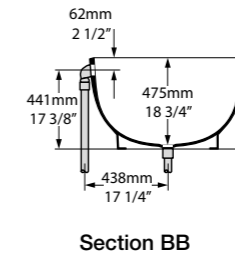
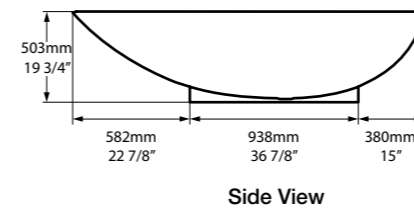
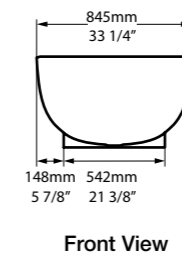
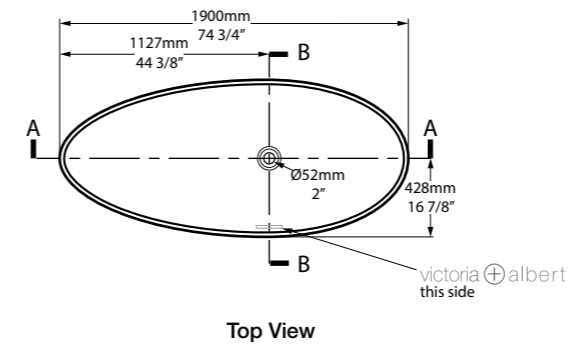

SW  rich in Volcanic Limestone™  AN  BK  GR  MB  MW  SG

Pembroke

Baptisée d'après le lieu de naissance du premier roi de la dynastie Tudor d'Angleterre, la baignoire Pembroke évoque une élégance royale, accentuée par des coins nets et des rebords précis. Profonde et à double assise, la baignoire offre une luxueuse expérience du bain. Dispose d'un vide sanitaire pour le raccordement du système d'évacuation. Conçue par Meneghello Paoletti Associati. A associer à la vasque Pembroke 52 (page 184). Disponible en sept couleurs.

Die Wanne Pembroke wurde benannt nach dem Geburtsort des ersten englischen Tudor-Königs. Sie strahlt einen royalen Anspruch aus, besticht durch klare Ecken und einen eleganten Rand. Dank ihrer Tiefe und dem doppelten Ende bietet diese Wanne ein sehr luxuriöses Baderlebnis. Mit einem unten liegenden Hohlraum für die Abflussrohre. Entworfen vom Designstudio Meneghello Paoletti Associati. Erhältlich in 7 Außenfarben. Zu kombinieren mit dem Pembroke 52 Waschbecken (Seite 184).

La vasca Pembroke prende il nome dal luogo di nascita del primo Re Tudor d'Inghilterra ed evoca un'eleganza regale, accentuata da angoli netti ed un bordo pulito. Profonda e a doppia seduta, la vasca da bagno regala una lussuosa esperienza. Progettato da Meneghello Paoletti Associati. Disponibile in sette finiture di colore. Complementata dal lavabo Pembroke 52 (Pagina 184).

Vernoemd naar de geboorteplaats van Engeland's eerste Tudor koning, heeft de Pembroke een vorstelijke elegantie, geaccentueerd door scherpe hoeken en een nette rand. Het bad is diep en dubbelzijdig voor een luxe badervaring en tevens een dubbele bodem voor eenvoudige installatie van leiding werk. Ontworpen door Meneghello Paoletti Associati. Verkrijgbaar in zeven kleurafwerkingen. Aangevuld met de Pembroke 52 wasbak (pg 184).

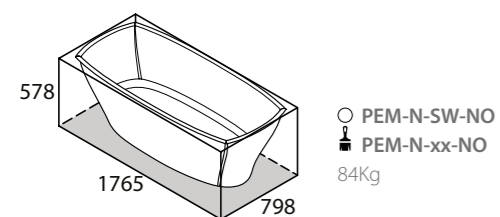

Collections connexes / Entsprechendes Zubehör / Collezioni correlate / Gerelateerde collecties



Florin 20
Page 248



Florin 26
Page 249



○ PEM-N-SW-NO ↓ PEM-N-xx-NO

CE Massachusetts Code
cUPC listing by IAPMO

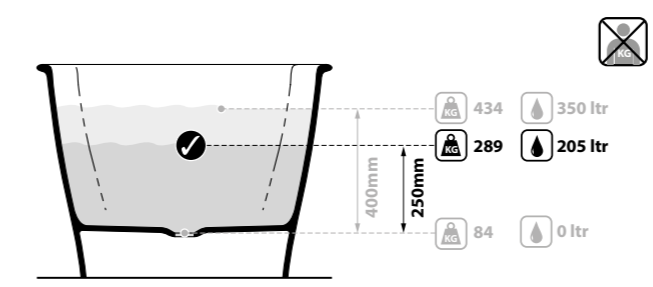
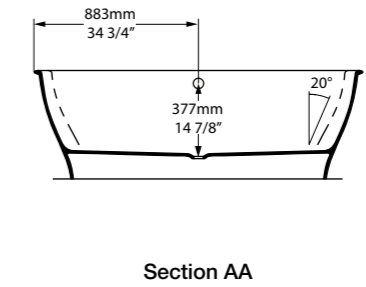
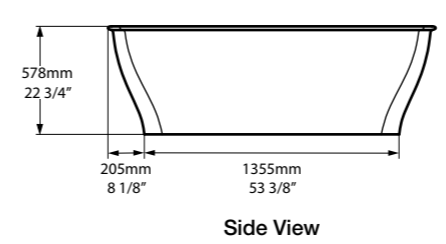
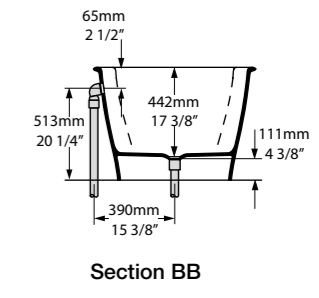
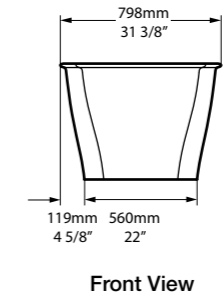
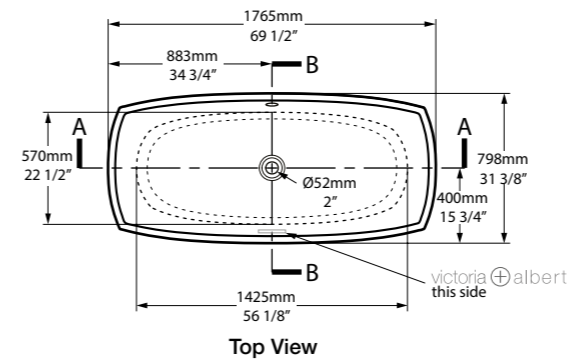

SW rich in Volcanic Limestone AN BK GR MB MW SG

Pescadero

Inspirée par la mer, la baignoire à double assise Pescadero aux rebords ondulants, a été conçue pour former une « vague » caractéristique et asymétrique. Dispose d'un vide sanitaire pour le raccordement du système d'évacuation. Disponible en sept couleurs.

Inspiriert vom Meer besitzt die doppelseitige Wanne Pescadero einen wellenförmigen Rand gleich einer asymmetrischen Woge. Mit einem unten liegenden Hohlraum für die Abflussrohre. Erhältlich in 7 Außenfarben.

Ispirato al mare, il Pescadero a doppia seduta è dotato di un'orlo ondulato, progettato per formare una distinta e asimmetrica 'onda'. Disponibile in sette finiture di colore.

Geïnspireerd door de zee, beschikt de dubbelzijdige Pescadero over een golvende rand, ontworpen om een onderscheidende, asymmetrische 'wave' te vormen. Beschikt over een dubbele bodem voor eenvoudige installatie van leidingwerk. Verkrijgbaar in zeven kleurafwerkingen.

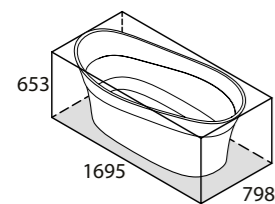

○ PES-N-SW-NO
 ■ PES-N-xx-NO
 77Kg

Collections connexes / Entsprechendes Zubehör / Collezioni correlate / Gerelateerde collecties





○ PES-N-SW-NO  ↓ PES-N-xx-NO 

  Massachusetts Code
cUPC listing by IAPMO
Registered Design

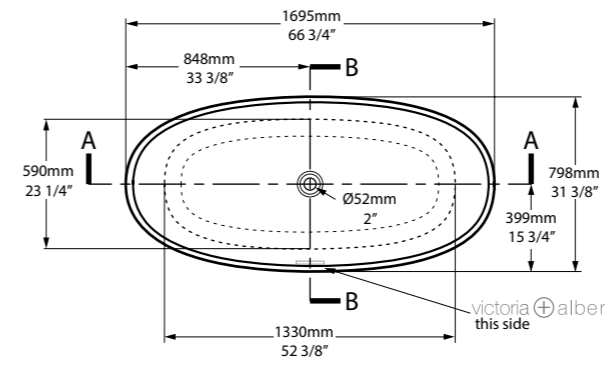

Top View

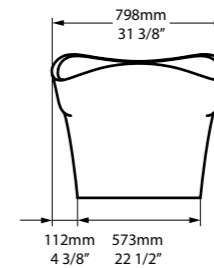

Front View

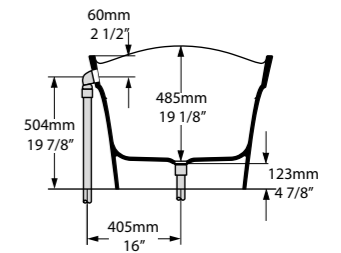

Section BB

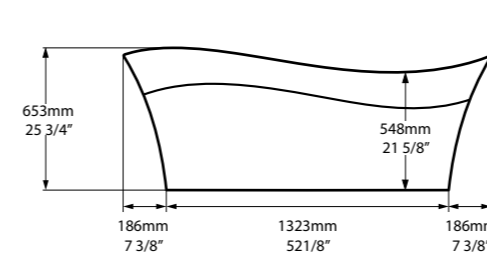

Side View

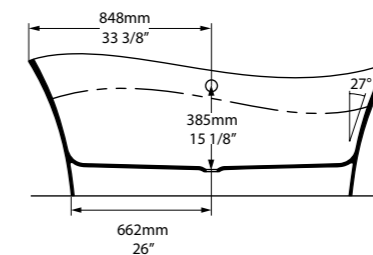

Section AA

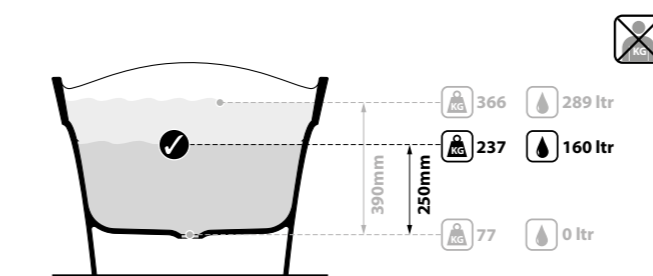
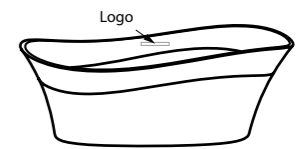

SW  rich in Volcanic Limestone  AN     



Une baignoire en îlot opulente à rebords arrondis et à double assise qui offre une symétrie classique. Un élément central de la pièce. S'associe parfaitement à la vasque Radford 51 (page 172). Disponible en sept couleurs. Une gamme de finitions pour pieds en métal est disponible - voir page suivante.

Die opulente, freistehende Wanne bietet klassische Symmetrie. Sie ist beidseitig nutzbar und besticht mit einem ausladenden, elegant verarbeiteten Rand. Zu kombinieren mit dem Radford 51 Waschbecken (Seite 172). Erhältlich in 7 Außenfarben. Eine Auflistung der verfügbaren Metalloberflächen für die FüÙe finden Sie auf der nächsten Seite.

Una ricca vasca freestanding a doppia seduta con dettaglio elegante sul bordo, offre una simmetria classica. Un vero pezzo da esposizione. Complementata perfettamente dal lavabo Radford 51 (pagina 172). Disponibile in sette finiture di colore. È disponibile una gamma di finiture per piedini in metallo - vedi nella pagina seguente.

Een weelderig dubbelzijdig roll-top vrijstaand bad met elegante rand detaillering, waarbij klassieke symmetrie. Een echt kunststuk. Perfect aangevuld door de Radford 51 wasbak (pg 172). Verkrijgbaar in zeven kleurafwerkingen. Een gamma van afwerkingen van metaal poten zijn beschikbaar (zie volgende blz).

Collections connexes / Entsprechendes Zubehör / Collezioni correlate / Gerelateerde collecties

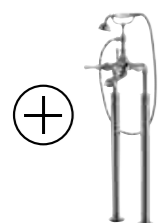
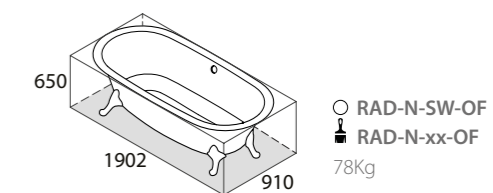

Staffordshire 26
Page 271

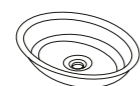

Radford 51
Page 172



Staffordshire 11
Page 267



○ RAD-N-SW-OF  ↓ RAD-N-xx-OF 

CE  Massachusetts Code
cUPC listing by IAPMO
Registered Design

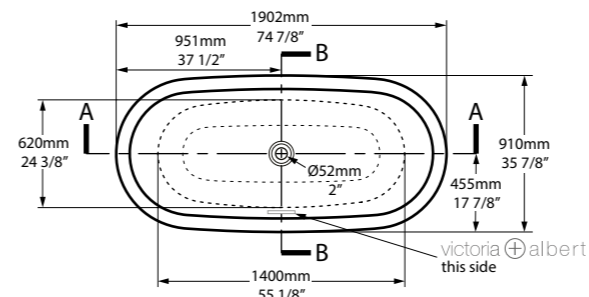

Top View

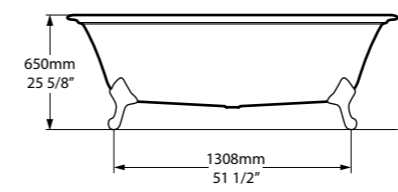

Side View

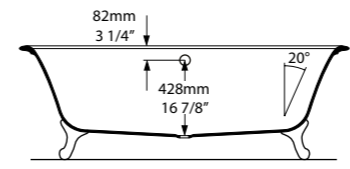

Section AA

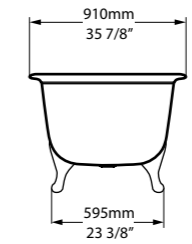

Front View

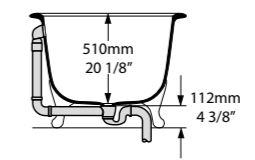

Section BB

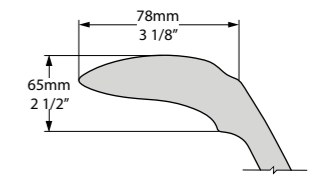

Rim Detail

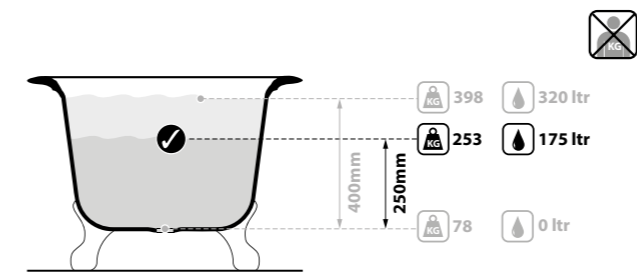

Qc rich in Volcanic Limestone™

-  FT-RAD-SW
-  FT-RAD-WH
-  FT-RAD-PC
-  FT-RAD-PB
-  FT-RAD-PN
-  FT-RAD-BN
-  FT-RAD-AB

SW  rich in Volcanic Limestone™

-  AN
-  BK
-  GR
-  MB
-  MW
-  SG



La baignoire Ravello allie lignes sobres et franches à des courbes plus douces. Dispose d'un vide sanitaire pour le raccordement du système d'évacuation. A associer à la vasque Ravello 60 (page 174). Disponible en sept couleurs.

Gerade Linien verbinden sich mühelos mit sanften Kurven. Mit einem unten liegenden Hohlraum für die Abflussrohre. Zu kombinieren mit dem Ravello 60 Waschbecken (Seite 174). Erhältlich in 7 Außenfarben.

Linee audaci si combinano con curve dolci. Complementato dal lavabo Ravello 60 (pagina 174). Disponibile in sette diversi colori.

Strakke rechte lijnen combineren moeiteloos met zachte rondingen. Zijn dubbele bodem biedt eenvoudige instalatie van leidingwerk. Aangevuld met de Ravello 60 wasbak (pg 174) Verkrijgbaar in zeven kleurafwerkingen.

Collections connexes / Entsprechendes Zubehör / Collezioni correlate / Gerelateerde collecties

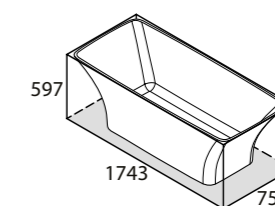

○ RAV-N-SW-NO
 ■ RAV-N-xx-NO
 85Kg



Orange County, California, USA

Photography by: Marisa Vitale



○ RAV-N-SW-NO  ↓ RAV-N-xx-NO 

CE  Massachusetts Code cUPC listing by IAPMO

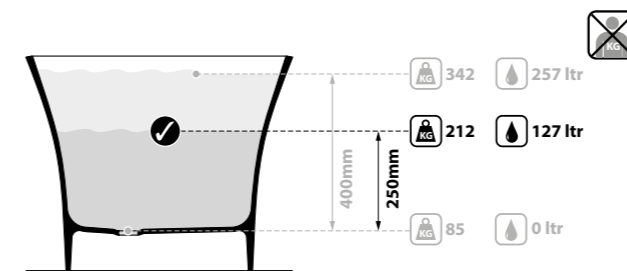
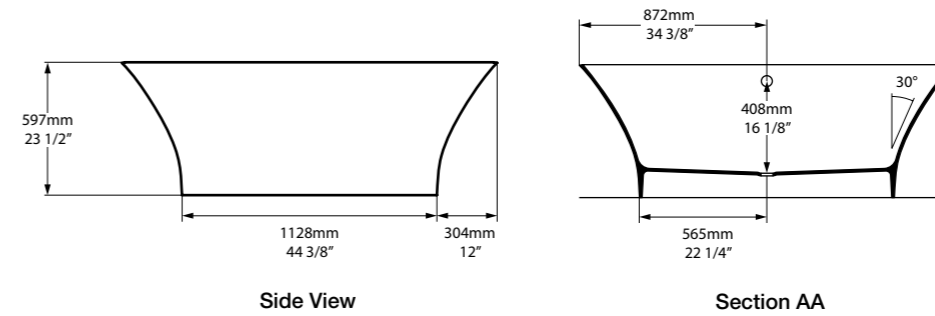
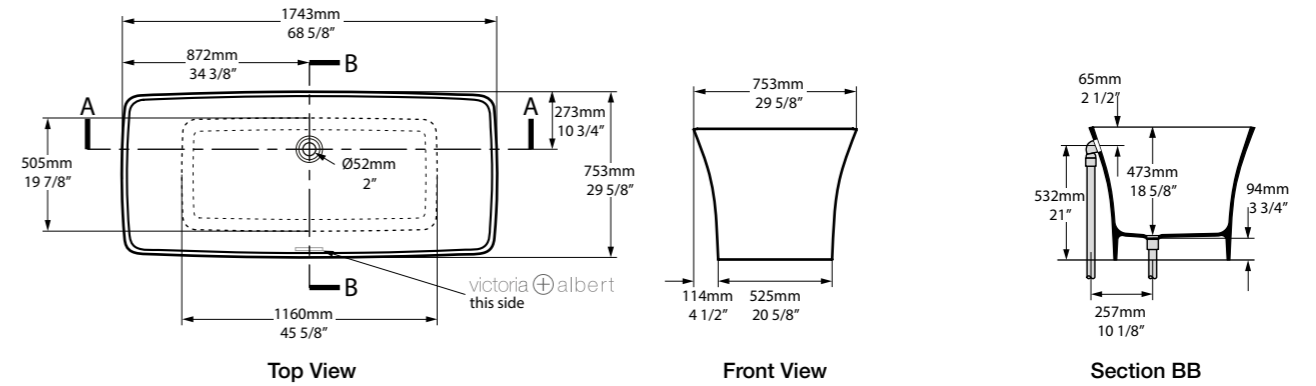

SW  rich in Volcanic Limestone   AN BK GR MB MW SG



Une baignoire à double assise élégante disposant de pieds dits "en rouleaux", caractéristiques du style Art Déco. Son design international s'intègre aussi bien dans un décor moderne que d'époque. Disponible en sept couleurs.

Eine elegante Wanne mit doppelter Rückenlehne und Art-Deco Füßen. Der internationale Stil eignet sich für moderne und zeitlose Einrichtungen. Erhältlich in 7 Außenfarben.

Questa è un'elegante vasca a doppio schienale con i piedi in stile "art deco". Il tipo di modello si adatta facilmente ad ambienti sia moderni che d'epoca. Disponibile in sette finiture di colore.

Een elegante dubbelzijdige Roll-Top bad met Art Deco poten. Internationaal gestyled past dit model zowel in moderne als eigentijdse badkamers. Verkrijgbaar in zeven kleurafwerkingen.



Qc rich in Volcanic Limestone™

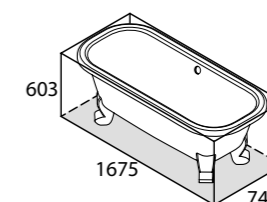

○ RIC-N-SW-OF
 ■ RIC-N-xx-OF
 60Kg

Collections connexes / Entsprechendes Zubehör / Collezioni correlate / Gerelateerde collecties

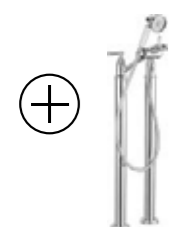

Florin 26
Page 249

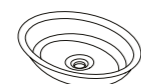

Radford 51
Page 172

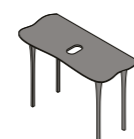

Stiletto 110 Glass
Page 230



Florin 11
Page 246



Pittsburgh, Pennsylvania, USA

Photography by: Max Kim-Bee



○ RIC-N-SW-OF ☐ ♣ RIC-N-xx-OF ☐

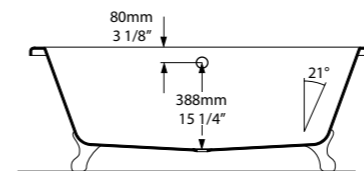
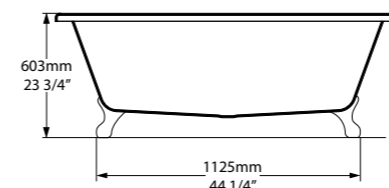
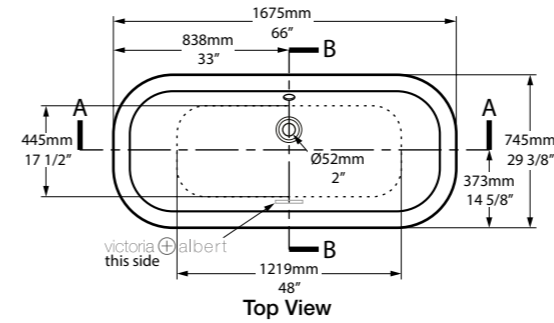

Section AA

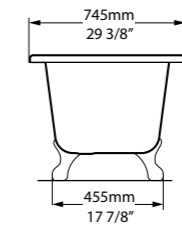

Front View

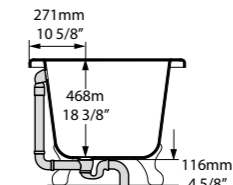

Section BB

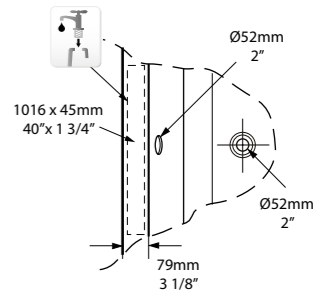

Rim Detail

CE  Massachusetts Code cUPC listing by IAPMO

 Tap holes can be drilled by installer
 Armaturenlöcher können leicht vom Installateur gebohrt werden
 Les trous de robinetterie peuvent être percés par l'installateur
 Pueden ser perforados por el instalador
 I fori per rubinetti possono essere perforati dall'installatore

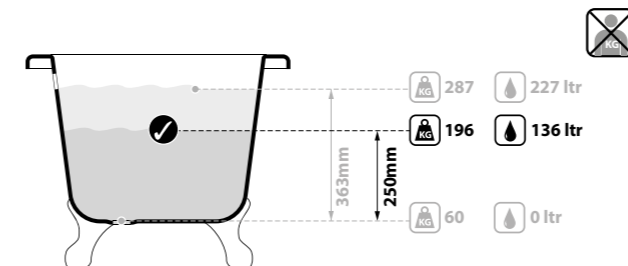

SW  rich in Volcanic Limestone™  AN BK GR MB MW SG





Plus grande que la baignoire victorienne traditionnelle, dotée, en option, de pieds style "patte de lion" ou modernes. Disponible en sept couleurs. Une gamme de finitions pour pieds en métal est disponible - voir page suivante.

Länger als die herkömmlichen viktorianischen Wannen und mit einer Auswahl an traditionellen Löwenfüßen oder modernen Varianten. Erhältlich in 7 Außenfarben. Eine Auflistung der verfügbaren Metalloberflächen für die Füße finden Sie auf der nächsten Seite.

Una vasca a schienale alto superbamente confortevole. Più lunga della vasca Vittoriana a schienale alto tradizionale, con piedi a zampe di leone o un'opzione più moderne. Disponibile in sette finiture di colore. È disponibile una gamma di finiture per piedini in metallo - vedi nella pagina seguente.

Langer dan de traditionele Victoriaanse Slipperbad, met zowel leeuwen poten also moderne poot opties. Verkrijgbaar in zeven kleurafwerkingen. Een gamma van afwerkingen van metaal poten zijn beschikbaar (zie volgende blz).

Collections connexes / Entsprechendes Zubehör / Collezioni correlate / Gerelateerde collecties

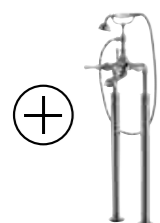

Staffordshire 26
Page 271

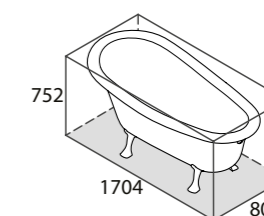

○ ROX-N-SW-OF
■ ROX-N-xx-OF
60Kg



Bona Dea Private Estate, Hermanus, South Africa



○ ROX-N-SW-OF  ⚡ ROX-N-xx-OF 

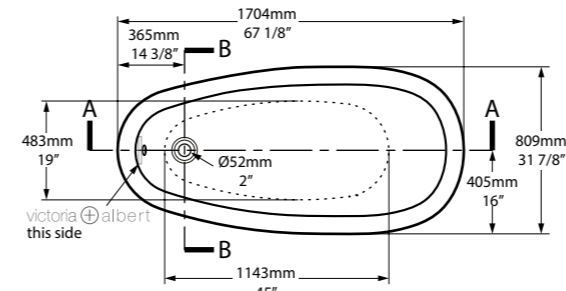

Top View

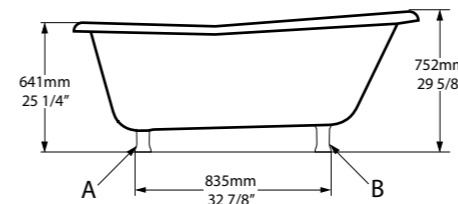

Side View

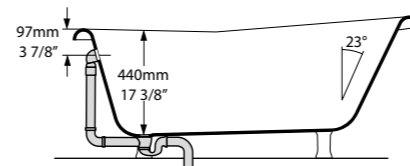

Section AA

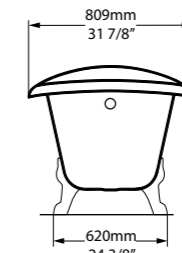

Front View

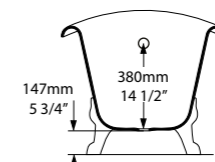

Section BB

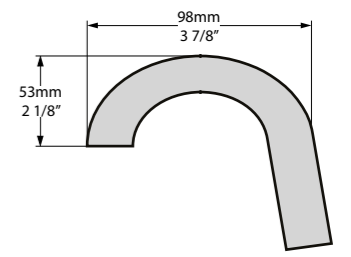
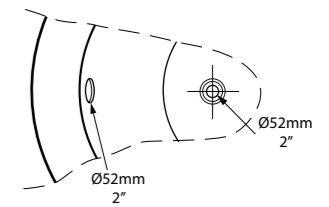

Rim Detail

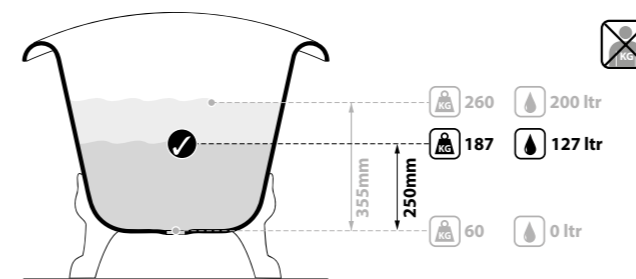

CE  Massachusetts Code cUPC listing by IAPMO



 rich in Volcanic Limestone™



Les lignes parfaites de cette baignoire au design superbe, ainsi que ses dimensions compactes, en font le choix idéal dans des salles de bain de plus petite taille. Entrez dans le monde du style Victorien authentique. Disponible en sept couleurs. Une gamme de finitions pour pieds en métal est disponible - voir page suivante.

Die perfekten Linien dieser hervorragend konzipierter Slipper Wanne und ihre kompakten Abmessungen machen sie besonders attraktiv für kleinere Bäder - Viktorianischem Stil für Ihr Badezimmer. Erhältlich in 7 Außenfarben. Eine Auflistung der verfügbaren Metalloberflächen für die FüÙe finden Sie auf der nächsten Seite.

Questa superba vasca a doppio schienale e' stata progettata con linee perfette e dimensioni compatte per renderla un perfetto gioiellino in stanze da bagno meno spaziose. Ecco come creare l'autentico stile Vittoriano per la tua casa. Disponibile in sette finiture di colore. E' disponibile una gamma di finiture per piedini in metallo - vedi nella pagina seguente.

De perfecte lijnen van dit prachtig ontworpen slipper bad en zijn compacte afmetingen maken dit model zeer geschikt voor kleinere badkamers - authentieke Victoriaanse stijl voor uw huis. Verkrijgbaar in zeven kleurafwerkingen. Een gamma van afwerkingen van metaal poten zijn beschikbaar (zie volgende blz).



Collections connexes / Entsprechendes Zubehör / Collezioni correlate / Gerelateerde collecties



Florin 15
Page 247



Florin 20
Page 248

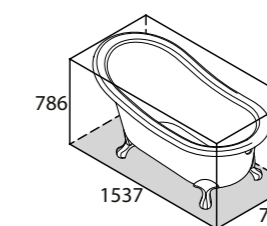

○ SHR-N-SW-OF
■ SHR-N-xx-OF
55Kg



○ SHR-N-SW-OF ☐ ↓ SHR-N-xx-OF ☐

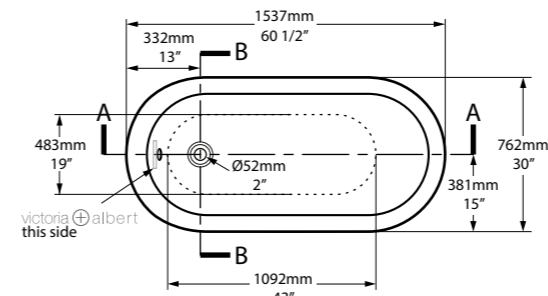

Top View

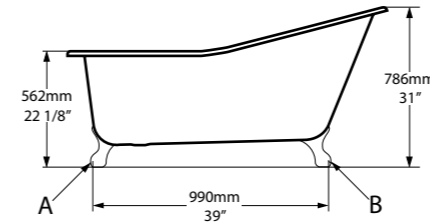

Side View

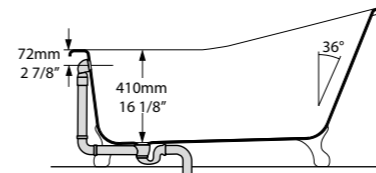

Section AA

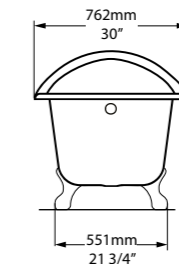

Front View

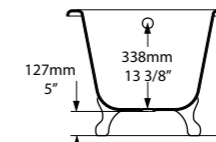

Section BB

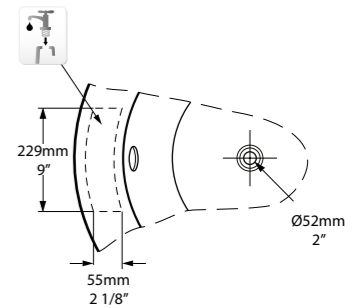

Rim Detail

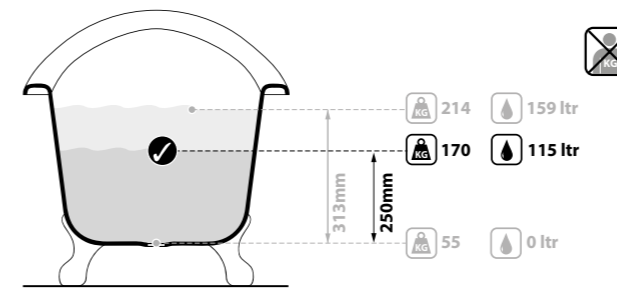
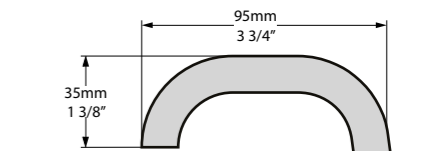

CE  Massachusetts Code cUPC listing by IAPMO

 Tap holes can be drilled by installer
 Armaturenlöcher können leicht vom Installateur gebohrt werden
 Les trous de robinetterie peuvent être percés par l'installateur
 Pueden ser perforados por el instalador
 I fori per rubinetti possono essere perforati dall'installatore



Qc rich in Volcanic Limestone™



FT-SHR-SW FT-SHR-WH FT-SHR-PC FT-SHR-PB FT-SHR-PN FT-SHR-BN





Terrassa est une baignoire à double assise avec des détails internes sculptés. Avec seulement 1702mm de long, elle s'adapte parfaitement aux salles de bains contemporaines de toute taille. Pour une version similaire disposant d'un vide sanitaire, voir la Barcelona 2. A associer aux vasques Barcelona 48, Barcelona 55 ou Barcelona 64 (page 152-157). Disponible en sept couleurs.

Die Terrassa ist eine doppelseitige Wanne mit skulpturalen Details an der Innenseite. Mit nur 1702mm Länge passt sie in moderne Badezimmer jeder Größe. Für ein ähnliches Modell mit unten liegendem Hohlraum beachten Sie bitte die Barcelona 2. Zu kombinieren mit den Waschbecken Barcelona 48, Barcelona 55 oder Barcelona 64 (Seiten 152-157). Erhältlich in 7 Außenfarben.

La Terrassa è una vasca a doppia seduta con dettagli scolpiti internamente. Con soli 1702mm di lunghezza, è la soluzione perfetta per un bagno contemporaneo di qualsiasi dimensione. Per una versione simile con lo spazio sotto, vedi Barcelona 2. Complementata dai lavabi Barcelona 48, Barcelona 55 o Barcelona 64 (pagina 152-157). Disponibile in sette finiture di colore.

De Terrassa is een bad met tweezijdige rugleuningen en aan de binnenzijde een design detail. Met zijn 1702mm lengte, is het de perfecte match voor een moderne badkamer van elke omvang. Voor een soortgelijk model met dubbelebodem zie Barcelona 2. Aangevuld met de wasbakken Barcelona 48, Barcelona 55 of Barcelona 64 (pagina 152 - 157). Verkrijgbaar in zeven kleurenafwervingen.

Collections connexes / Entsprechendes Zubehör / Collezioni correlate / Gerelateerde collecties

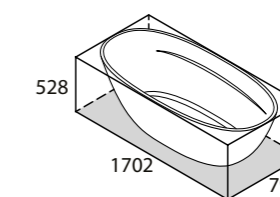

○ TER-N-SW-NO
 ■ TER-N-xx-NO
 73Kg



Tubo 14
Page 277



Tubo 20
Page 284

Design by homeowner – Terrassa

Terrassa

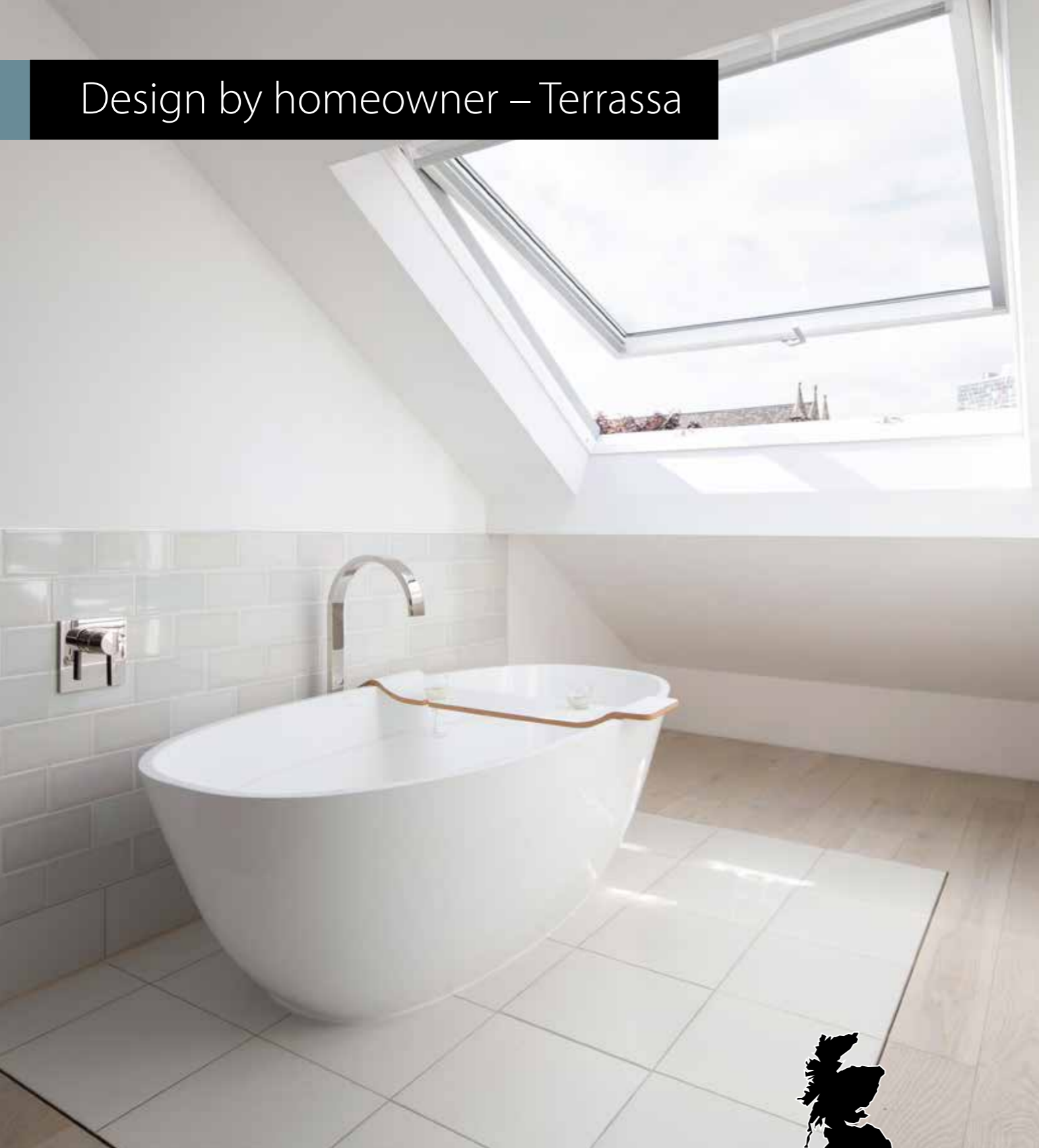

London, United Kingdom

Photography by: Agnese Sanvito



○ TER-N-SW-NO ↓ TER-N-xx-NO

Massachusetts Code
cUPC listing by IAPMO

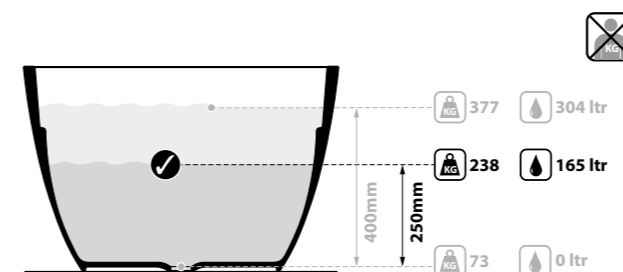
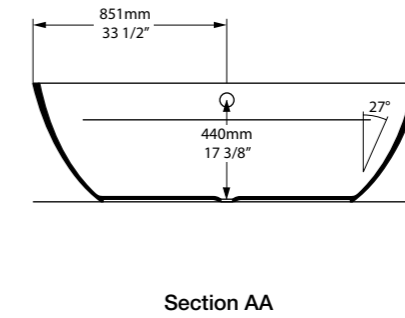
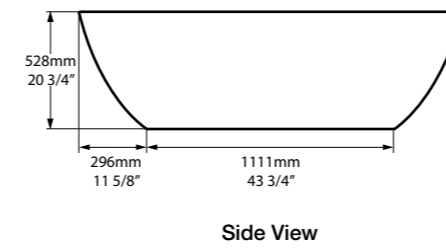
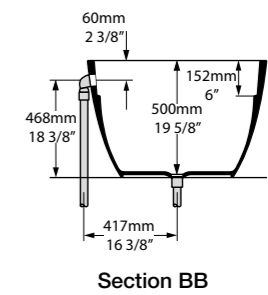
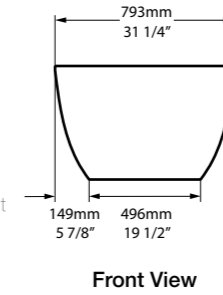
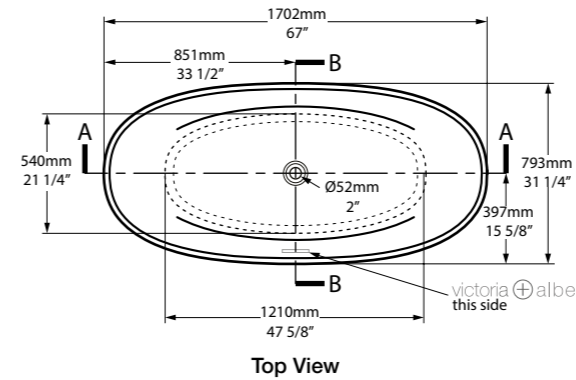

rich in Volcanic Limestone



Toulouse

Design classique de Victoria + Albert - une baignoire bateau à la profondeur généreuse s'inspirant des baignoires traditionnelles françaises des années 1860. Dispose d'un vide sanitaire pour le raccordement du système d'évacuation. Disponible en sept couleurs.

Das klassische Design von Victoria + Albert - eine Badewanne, die sich an den französischen Modellen ab 1860 orientiert. Mit einem unten liegenden Hohlraum für die Abflussrohre. Erhältlich in 7 Außenfarben.

Un nuovo design classico da Victoria + Albert - una vasca profonda a doppia seduta in stile "bateau" - ispirato alla versione francese vista per la prima volta nel 1860. Caratterizzata da uno spazio sotto per l'impianto di scarico. Disponibile in sette finiture di colore.

Nieuw klassiek design van Victoria + Albert. Een diep dubbelzijdig bad, geïnspireerd op de Franse versie, die voor het eerst gezien werd rond 1860. Beschikt over een dubbele bodem voor eenvoudige installatie van leidingwerk. Verkrijgbaar in zeven kleurafwerkingen.

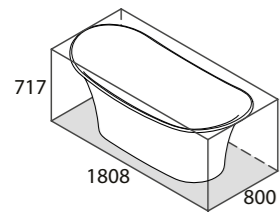

○ TOU-N-SW-NO
 ■ TOU-N-xx-NO
 88Kg

Collections connexes / Entsprechendes Zubehör / Collezioni correlate / Gerelateerde collecties

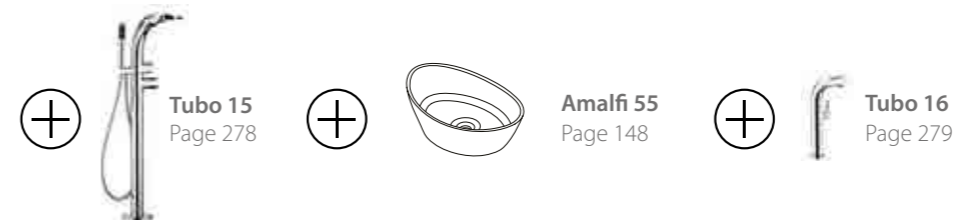

Elizabeth Roberts Design - Toulouse

Toulouse



Brooklyn, New York, USA

Photography: by Dustin Aksland



○ TOU-N-SW-NO  † TOU-N-xx-NO 

  Massachusetts Code cUPC listing by IAPMO

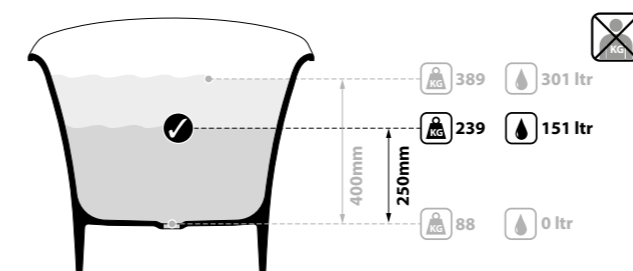
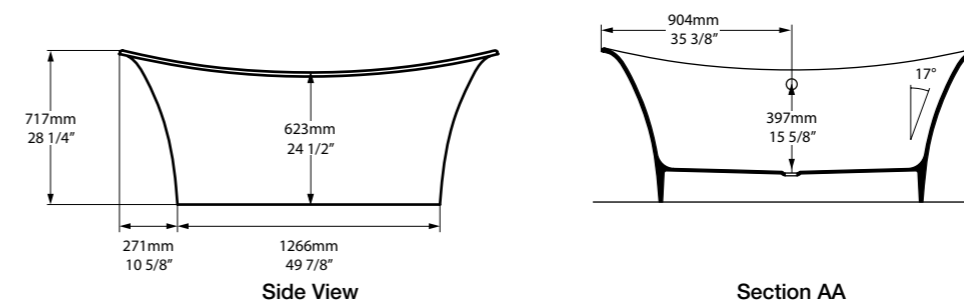
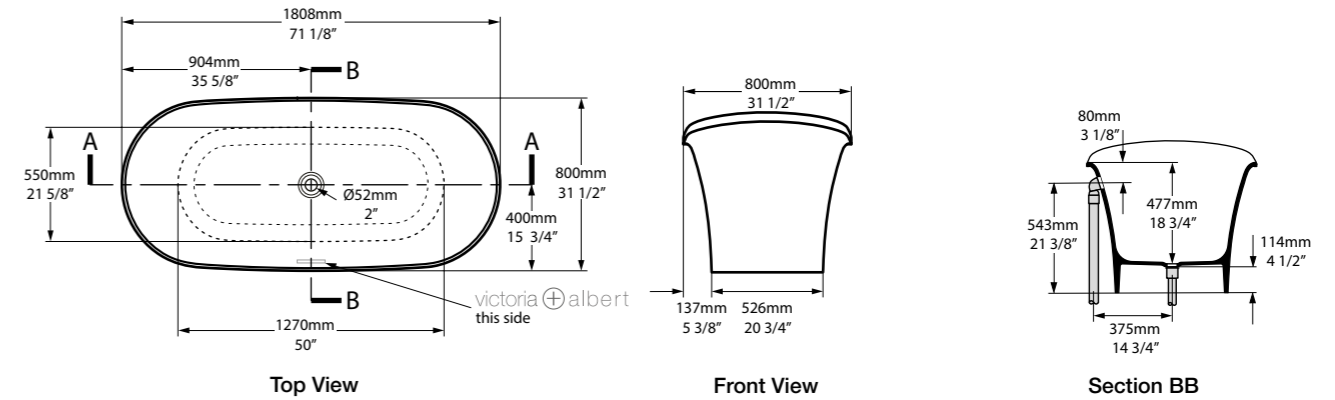

SW  rich in Volcanic Limestone  AN BK GR MB MW SG

Une réinvention moderne de la baignoire bateau classique. Profonde et à double assise, disposant d'un fin rebord, Trivento s'intègre aussi bien dans les appartements en ville que dans les salles de bains familiales. Disponible en sept couleurs.

Eine moderne Version der klassischen Bateau Wanne. Mit schmalen Rand, doppelseitig und großzügiger Eintauchtiefe ist die Trivento in kleineren Wohnungen ebenso passend wie in großen Familienbadezimmern. Erhältlich in 7 Außenfarben.

Una moderna reinvenzione della classica vasca bateau. Caratterizzata da un bel e profondo bordo a doppia seduta, Trivento è ugualmente a casa in appartamenti di città o stanze da bagno per famiglie. Disponibile in sette finiture di colore.

Een modern versie van het klassieke bateau bad. Het Trivento bad biedt diepte, een dubbele rugleuning en elegante randen. Past prima in appartementen of familie badkamers. Verkrijgbaar in zeven kleurafwerkingen.



Collections connexes / Entsprechendes Zubehör / Collezioni correlate / Gerelateerde collecties

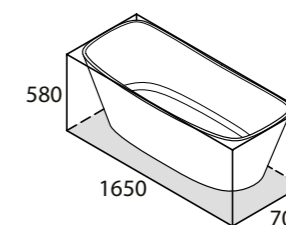

○ TRV-N-SW-NO
 ■ TRV-N-xx-NO
 68Kg



Florin 15
Page 247



Lavello 114
Page 216



Florin 9
Page 245



○ TRV-N-SW-NO  † TRV-N-xx-NO 

CE  Massachusetts Code
cUPC listing by IAPMO

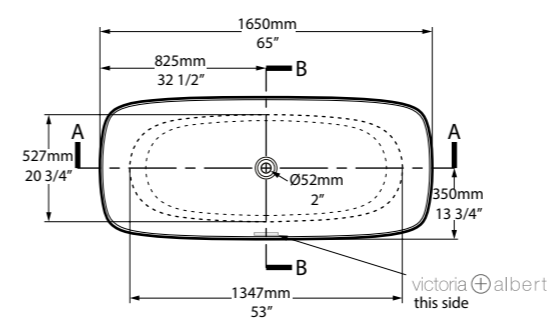

Top View

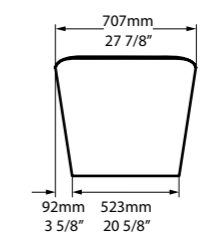

Front View

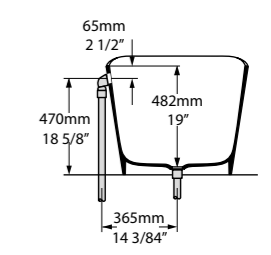

Section BB

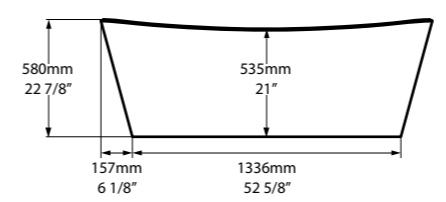

Side View

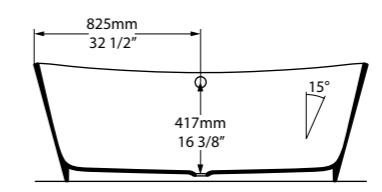

Section AA

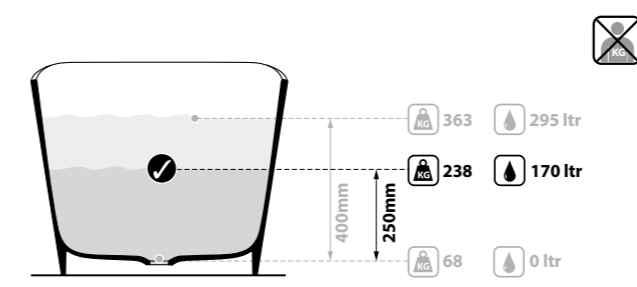

SW  rich in Volcanic Limestone™  AN  BK  GR  MB  MW  SG

Simple, profonde et à double assise - idéale pour les salles de bains modernes dans lesquelles l'espace est limité. Egalement disponible dans un plus grand format, appelé Vetralla 2. Disponible en sept couleurs.

Einfach, tief und doppelseitig, ideal für moderne Badezimmer mit begrenzten Platzverhältnissen. Auch lieferbar in größerem Format, unter der Bezeichnung Vetralla 2. Erhältlich in 7 Farboberflächen.

Semplice, profonda e a doppia seduta - ideale per stanze da bagno moderne dove lo spazio è un ptional. Disponibile anche in un formato più grande chiamato Vetralla 2. Disponibile in sette finiture di colore.

Eenvoudig, diep en dubbele rugleuning - ideaal voor moderne badkamer waar ruimte beperkt is. Ook beschikbaar in een groter formaat; Vetralla 2. Verkrijgbaar in zeven kleurafwerkingen.

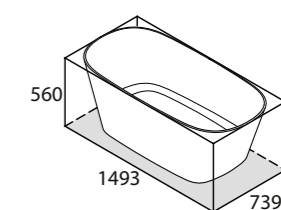

○ VET-N-SW-NO
 ■ VET-N-xx-NO
 67Kg

Collections connexes / Entsprechendes Zubehör / Collezioni correlate / Gerelateerde collecties

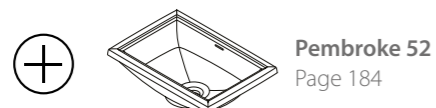



○ VET-N-SW-NO ♣ VET-N-xx-NO

CE Massachusetts Code cUPC listing by IAPMO

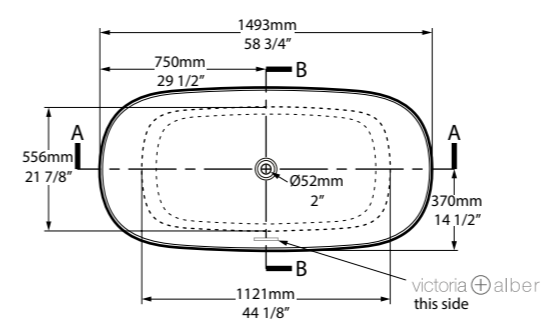

Top View

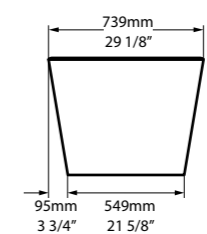

Front View

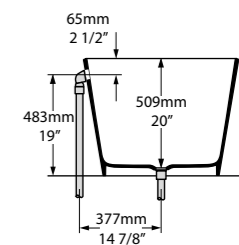

Section BB

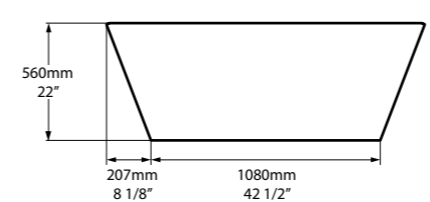

Side View

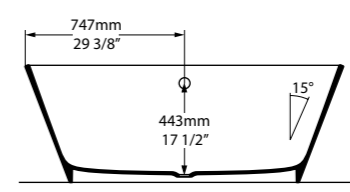

Section AA

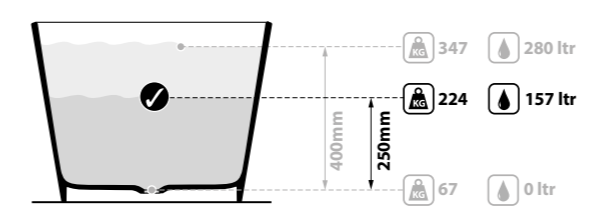

-
- rich in Volcanic Limestone™
-
-
-
-
-
-
-



Vetralla 2

○ VE2-N-SW-NO  ♣ VE2-N-xx-NO 

CE  Massachusetts Code cUPC listing by IAPMO

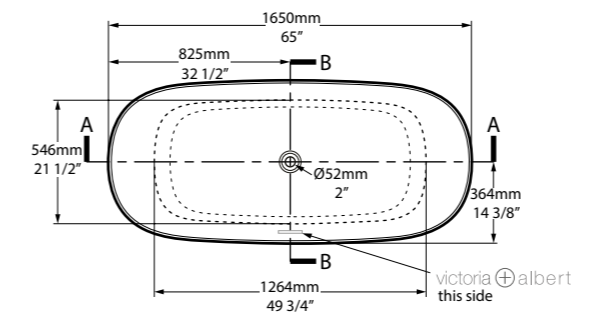

Top View

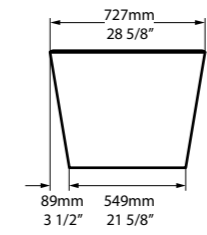

Front View

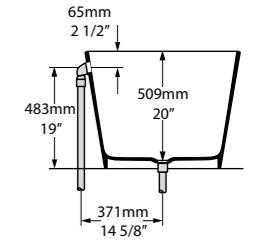

Section BB

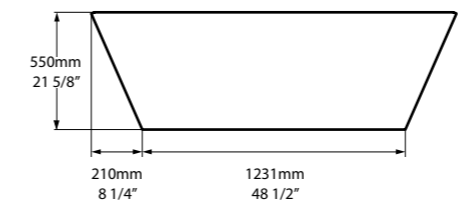

Side View

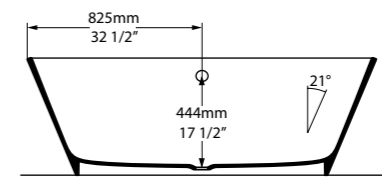

Section AA

Une baignoire moderne pour une salle de bains moderne. Vetralla 2, profonde et à double assise, est dotée de généreux volumes. Egalement disponible dans un plus petit format, appelé Vetralla. Disponible en sept couleurs.

Een modern bad voor de moderne badkamer. Vetralla 2 is diep, ruim en met dubbele rugleuning. Ook beschikbaar in kleiner formaat; Vetralla. Verkrijgbaar in zeven kleurafwerkingen.

Eine moderne Wanne für moderne Badezimmer. Die Vetralla 2 ist tief, doppelseitig und großzügigem Volumen. Auch lieferbar in kleinerem Format, unter der Bezeichnung Vetralla. Erhältlich in 7 Farboberflächen.

Una vasca moderna per una stanza da bagno moderna. Vetralla 2 è profonda e a doppia seduta dal volume generoso. Disponibile anche in un formato più piccolo chiamato Vetralla. Disponibile in sette finiture di colore.

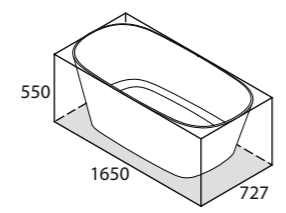

○ VE2-N-SW-NO
♣ VE2-N-xx-NO
70Kg

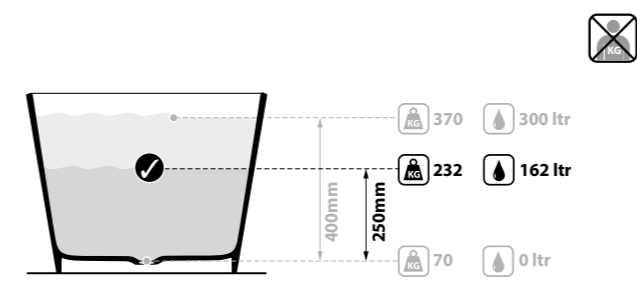

SW  rich in Volcanic Limestone   AN  BK  GR  MB  MW  SG

La baignoire Warndon, avec ses rebords côtelés classiques, reprend les détails que l'on trouvait déjà dans le travail de la pierre classique. Cette baignoire mélange design classique avec des lignes modernes et élégantes. Dispose d'un vide sanitaire pour le raccordement du système d'évacuation. Disponible en sept couleurs.

Die Warndon besitzt einen klassisch geriffelten Rand, der originale Details von Steinmetzarbeiten aufgreift. Diese Wanne verbindet klassische Merkmale mit eleganten, modernen Linien. Mit einem unten liegenden Hohlraum für die Abflussrohre. Erhältlich in 7 Außenfarben.

La Warndon presenta un bordo a coste in stile classico, adottando i dettagli originariamente trovati in muratura classica. Questa vasca fonde elementi classici con linee eleganti e moderne. Caratterizzata da uno spazio sotto per l'impianto di scarico. Disponibile in sette finiture di colore.

De Warndon is voorzien van een klassiek geribbelde rand, welke zijn oorsprong vindt in klassieke metselwerk. Dit bad combineert klassieke elementen met elegante, moderne lijnen. Beschikt over een dubbele bodem voor eenvoudige installatie van leidingwerk. Verkrijgbaar in zeven kleurafwerkingen.

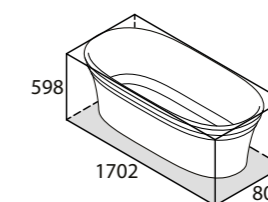

○ WAR-N-SW-NO
 ■ WAR-N-xx-NO
 86Kg

Collections connexes / Entsprechendes Zubehör / Collezioni correlate / Gerelateerde collecties

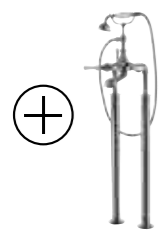

Staffordshire 26
 Page 271



London, United Kingdom

Photography by: Megan Taylor

○ WAR-N-SW-NO  ⚠ WAR-N-xx-NO 

CE  Massachusetts Code
cUPC listing by IAPMO

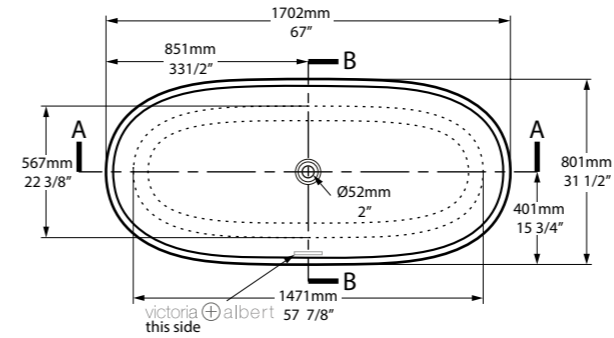

Top View

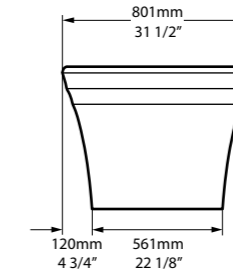

Front View

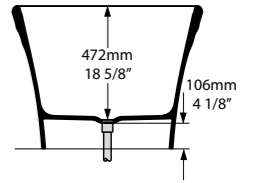

Section BB

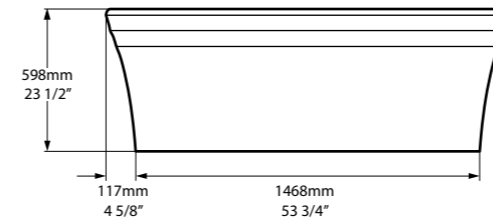

Side View



Section AA

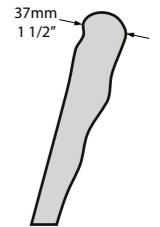

Rim Detail

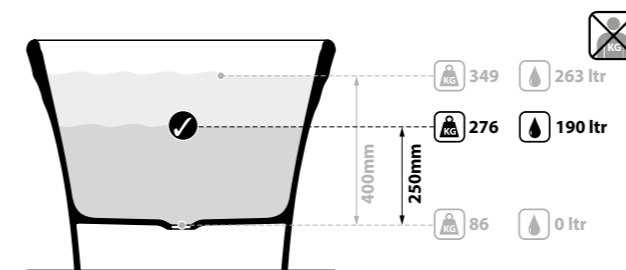

SW  rich in Volcanic Limestone  AN  BK  GR  MB  MW  SG



Avec ses lignes classiques aux dimensions plus réduites, cette baignoire à l'élégance Edwardienne exquise est parfaite dans presque tous les décors. Disponible en sept couleurs. Une gamme de finitions pour pieds en métal est disponible - voir page suivante

Mit klassischen Linien und abgespeckte Maßen. Der hervorragende Edwardianische Stil passt fast überall. Erhältlich in 7 Außenfarben. Eine Auflistung der verfügbaren Metalloberflächen für die Füße finden Sie auf der nächsten Seite.

Caratterizzata da linee classiche di dimensioni rimpicciolate. Uno stile Edwardiano squisito che si adatta ovunque. Disponibile in sette finiture di colore. E' disponibile una gamma di finiture per piedini in metallo - vedi nella pagina seguente.

Klassieke lijnen en afgeslankte afmetingen. Exquisite Edwardian stijl die vrijwel overal past. Verkrijgbaar in zeven kleurafwerkingen. Een gamma van afwerkingen van metaal poten zijn beschikbaar (zie volgende blz).

Collections connexes / Entsprechendes Zubehör / Collezioni correlate / Gerelateerde collecties

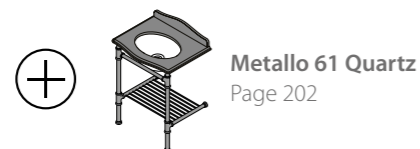
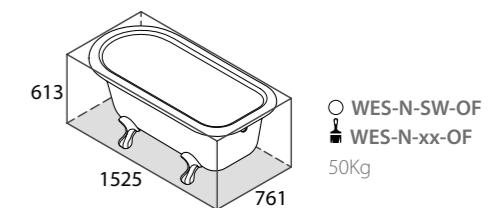



Melbourne, Australia



Photography by: Estate Imagery



FT-HAM-SW FT-HAM-WH FT-HAM-PC FT-HAM-PB FT-HAM-PN FT-HAM-BN

○ WES-N-SW-OF ◻ ↓ WES-N-xx-OF ◻

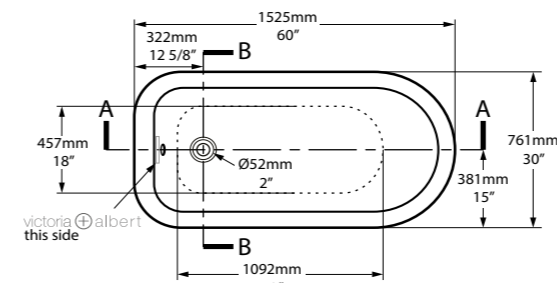

Top View

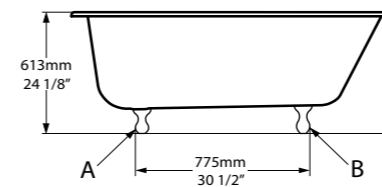

Side View

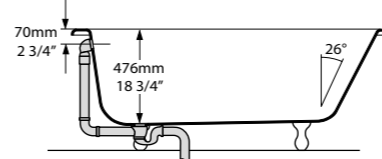

Section AA

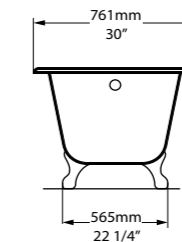

Front View

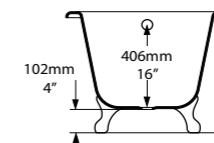

Section BB



Tap holes can be drilled by installer
 Armaturenlöcher können leicht vom Installateur gebohrt werden
 Les trous de robinetterie peuvent être percés par l'installateur
 Pueden ser perforados por el instalador
 I fori per rubinetti possono essere perforati dall'installatore

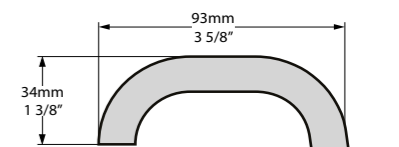
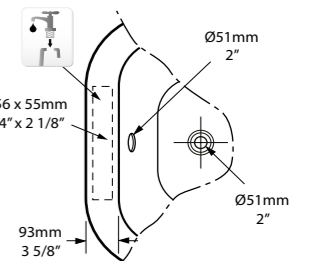

Rim Detail

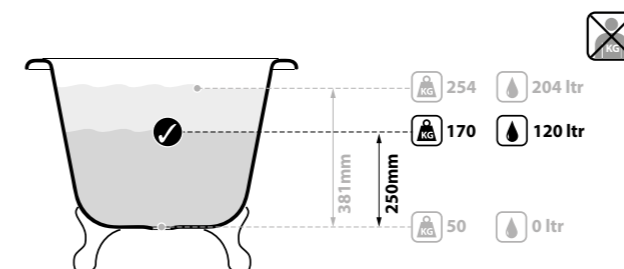

Élégante, classique et raffinée. La Worcester tire son nom de la ville anglaise réputée pour sa cathédrale et de la ville sud-africaine où se trouve l'usine Victoria + Albert. Avec son socle côtelé classique et la finition de ses rebords qui trouvent leur origine dans le travail de la pierre, elle incarne une histoire riche adaptée à de nombreux intérieurs. Dispose d'un vide sanitaire pour le raccordement du système d'évacuation. Disponible en sept couleurs.

Elegant, klassisch und kultiviert: Namensgeber der Worcester Wanne ist die alte, englische Stadt mit der berühmten Kathedrale sowie die südafrikanischen Stadt, in der die Victoria + Albert Manufaktur sitzt. Mit dem geriffelten Sockel und den klassischen Steinmetzarbeiten nachempfundenen Randdetails verkörpert sie historische Pracht, die sich in unterschiedliche Raumgestaltungen einfügt. Mit einem unten liegenden Hohlraum für die Abflussrohre. Erhältlich in 7 Außenfarben.

Elegante, classica e raffinata. La vasca Worcester prende il nome sia dall'antica cattedrale Inglese sia dalla città sudafricana dove è situato lo stabilimento di Victoria + Albert. Dotata di una base a coste in stile classico e dettagli del bordo presenti originariamente nei lavori in muratura, sposa una storia molto ricca che si adatta facilmente a diversi ambienti. Disponibile in sette finiture di colore.

Elegant, klassiek en verfijnd. De Worcester ontleent zijn naam aan de oude Zuid-Afrikaanse stad met haar beroemde cathedraal waar de Victoria + Albert fabriek gevestigd is. Met een klassiek geribbelde plint en een rand detaillering omvat het een rijke geschiedenis, geschikt voor vele interieurs. Beschikt over een dubbele bodem voor eenvoudige installatie van leidingwerk. Verkrijgbaar in zeven kleurafwerkingen.

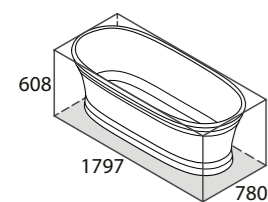

○ WOR-N-SW-NO
 ■ WOR-N-xx-NO
 92Kg



Collections connexes / Entsprechendes Zubehör / Collezioni correlate / Gerelateerde collecties



Florin 15
 Page 247

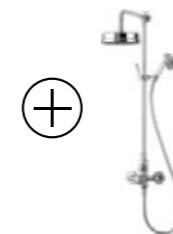

Florin 20
 Page 248



Sydney, New South Wales, Australia

Photography by: Maree Homer



○ WOR-N-SW-NO ☑ ⚡ WOR-N-xx-NO ☑

CE UPC
 cUPC listing by IAPMO

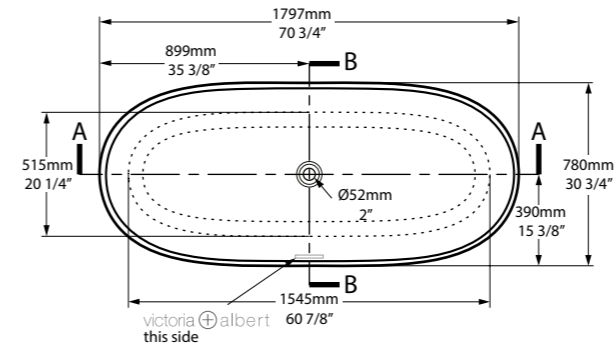

Top View

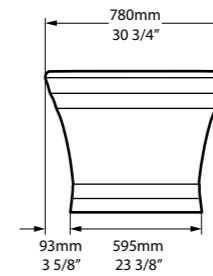

Front View

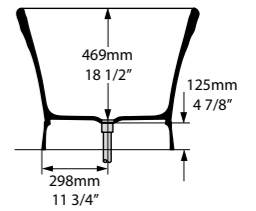

Section BB

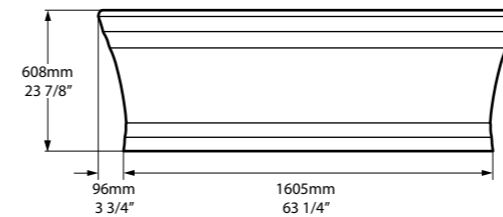

Side View

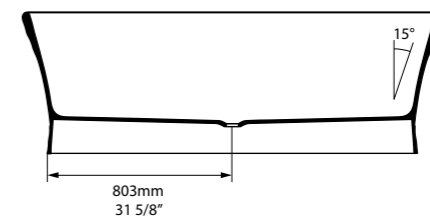

Section AA

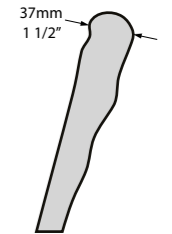

Rim Detail

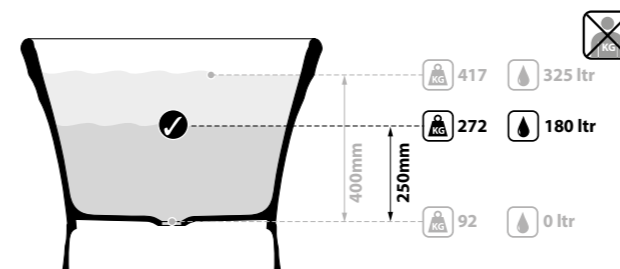

SW Qc rich in Volcanic Limestone AN BK GR MB MW SG

Avec sa profondeur généreuse la baignoire à double dossier d'inspiration victorienne York, dispose d'un élégant socle permettant de dissimuler le système d'évacuation. Disponible en sept couleurs.

Das vom viktorianischen Stil inspirierte Modell York, mit tiefer und doppelseitiger Rückenlehne, ist einfach zu platzieren - der elegante Sockel verbirgt alle Abflußrohre. Erhältlich in 7 Außenfarben.

Caratterizzata da una profonda seduta con doppio schienale, la vasca York ha il pregio di possedere una base elegante che allo stesso tempo nasconde i sistemi di scarico. Disponibile in sette finiture di colore.

Met een diepe, dubbelzijdige ruimte biedt de op Victoriaanse style gebaseerde York een sokkel waar de afvoer verborgen blijft. Verkrijgbaar in zeven kleurafwerkingen.

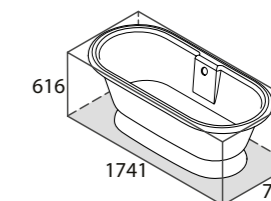

○ YOR-N-SW + YOR-B-SW
 ■ YOR-N-xx + YOR-B-xx
 69Kg

Collections connexes / Entsprechendes Zubehör / Collezioni correlate / Gerelateerde collecties

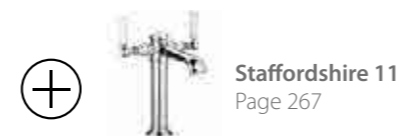



East Hampton, New York, USA

Photography by: Raquel Langworthy



○ YOR-N-SW-OF + YOR-B-SW-OF ☐ ⚠ YOR-N-xx-OF + YOR-B-xx-OF ☐

CE  Massachusetts Code cUPC listing by IAPMO

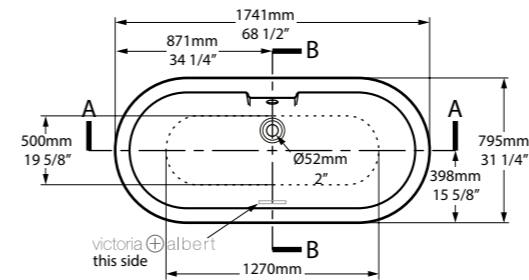

Top View

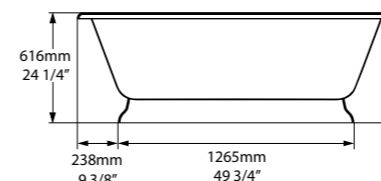

Side View

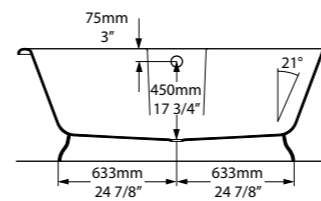

Section AA

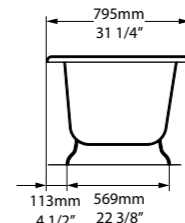

Front View

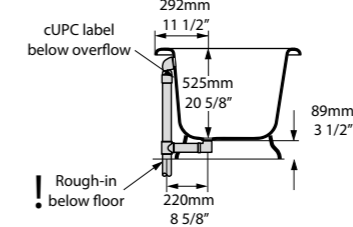

Section BB

 Tap holes can be drilled by installer
 Armaturenlöcher können leicht vom Installateur gebohrt werden
 Les trous de robinetterie peuvent être percés par l'installateur
 Pueden ser perforados por el instalador
 I fori per rubinetti possono essere perforati dall'installatore

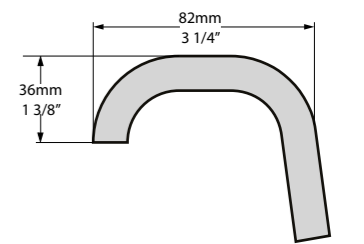
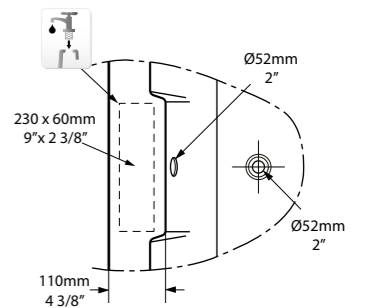

Rim Detail

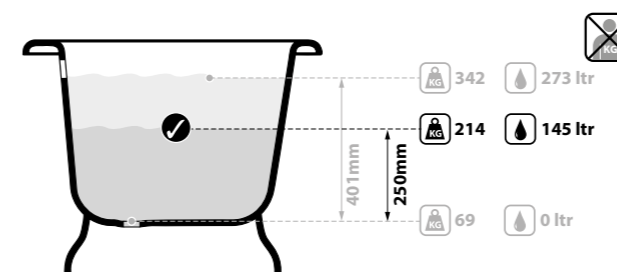

SW  rich in Volcanic Limestone  AN BK GR MB MW SG