



# REVIVRE COMANDI TONDO

EQB DESIGN



TABELLA PREZZI FINITURE	pag. 188
INFO TECNICHE	pag. 188
INDICE / INDEX	pag. 190
DOCCIA INCASSO TERMOSTATICO 1/2"	pag. 192
DOCCIA INCASSO TERMOSTATICO 3/4"	pag. 192
DEVIATORI INCASSO 3/4"	pag. 194
RUBINETTI D'ARRESTO	pag. 195
RUBINETTI INCASSO CON FILTRO	pag. 195



REVIVRE  
COMANDI  
TONDO

**PREZZO FINITURE**

Calcola il prezzo di listino (IVA esclusa) delle finiture diverse dal cromato, consultando la seguente tabella.

Moltiplicare il **PREZZO LISTINO** per il **COEFFICIENTE MOLTIPLICATORE** della finitura scelta, arrotondando per difetto il prezzo ottenuto (eliminare i centesimi).  
**ESEMPIO** per ordinare art. 8812/3H/E in finitura dorato: codice **04-8812/3H/E**

**PRICE FINISHES**

Include the list price (excluding VAT) of different finishes from chrome, consulting the following table. **Multiply the PRICE LIST MULTIPLIER COEFFICIENT** of the chosen finish, **reducing the price obtained by deleting the centesim.**

**EXAMPLE** to order art. 8812/3H/E gold finish: code **04-8812/3H/E**

**COMPOSIZIONE CODICE PER ORDINARE ARTICOLO IN FINITURA**



**CODICE FINITURA**  
FINISH CODE

**CODICE ARTICOLO**  
ITEM NUMBER

**FINITURE DI SERIE / STANDARD FINISHES**

CODICE CODE	DESCRIZIONE FINITURA FINISH DESCRIPTION	MOLTIPLICATORE MULTIPLIER
<b>01-</b>	cromato / chrome	<b>PREZZO LISTINO°</b>

**FINITURE A RICHIESTA / ON REQUEST FINISHES**

CODICE CODE	DESCRIZIONE FINITURA FINISH DESCRIPTION	MOLTIPLICATORE MULTIPLIER
<b>02-</b>	cromo/oro / chrome/gold	x
<b>03-</b>	oro/argento / gold/silver	x
<b>04-</b>	dorato / gold	x
<b>05-</b>	bronzo satinato / satin bronze	x
<b>06-</b>	rame vecchio / old copper	x
<b>07-</b>	vecchio argento / old silver	x
<b>08-</b>	canna di fucile / gun barrel	x
<b>10-</b>	verderame / verdigris	x
<b>11-</b>	nero antracite / anthracite black	x
<b>12-</b>	ottone lucido / polished brass	x
<b>13-</b>	ottone naturale / natural brass	x
<b>14-</b>	bianco / white	x
<b>19-</b>	nero / black	x
<b>28-</b>	nickel satinato / satin nickel	x
<b>30-</b>	nickel lucido / polished nickel	x

**FINITURE A RICHIESTA / ON REQUEST FINISHES**

CODICE CODE	DESCRIZIONE FINITURA FINISH DESCRIPTION	MOLTIPLICATORE MULTIPLIER
<b>33-</b>	cromo satinato / satin chrome	x
<b>34-</b>	cromo spazzolato / brushing chrome	x
<b>35-</b>	nickel spazzolato / brushing nickel	x
<b>56-</b>	avorio / ivory	<b>NON REALIZZABILE*</b>
<b>57-</b>	azzurro / light blue	<b>NON REALIZZABILE*</b>
<b>58-</b>	verdino / light green	<b>NON REALIZZABILE*</b>
<b>59-</b>	marrone / brown	<b>NON REALIZZABILE*</b>
<b>60-</b>	arancio / orange	<b>NON REALIZZABILE*</b>
<b>61-</b>	rosso / red	<b>NON REALIZZABILE*</b>
<b>66-</b>	bianco opaco / mat white	x
<b>67-</b>	nero opaco / mat black	x
<b>68-</b>	rame opaco / mat copper	x
<b>69-</b>	argento opaco / mat silver	x
<b>71-</b>	oro opaco / mat gold	<b>NON REALIZZABILE*</b>
<b>72-</b>	bronzo opaco / mat bronze	x
<b>75-</b>	dorato spazzolato / brushing gold	x
<b>87-</b>	oro rosa / pink gold	x
<b>88-</b>	ottone sisal / sisal brass	<b>NON REALIZZABILE*</b>

°PREZZO DI LISTINO / PRICE LIST

\*NON REALIZZABILE / NOT MADE

**ATTENZIONE! 13-OTTONE NATURALE e 88-OTTONE SISAL: finiture non protette che antichizzano naturalmente ossidando a contatto con l'umidità atmosferica.**  
**WARNING! 13-NATURAL BRASS and 88-SISAL BRASS: unprotected finishes that naturally oxidise in contact with atmospheric humidity.**

**PROGETTO SU MISURA: RICHIESTE SPECIALI**

I tecnici di Bellosta Rubinetterie sono, inoltre, a disposizione di architetti e designers, per offrire un servizio esclusivo: personalizzazioni di elementi in funzione di specifiche richieste estetiche o problematiche legate a vincoli progettuali, verifica della fattibilità attraverso opportuni studi CAD e sviluppo del disegno tecnico del prodotto speciale richiesto.

Per informazioni e richieste **PROGETTI SU MISURA:**  
 ufficiotecnico@bellostarubinetterie.com



**PROGETTO SU MISURA: SPECIAL REQUESTS**

Engineers Bellosta Rubinetterie are also available to architects and designers, to offer an exclusive service: customizations of items according to specific aesthetic requirements or issues related to design constraints, verification of the feasibility studies and development through appropriate CAD technical design the required special product. For information and requests "SU MISURA" PROJECTS:  
 ufficiotecnico@bellostarubinetterie.com

**NOTA VALIDA PER TUTTI I MISCELATORI INCASSO ALTA PORTATA**

Campo di funzionamento da 0,5 bar a 5 bar (per pressioni superiori inserire limitatori di portata). Portata a 3 bar, singola uscita circa 40 l/min.

**NOTE FOR ALL BUILT-IN THERMOSTATIC MIXER HIGH RATE**

From 0,5 bar to 5 bar (for more pressure used flow-limit). From 3 bar, at one way 40 l/min



**COMANDI TERMOSTATICI AD ALTA PORTATA**

Tutti i comandi termostatici ad alta portata possono essere installati in verticale (con entrate dell'acqua calda e fredda rivolte verso il basso) o in orizzontale (con entrate dell'acqua calda e fredda rivolte verso il lato destro).

Blocco di sicurezza a 38 °C

Temperatura minima di esercizio: 3°C FREDDA (consigliata 15°C)

Temperatura massima di esercizio: 80°C CALDA (consigliata 65°C) Differenziale termico consigliato: 50°C

Pressione minima di esercizio: 0.5 bar

Pressione massima di esercizio: 5 bar (per pressioni superiori si raccomanda di installare un limitatore di pressione)

Pressione d'esercizio consigliata: 3 bar

Sistema di sicurezza con blocco dell'erogazione, in caso di mancanza di una delle due acque

Dotati di filtri in acciaio inox per il trattenimento delle impurità

**CARATTERISTICHE DEI TERMOSTATICI ALTA PORTATA DA 1 A 4 USCITE CON PIASTRE UNITE E SINGOLE VINCOLATE**

1) Tutte le uscite sono indipendenti (si possono aprire in contemporanea – in questo caso, logicamente, la portata si ripartisce su tutte le vie aperte).

2) I rubinetti singoli presentano l'erogazione dell'acqua verso destra (o verso l'alto se installati in orizzontale).

3) I termostatici da 1 a 4 uscite presentano tutte le vie di erogazione dell'acqua verso destra (o tutte verso l'alto se installati in orizzontale).

4) A 3 bar, le portate per una singola uscita sono di 40 l/min circa.

**FUNZIONAMENTO:**

Sia con scaldabagni a gas che elettrici ad accumulo

Impianti centralizzati

Caldaie murali e da terra ad accumulo

**ATTENZIONE:**

Si consiglia, di contattare il proprio termoidraulico di fiducia per una corretta e funzionale installazione del miscelatore termostatico, sia con i dispositivi di riscaldamento sopraelencati, che con altre tipologie.

**HIGH RATE THERMOSTATIC MIXER**

All high rate thermostatic mixer can be installed in vertical (with hot and cold water inlets pointing down) or horizontally (with hot and cold water directed toward the right side).

Safety block at 38° C

Minimum working temperature 3°C COLD WATER (suggested 15°C)

Maximum working temperature 80°C HOT WATER (suggested 65°C)

Suggested temperature differential: 50°C

Minimum pressure of working: 0.5 bar

Maximum operating pressure: 5 bar (For higher hydraulic pressures we recommend to install a pressure reducer)

Pressure of working advised: 3 bar

Safety system with water supply block in case either hot or cold water is missing

Supplied with steel filter to keep the impurity out

**FEATURES OF HIGH CAPACITY THERMOSTATIC MIXERS FROM 1 TILL 4 EXITS WITH OPTION OF ONE OR SEPARATE RESTRICTED WALL CONTROLS**

1) All the outflows are unconnected (they can be open at the same time – obviously in this case the water-flow capacity divides onto all the open ways).

2) The single taps have the water-flow towards the right hand-side (or towards the top if they are set up in the horizontal position).

3) The thermostatic mixers with one/four outflows have all the water-flow gateways towards the right hand-side (or all the gateways towards the top if they are set up in the horizontal position).

4) To three bars, the single gateway water-flow capacities are about 40 l/min.

**INSTRUCTIONS:**

It works both with electrical and gas water heater

Central heating systems

Wall and floor boiler

**ATTENTION:**

It is strongly recommended that the product is only installed by a fully qualified plumber who is aware of the installation and the pressure requirements of the system (both for the heating systems above mentioned and others).

**SCHEMA FUNZIONAMENTO MISCELATORI TERMOSTATICI 2/3/4 USCITE**

Leva in posizione ore 12 = deviatore chiuso. Ruotando verso destra o sinistra si attivano le diverse uscite. Partendo dalla posizione di STOP, durante la rotazione la portata dell'acqua si incrementa verso la posizione successiva. Tra 2 uscite adiacenti durante la rotazione diminuisce la portata dell'uscita iniziale ed incrementa quella della successiva. In posizione intermedia sono entrambe attive a pari portata.

**SCHEME OPERATING THERMOSTATIC MIXER 2/3/4 OUT**

Lever to the 12 o'clock position = switch closed. Turning left or right. They activate different outputs. Starting from the STOP position, while rotation of the water flow rate between two adjacent outputs is increased towards the next position. Between two adjacent outputs during the rotation decreases the initial output flow and increases that of the next. In position intermediate are both active at the same flow rate.

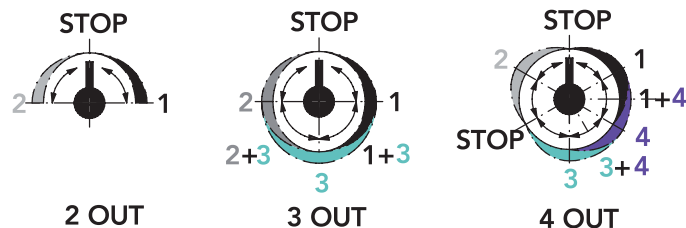

**SCHEMA FUNZIONAMENTO DEVIATORI 2/3/5 USCITE 3/4"**

**DEVIATORI 2/3 USCITE:** Leva in posizione ore 12 = deviatore chiuso. Ruotando verso destra o sinistra si attivano le diverse uscite. Partendo dalla posizione di STOP, durante la rotazione la portata dell'acqua si incrementa verso la posizione successiva. Tra 2 uscite adiacenti durante la rotazione diminuisce la portata dell'uscita iniziale ed incrementa quella della successiva. In posizione intermedia sono entrambe attive a pari portata.

**DEVIATORI 5 USCITE:** Questi deviatori non hanno funzione di chiusura. Ruotando verso destra o sinistra si attivano le uscite. Tra 2 uscite adiacenti durante la rotazione diminuisce la portata dell'uscita iniziale ed incrementa quella della successiva. In posizione intermedia sono entrambe attive a pari portata.

**SCHEME OPERATION SWITCHES FLUSH OUTPUT 2/3/5 3/4"**

**SWITCHES FLUSH OUTPUT 2/3:** Lever to the 12 o'clock position = switch closed. Turning left or right. They activate different outputs. Starting from the STOP position, while rotation of the water flow rate between two adjacent outputs is increased towards the next position. Between two adjacent outputs during the rotation decreases the initial output flow and increases that of the next. In position intermediate are both active at the same flow rate.

**SWITCHES FLUSH OUTPUT 5:** These diverters have not closing function. By turning to the right or left activates the outputs. Between two adjacent outputs during the rotation decreases the initial output flow and increases that of the next. In position intermediate are both active at the same flow rate.

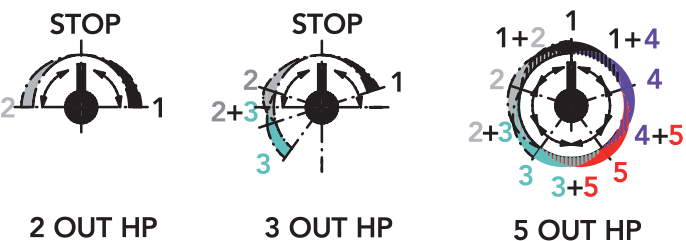

REVIVRE  
COMANDI  
TONDO

**DOCCIA INCASSO TERMOSTATICO 1/2"**



**8812/H/P/E + 484020** pag. 192

MISCELATORE TERMOSTATICO INCASSO 1 USCITA  
BUILT-IN THERMOSTATIC MIXER 1 OUT



parti esterne / external parts: 8812/H/P/E  
parte incasso / built-in part: 484020



**8812/2/P/E + 484021** pag. 192

MISCELATORE TERMOSTATICO INCASSO  
C/DEVIATORE 2 USCITE  
BUILT-IN THERMOSTATIC MIXER WITH DIVERTER  
2 OUT



parti esterne / external parts: 8812/2/P/E  
parte incasso / built-in part: 484021



**8812/3/P/E + 484022** pag. 192

MISCELATORE TERMOSTATICO INCASSO  
C/DEVIATORE 3 USCITE  
BUILT-IN THERMOSTATIC MIXER WITH DIVERTER  
3 OUT



parti esterne / external parts: 8812/3/P/E  
parte incasso / built-in part: 484022



**8812/4/P/E + 484023** pag. 192

MISCELATORE TERMOSTATICO INCASSO  
C/DEVIATORE 4 USCITE  
BUILT-IN THERMOSTATIC MIXER WITH DIVERTER  
4 OUT



parti esterne / external parts: 8812/4/P/E  
parte incasso / built-in part: 484023

**DOCCIA INCASSO TERMOSTATICO 3/4"**



**8812/H/P/E + 774035** pag. 192

MISCELATORE TERMOSTATICO INCASSO 1 USCITA HP  
THERMOSTATIC BUILT-IN MIXER 1 OUT HIGH FLOW  
RATE



parti esterne / external parts: 8812/H/P/E  
parte incasso / built-in part: 774035



**8812/2H/P/E + 774036** pag. 193

MISCELATORE TERMOSTATICO INCASSO 2 USCITE HP  
THERMOSTATIC BUILT-IN MIXER 2 OUT HIGH FLOW  
RATE



parti esterne / external parts: 8812/2H/P/E  
parte incasso / built-in part: 774036



**8812/3H/P/E + 774033** pag. 193

MISCELATORE TERMOSTATICO INCASSO 3 USCITE HP  
THERMOSTATIC BUILT-IN MIXER 3 OUT HIGH FLOW  
RATE



parti esterne / external parts: 8812/3H/P/E  
parte incasso / built-in part: 774033



**8812/4H/P/E + 774034** pag. 193

MISCELATORE TERMOSTATICO INCASSO 4 USCITE HP  
THERMOSTATIC BUILT-IN MIXER 4 OUT HIGH FLOW  
RATE



parti esterne / external parts: 8812/4H/P/E  
parte incasso / built-in part: 774034



**8812/H/E + 884036** pag. 193

MISCELATORE TERMOSTATICO INCASSO 1 USCITA HP  
THERMOSTATIC BUILT-IN MIXER 1 OUT HIGH FLOW  
RATE



parti esterne / external parts: 8812/H/E  
parte incasso / built-in part: 884036



**8812/2H/E + 884037** pag. 193

MISCELATORE TERMOSTATICO INCASSO 2 USCITE HP  
THERMOSTATIC BUILT-IN MIXER 2 OUT HIGH FLOW  
RATE



parti esterne / external parts: 8812/2H/E  
parte incasso / built-in part: 884037



**8812/3H/E + 884038** pag. 194

MISCELATORE TERMOSTATICO INCASSO 3 USCITE HP  
THERMOSTATIC BUILT-IN MIXER 3 OUT HIGH FLOW  
RATE



parti esterne / external parts: 8812/3H/E  
parte incasso / built-in part: 884038



**8812/4H/E + 884039** pag. 194

MISCELATORE TERMOSTATICO INCASSO 4 USCITE HP  
THERMOSTATIC BUILT-IN MIXER 4 OUT HIGH FLOW  
RATE



parti esterne / external parts: 8812/4H/E  
parte incasso / built-in part: 884039



**8812/SH/E + 884040** pag. 194

MISCELATORE TERMOSTATICO S/CHIUSURA HP  
BUILT-IN THERMOSTATIC MIXER HIGH FLOW RATE  
NO CLOSING



parti esterne / external parts: 8812/SH/E  
parte incasso / built-in part: 884040

**DEVIATORI INCASSO 3/4"**



**8803/2H/E + 774047** pag. 194

DEVIATORE INCASSO 2 USCITE HP  
BUILT-IN DIVERTER 2 OUT HIGH FLOW RATE



parti esterne / external parts: 8803/2H/E  
parte incasso / built-in part: 774047



**8803/3H/E + 774048** pag. 194

DEVIATORE INCASSO 3 USCITE HP  
BUILT-IN DIVERTER 3 OUT HIGH FLOW RATE



parti esterne / external parts: 8803/3H/E  
parte incasso / built-in part: 774048



**DEVIATORI INCASSO 3/4"****8803/5H/E + 774049** pag. **195****DEVIATORE INCASSO 5 USCITE HP**  
**BUILT-IN DIVERTER 5 OUT HIGH FLOW RATE**parti esterne / external parts: 8803/5H/E  
parte incasso / built-in part: 774049**RUBINETTI D'ARRESTO****8808/H/E + 774032** pag. **195****RUBINETTO D'ARRESTO HP**  
**BUILT-IN STOP COCK HIGH FLOW RATE**parti esterne / external parts: 8808/H/E  
parte incasso / built-in part: 774032**RUBINETTI INCASSO CON FILTRO****8820/2/E + 094016** pag. **195****RUBINETTO INCASSO CON FILTRO**  
**BUILT-IN STOP COCK WITH FILTER**parti esterne / external parts: 8820/2/E  
parte incasso / built-in part: 094016

## 8812/H/P/E + 484020

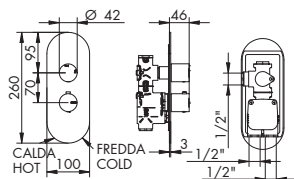

## MISCELATORE TERMOSTATICO INCASSO 1 USCITA

- > cartuccia termostatica
- > vitone ceramico 90°
- > apertura con rotazione antioraria
- > interasse 70 mm
- > ingressi inferiori da 1/2"
- > incasso con B-Box
- > posizionabile orizzontalmente
- > 2 maniglie tonde
- > uscite laterali destra da 1/2"
- > incasso regolabile min 76
- > piastra unica

 775007  
p. 220

 055134  
p. 220

## PARTI ESTERNE - CROMATO

01-8812/H/P/E €

## PARTI ESTERNE - ALTRE FINITURE

XX-8812/H/P/E € x M\*

## PARTE INCASSO

484020 info pag. 181 €

PREZZO TOTALE €

## 8812/2/P/E + 484021

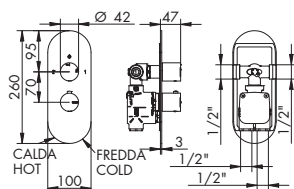

## MISCELATORE TERMOSTATICO INCASSO C/DEVIATORE 2 USCITE

- > cartuccia termostatica
- > deviatore a dischi ceramici 2 uscite c/chiusura
- > interasse 70 mm
- > ingressi inferiori da 1/2"
- > incasso con B-Box
- > piastra unica
- > uscite laterali da 1/2"
- > incasso regolabile min 76
- > 2 maniglie tonde

 775007  
p. 220

 035346  
p. 212

## PARTI ESTERNE - CROMATO

01-8812/2/P/E €

## PARTI ESTERNE - ALTRE FINITURE

XX-8812/2/P/E € x M\*

## PARTE INCASSO

484021 info pag. 181 €

PREZZO TOTALE €

## 8812/3/P/E + 484022

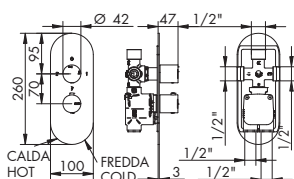

## MISCELATORE TERMOSTATICO INCASSO C/DEVIATORE 3 USCITE

- > cartuccia termostatica
- > deviatore a dischi ceramici 3 uscite c/chiusura
- > interasse 70 mm
- > ingressi inferiori da 1/2"
- > uscite laterali e superiore da 1/2"
- > incasso con B-Box
- > piastra unica
- > incasso regolabile min 76
- > 2 maniglie tonde

 775007  
p. 220

 035345  
p. 212

## PARTI ESTERNE - CROMATO

01-8812/3/P/E €

## PARTI ESTERNE - ALTRE FINITURE

XX-8812/3/P/E € x M\*

## PARTE INCASSO

484022 info pag. 181 €

PREZZO TOTALE €

## 8812/4/P/E + 484023

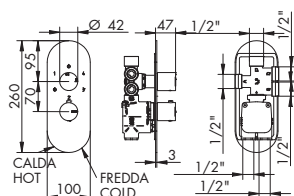

## MISCELATORE TERMOSTATICO INCASSO C/DEVIATORE 4 USCITE

- > cartuccia termostatica
- > deviatore a dischi ceramici 4 uscite c/doppia chiusura
- > interasse 70 mm
- > ingressi inferiori da 1/2"
- > uscite laterali e superiore da 1/2"
- > incasso in ottone con B-Box
- > piastra unica
- > incasso regolabile min 76
- > 2 maniglie tonde

 775007  
p. 220

 035344  
p. 212

## PARTI ESTERNE - CROMATO

01-8812/4/P/E €

## PARTI ESTERNE - ALTRE FINITURE

XX-8812/4/P/E € x M\*

## PARTE INCASSO TERM. 4 OUT DA 1/2"

484023 info pag. 181 €

PREZZO TOTALE €

## 8812/H/P/E + 774035

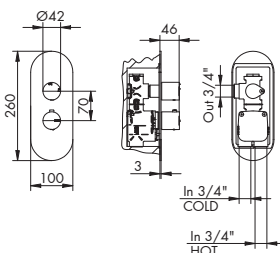

## MISCELATORE TERMOSTATICO INCASSO 1 USCITA HP

- > cartuccia termostatica
- > vitone ceramico 90°
- > apertura con rotazione antioraria
- > interasse 70 mm
- > ingressi inferiori da 3/4"
- > incasso con B-Box
- > posizionabile orizzontalmente
- > 2 maniglie tonde
- > uscita laterale destra da 3/4"
- > incasso regolabile min 76
- > piastra unica

 775007  
p. 220

 055134  
p. 220

## PARTI ESTERNE - CROMATO

01-8812/H/P/E €

## PARTI ESTERNE - ALTRE FINITURE

XX-8812/H/P/E € x M\*

## PARTE INCASSO

774035 info pag. 181 €

PREZZO TOTALE €



## 8812/2H/P/E + 774036

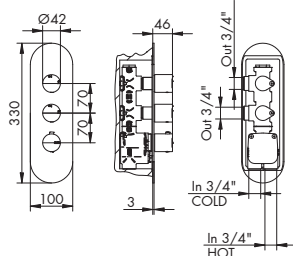

## MISCELATORE TERMOSTATICO INCASSO 2 USCITE HP

- > cartuccia termostatica
- > vitone ceramico 90°
- > 2 aperture con rotazione antioraria
- > interasse 70 mm
- > ingressi inferiori da 3/4"
- > incasso con B-Box
- > posizionabile orizzontalmente
- > 3 maniglie tonde
- > uscite laterali destra da 3/4"
- > incasso regolabile min 76
- > piastra unica



775007

p. 220



055134

p. 220

## PARTI ESTERNE - CROMATO

01-8812/2H/P/E €

## PARTI ESTERNE - ALTRE FINITURE

XX-8812/2H/P/E € x M\*

## PARTE INCASSO

774036 info pag. 182 €

PREZZO TOTALE €

## 8812/3H/P/E + 774033

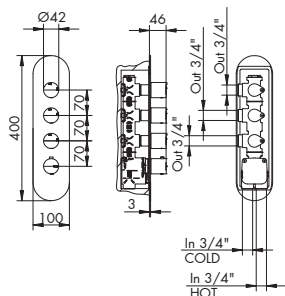

## MISCELATORE TERMOSTATICO INCASSO 3 USCITE HP

- > cartuccia termostatica
- > vitone ceramico 90°
- > 3 aperture con rotazione antioraria
- > interasse 70 mm
- > ingressi inferiori da 3/4"
- > incasso con B-Box
- > posizionabile orizzontalmente
- > 4 maniglie tonde
- > uscite laterali destra da 3/4"
- > incasso regolabile min 76
- > piastra unica



775007

p. 220



055134

p. 220

## PARTI ESTERNE - CROMATO

01-8812/3H/P/E €

## PARTI ESTERNE - ALTRE FINITURE

XX-8812/3H/P/E € x M\*

## PARTE INCASSO

774033 info pag. 182 €

PREZZO TOTALE €

## 8812/4H/P/E + 774034

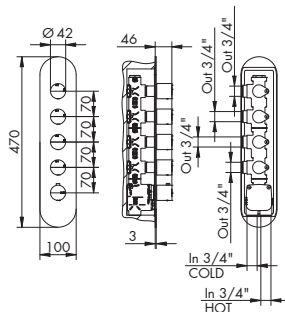

## MISCELATORE TERMOSTATICO INCASSO 4 USCITE HP

- > cartuccia termostatica
- > vitone ceramico 90°
- > 4 aperture con rotazione antioraria
- > interasse 70 mm
- > ingressi inferiori da 3/4"
- > incasso con B-Box
- > posizionabile orizzontalmente
- > 5 maniglie tonde
- > uscite laterali destra da 3/4"
- > incasso regolabile min 76
- > piastra unica



775007

p. 220



055134

p. 220

## PARTI ESTERNE - CROMATO

01-8812/4H/P/E €

## PARTI ESTERNE - ALTRE FINITURE

XX-8812/4H/P/E € x M\*

## PARTE INCASSO

774034 info pag. 182 €

PREZZO TOTALE €

## 8812/H/E + 884036

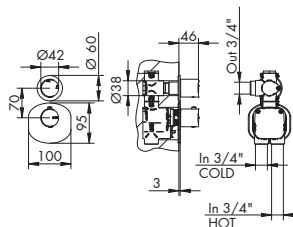

## MISCELATORE TERMOSTATICO INCASSO 1 USCITA HP

- > cartuccia termostatica
- > vitone ceramico 90°
- > apertura con rotazione antioraria
- > interasse 70 mm
- > ingressi inferiori da 3/4"
- > incasso senza B-Box
- > posizionabile orizzontalmente
- > 2 maniglie tonde
- > uscite laterali destra da 3/4"
- > incasso regolabile min 76
- > piastre separate



775007

p. 220



055134

p. 220

## PARTI ESTERNE - CROMATO

01-8812/H/E €

## PARTI ESTERNE - ALTRE FINITURE

XX-8812/H/E € x M\*

## PARTE INCASSO

884036 info pag. 182 €

PREZZO TOTALE €

## 8812/2H/E + 884037

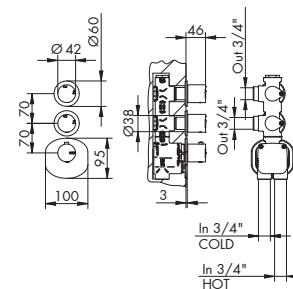

## MISCELATORE TERMOSTATICO INCASSO 2 USCITE HP

- > cartuccia termostatica
- > vitone ceramico 90°
- > 2 aperture con rotazione antioraria
- > interasse 70 mm
- > ingressi inferiori da 3/4"
- > incasso senza B-Box
- > posizionabile orizzontalmente
- > 3 maniglie tonde
- > uscite laterali destra da 3/4"
- > incasso regolabile min 76
- > piastre separate



775007

p. 220



055134

p. 220

## PARTI ESTERNE - CROMATO

01-8812/2H/E €

## PARTI ESTERNE - ALTRE FINITURE

XX-8812/2H/E € x M\*

## PARTE INCASSO

884037 info pag. 182 €

PREZZO TOTALE €



## 8812/3H/E + 884038

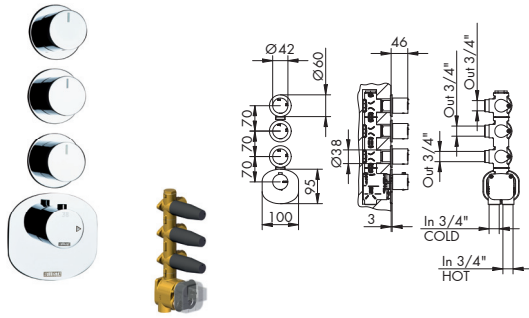

## MISCELATORE TERMOSTATICO INCASSO 3 USCITE HP

- > cartuccia termostatica
- > vitone ceramico 90°
- > 3 aperture con rotazione antioraria
- > interasse 70 mm
- > ingressi inferiori da 3/4"
- > incasso senza B-Box
- > posizionabile orizzontalmente
- > 4 maniglie tonde
- > uscite laterali destra da 3/4"
- > incasso regolabile min 76
- > piastre separate

 775007  
p. 220

 055134  
p. 220

## PARTI ESTERNE - CROMATO

01-8812/3H/E €

## PARTI ESTERNE - ALTRE FINITURE

XX-8812/3H/E € x M\*

## PARTE INCASSO

884038 info pag. 183 €

PREZZO TOTALE € 1.080,00

## 8812/4H/E + 884039

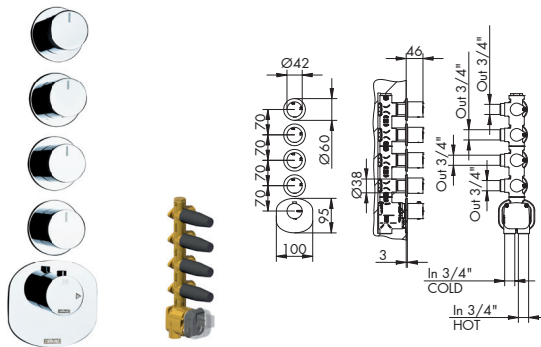

## MISCELATORE TERMOSTATICO INCASSO 4 USCITE HP

- > cartuccia termostatica
- > vitone ceramico 90°
- > 4 aperture con rotazione antioraria
- > interasse 70 mm
- > ingressi inferiori da 3/4"
- > incasso senza B-Box
- > posizionabile orizzontalmente
- > 5 maniglie tonde
- > uscite laterali destra da 3/4"
- > incasso regolabile min 76
- > piastre separate

 775007  
p. 220

 055134  
p. 220

## PARTI ESTERNE - CROMATO

01-8812/4H/E €

## PARTI ESTERNE - ALTRE FINITURE

XX-8812/4H/E € x M\*

## PARTE INCASSO

884039 info pag. 183 €

PREZZO TOTALE €

## 8812/SH/E + 884040

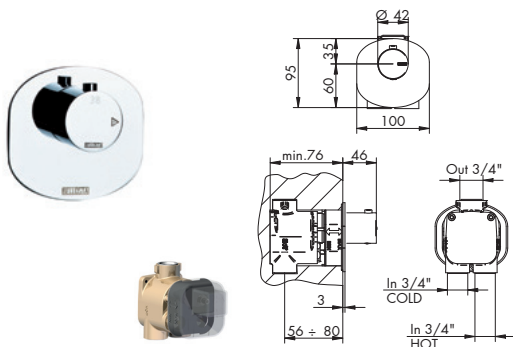

## MISCELATORE TERMOSTATICO S/CHIUSURA HP

- > cartuccia termostatica
- > senza chiusura
- > ingressi inferiori da 3/4"
- > uscita superiore da 3/4"
- > incasso senza B-Box
- > posizionabile orizzontalmente
- > 1 maniglia tonda
- > incasso regolabile min 76

 775007  
p. 220

## PARTI ESTERNE - CROMATO

01-8812/SH/E €

## PARTI ESTERNE - ALTRE FINITURE

XX-8812/SH/E € x M\*

## PARTE INCASSO

884040 info pag. 183 €

PREZZO TOTALE €

## 8803/2H/E + 774047

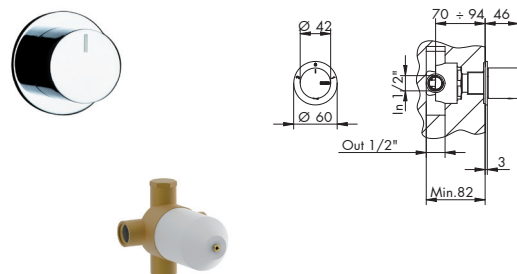

## DEVIATORE INCASSO 2 USCITE HP

- > deviatore a dischi ceramici 2 uscite con chiusura
- > attacchi da 1/2"
- > alta portata
- > maniglia tonda

 775019  
p. 213

## PARTI ESTERNE - CROMATO

01-8803/2H/E €

## PARTI ESTERNE - ALTRE FINITURE

XX-8803/2H/E € x M\*

## PARTE INCASSO

774047 info pag. 183 €

PREZZO TOTALE €

## 8803/3H/E + 774048

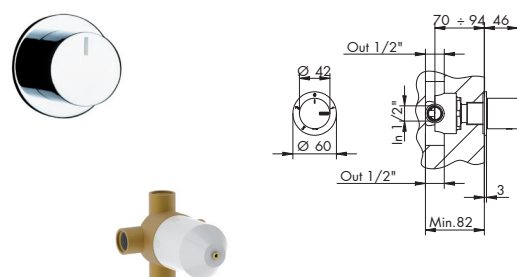

## DEVIATORE INCASSO 3 USCITE HP

- > deviatore a dischi ceramici 3 uscite con chiusura
- > attacchi da 1/2"
- > alta portata
- > maniglia tonda

 775021  
p. 213

## PARTI ESTERNE - CROMATO

01-8803/3H/E €

## PARTI ESTERNE - ALTRE FINITURE

XX-8803/3H/E € x M\*

## PARTE INCASSO

774048 info pag. 183 €

PREZZO TOTALE €



## 8803/5H/E + 774049

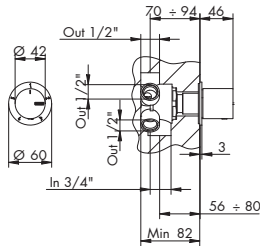

## DEVIATORE INCASSO 5 USCITE HP

- > deviatore a dischi ceramici 5 uscite senza chiusura
- > 1 ingresso inferiore da 3/4"
- > uscite equivalenti da 1/2" a stella
- > maniglia tonda

775019  
p. 213

## PARTI ESTERNE - CROMATO

01-8803/5H/E €

## PARTI ESTERNE - ALTRE FINITURE

XX-8803/5H/E € x M\*

## PARTE INCASSO

774049 info pag. 184 €

PREZZO TOTALE €

## 8808/H/E + 774032

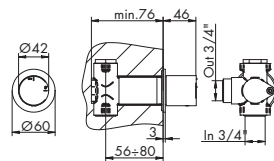

## RUBINETTO D'ARRESTO HP

- > vitone ceramico 90°
- > maniglia tonda
- > attacchi da 3/4"

055134  
p. 220

## PARTI ESTERNE - CROMATO

01-8808/H/E €

## PARTI ESTERNE - ALTRE FINITURE

XX-8808/H/E € x M\*

## PARTE INCASSO

774032 info pag. 184 €

PREZZO TOTALE €

## 8820/2/E + 094016

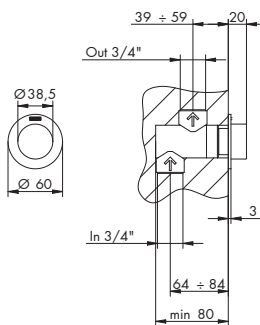
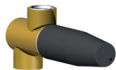

## RUBINETTO INCASSO CON FILTRO

- > attacchi da 3/4"
- > filtro interno per raccolta macro impurità
- > rosone tondo

## PARTI ESTERNE - CROMATO

01-8820/2/E €

## PARTI ESTERNE - ALTRE FINITURE

XX-8820/2/E € x M\*

## PARTE INCASSO

094016 info pag. 184 €

PREZZO TOTALE €

REVIVRE  
COMANDI  
TONDOCARTUCCIA  
DEVIATRICEVITONE  
CERAMICO