



Minuteria

Sanitary wares



ART. 2000

Maniglione di sicurezza per disabili per doccia, vasca, WC, bidet.

Shower box, bathtub, WC, bidet and towel-holder safety handle for disabled.



Codice Code	cm	Conf. Pack	€ cad. € each
4092040	30	1	34,00
4092042	40	1	37,00
4092043	45	1	40,00
4092044	60	1	43,00
4092045	80	1	50,00
4092046	90	1	51,00

ART. 2001

Maniglione di sicurezza in PVC medicale rigato lucido bianco s/tasselli.

PVC safety handle without plugs.

**PVC**

Codice Code	cm	Conf. Pack	€ cad. € each
4092230	30	1	14,80
4092240	40	1	16,20
4092260	60	1	21,60

ART. 2002

Maniglione di sicurezza a 45°.

45° Safety handle.



Codice Code	cm	Conf. Pack	€ cad. € each
4092049	25x25	1	59,00

ART. 2004

Corrimano ad angolo per disabili.

Shower and bathtub angle handrail for disabled.



Codice Code	cm	Conf. Pack	€ cad. € each
4092050	70x70	1	136,00
4092071	100x100	1	151,00

ART. 2006

Corrimano ad angolo per disabili con montante destro.

Shower and bathtub angle handrail for disabled with right side riser.

**DX**

Codice Code	cm	Conf. Pack	€ cad. € each
4092056	70x40 Dx Right side	1	118,00

ART. 2007

Corrimano ad angolo con montante sinistro.

Shower and bathtub angle handrail for disabled with left side riser.

**SX**

Codice Code	cm	Conf. Pack	€ cad. € each
4092058	70x40 Sx Left side	1	118,00

ART. 2007/A

Corrimano ad angolo UNIVERSALE per disabili con montante sinistro o destro.

Shower and bathtub angle handrail for disabled universal side riser.



Codice Code	cm	Conf. Pack	€ cad. € each
4092057	70x40 Universale	1	135,00

ART. 2008

Corrimano di sicurezza verticale cm.160.

Wall vertical handrail.



Codice Code	cm	Conf. Pack	€ cad. € each
4092072	parete-parete	1	165,00

ART. 2009

Corrimano di sicurezza verticale cm.160.

Wall vertical handrail.



Codice Code	cm	Conf. Pack	€ cad. € each
4092041	parete-pavimento	1	165,00

ART. 2010

Barra ribaltabile in verticale.

Vertical folding bar.



Codice Code	cm	Conf. Pack	€ cad. € each
4092067	60	1	150,00
4092066	80	1	228,00

ART. 2011

Barra ribaltabile in verticale con portarotolo.

Vertical folding bar.

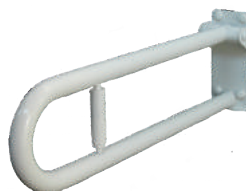

Codice Code	cm	Conf. Pack	€ cad. € each
4092069	80 c/portarotolo	1	170,00

ART. 2012

Barra ribaltabile ergonomica

Folding supporting bar.



Codice Code	cm	Conf. Pack	€ cad. € each
4092073	70	1	175,00



NEW

ART. 2014			
Sedile ribaltabile con doghe per doccia. <i>Shower tip-up seat.</i>			
Codice Code	Conf. Pack	€ cad. € each	
4092063	1	160,00	



NEW

ART. 2016			
Sedile ribaltabile per doccia per disabili spogliatoi, gabinetti medici, ecc. <i>Shower tip-up seat for disabled which is located in changing-rooms, surgeries etc..</i>			
Codice Code	Conf. Pack	€ cad. € each	
4092082	1	110,00	



ART. 2017			
Sedile regolabile per vasca in polipropilene bianco s/tasselli. <i>Bath seat without plugs.</i>			
Codice Code	Conf. Pack	€ cad. € each	
4092301	1	113,00	



ART. 2018			
Specchio ad inclinazione regolabile per disabili. <i>Adjustable mirror for disabled.</i>			
Codice Code	cm	Conf. Pack	€ cad. € each
4092034	46x56	1	213,00



ART. 2020			
Sedile universale altezza cm. 10 con apertura. <i>Universal seat, heigh 10 cm. with opening.</i>			
Codice Code	Conf. Pack	€ cad. € each	
4092096	1	178,00	
4092097	c/coperchio	296,00	



ART. 2021			
Sedile in polipropilene bianco con fermi altezza cm 10. <i>Universal white seat height cm 10.</i>			
Codice Code	Conf. Pack	€ cad. € each	
4092401	1	54,00	
4092402	c/coperchio	77,00	



NEW

ART. 2021/B			
Sgabello da bagno per doccia con altezza regolabile. <i>Bathroom stool with adjustable engh.</i>			
Codice Code	H cm	Conf. Pack	€ cad. € each
8644025	40	1	82,00



ART. 2022			
Lavabo in ceramica con appoggia gomiti, bordo anteriore concavo. <i>Baked ceramic wash-basin with elbowrest.</i>			
Codice Code	Conf. Pack	€ cad. € each	
4092030	1	220,00	
4092031	coppia staffe x lavabo	58,00	
4092080	meccanismo pneumatico	290,00	



ART. 2024			
Wc-bidet in ceramica con apertura anteriore per funzione bidet. <i>Ceramic wc-bidet with front opening for bidet function.</i>			
Codice Code	Conf. Pack	€ cad. € each	
4092036	1	220,00	
Sedile avvolgente x detto/cover seat			
4092111	1	105,00	



ART. 2026			
Vaso in ceramica con scarico unificato parete/pavimento. <i>Wc with front and floor wall drain.</i>			
Codice Code	Conf. Pack	€ cad. € each	
4092037	1	260,00	
Sedile x detto/cover seat			
4092038	1	105,00	



ART. 2028			
Bidet in ceramica a terra. <i>Ceramic bidet.</i>			
Codice Code	Conf. Pack	€ cad. € each	
4092039	1	255,00	



ART. 2029			
Idroscopino a pressione per pulizia WC cromato. <i>Hydrotoilet brush WC.</i>			
Codice Code	Conf. Pack	€ cad. € each	
4092013	1	90,00	



ART. 2029/A			
Doccetta a pulsante con supporto.			
Codice Code	Conf. Pack	€ cad. € each	
4092026	10	6,00	



ART. 2031

Distributore di sapone liquido in PVC trasparente 1 pulsante.
Transparent PVC liquid soap dispenser.

Codice Code	Lt	Conf. Pack	€ cad. € each
5016502	0,500	20	16,00



ART. 2033

Distributore di sapone liquido in PVC trasparente 2 pulsanti.
Transparent PVC liquid soap dispenser 2 buttons.

Codice Code	Lt	Conf. Pack	€ cad. € each
5016503	0,800	20	20,00



ART. 2035

Dosatore di sapone liquido a pulsante in acciaio inox.
Safety lock stainless steel liquid soap dispenser.

Codice Code	Lt	Conf. Pack	€ cad. € each
8085010	0,800	1	69,00



ART. 2037

Asciugamani elettrico bianco.
Potenza totale 1650 Watt.
Hand dryer.

Codice Code		Conf. Pack	€ cad. € each
5140205	Manuale con pulsante <i>Manual with push button</i>	1	248,00
5140206	Automatico con fotocellula <i>Photocell operated</i>	1	248,00



ART. 2039

Asciugamani elettrico bianco.
Potenza totale 2250 Watt.
Hand dryer.

Codice Code		Conf. Pack	€ cad. € each
5140301	Manuale con pulsante <i>Manual with push button</i>	1	565,00
5140302	Automatico con fotocellula <i>Photocell operated</i>	1	565,00



ART. 2041

Asciugamani elettrico Inox lucido AISI 304.
Potenza totale 2250 Watt.
Hand dryer.

Codice Code		Conf. Pack	€ cad. € each
5140305	Manuale con pulsante <i>Manual with push button</i>	1	770,00
5140306	Automatico con fotocellula <i>Photocell operated</i>	1	770,00



ART. 2044

Pasta lavamani al limone.
Lemon hand-washing compound.

Codice Code	barattoli can	Conf. Pack	€ cad. € each
0121621	1 kg	24	4,40
0121624	4 kg	6	14,00



ART. 2046

Sapone liquido in lattina.
Canned liquid soap.

Codice Code	kg	Conf. Pack	€ cad. € each
0121631	1	12	7,10
0121635	5	4	31,00



ART. 2048

COMBI - Trasparente / *Transparent*
Distributore di asciugamani in carta in rotolo a strappo e a fogli piegati a "C" o intercalati.
Dispenser for paper towels in rolls or folded in rolls - "C" folded or interfolded.

Codice Code	Ø	Conf. Pack	€ cad. € each
8081201	155x240	2	50,00

ART. 2050

Rotolo carta per detto.
Paper roll for art. 2048.

Codice Code		Conf. Pack	€ cad. € each
0902003		10	5,00



ART. 2052

Carrello portarotolo a pavimento.
Floor roll-holder truck.

Codice Code		Conf. Pack	€ cad. € each
0902010		1	46,00



ART. 2054

Carrello portarotolo a muro.
Wall roll-holder truck.

Codice Code		Conf. Pack	€ cad. € each
0902012		1	31,00



ART. 2056

Carta in rotoli pura cellulosa.
Tearing wood pulp paper rolls.

Codice Code		Conf. Pack	€ al rotolo € roll
0902004		2	14,00



ART. 2060

Gruppo vasca esterno con doccia.
Bath tub mixer with normal shower.

Codice Code	Conf. Pack	€ cad. € each
5023002	2	89,00



ART. 2062

Batteria lavabo con scarico automatico.
Wash basin mixer with pop-up waste 1 1/4.

Codice Code	Conf. Pack	€ cad. € each
5023006	2	97,70



ART. 2064

Combinazione bidet con scarico automatico.
Bidet mixer with pop-up waste 1 1/4.

Codice Code	Conf. Pack	€ cad. € each
5023018	2	66,00



ART. 2066

Rubinetto collo cigno 1/2".
Wash basin pillar tap, 1/2".

Codice Code	Conf. Pack	€ cad. € each
5023020	4	31,00



ART. 2068

Rubinetto bidet 1/2".
Bidet tap 1/2".

Codice Code	Conf. Pack	€ cad. € each
5023012	4	22,00



ART. 2070

Rubinetto collo cigno c/leva gomito.
Elbow-operated swan-necked tap.

Codice Code	Ø	Conf. Pack	€ cad. € each
5161008	1/2"	4	45,00



ART. 2072

Rubinetto prolungato c/leva gomito.
Elbow-operated long-necked tap.

Codice Code	Ø	Conf. Pack	€ cad. € each
5161208	1/2"	4	35,00



ART. 2074

Rubinetto colonna con canna girevole.
Rotary column tap.

Codice Code	Ø	Conf. Pack	€ cad. € each
5160808	1/2"	4	40,00



ART. 2076

Rubinetto collo cigno a pulsante temporizzato 6/8 secondi.
Button swan-necked timed tap.

Codice Code	Ø	Conf. Pack	€ cad. € each
5165008	1/2"	2	36,00



ART. 2078

Rubinetto pulsante frontale temporizzato 6/8 secondi.
Front button timed tap.

Codice Code	Ø	Conf. Pack	€ cad. € each
5165208	1/2"	2	51,00



ART. 2080

Rubinetto pulsante a collo cigno temporizzato 6/8 secondi.
Timed tap with high button.

Codice Code	Ø	Conf. Pack	€ cad. € each
5165268	1/2"	2	67,00



ART. 2082

Cartuccia di ricambio per rubinetti temporizzati. Art. 2076-2078-2080
Spare cartridge for temporized (timer) taps art. 2076-2078-2080.

Codice Code	Conf. Pack	€ cad. € each
5165290	2	26,00



ART. 2084

Rubinetto miscelatore a fotocellula per lavabo con alimentazione a batteria 6 V.
Electronix faucet.

Codice Code	Conf. Pack	€ cad. € each	
5140210	CROMO	1	435,00

**ART. 2090**

Rubinetto a pavimento a un pedale 1/2".
1/2" single-pedal floor cock.

Codice Code	marca		€ cad. € each
5180201	River	Montaggio a pavimento	122,00
5180230	GT	Montaggio a pavimento e parete	68,00

**ART. 2102**

Spartiacqua Ø 1/2" per orinatoio.
Ø 1/2" WC ridge-pipe.

Codice Code		Conf. Pack	€ cad. € each
5200608	Curvo Bent pipe	4	28,00

**ART. 2092**

Rubinetto miscelatore a pavimento a due pedali. Uno per acqua fredda - Uno per acqua calda 1/2".
1/2" floor mixing faucet with two pedals, one for cold water and the other for hot water.

1/2" floor mixing faucet with two pedals, one for cold water and the other for hot water.

Codice Code	marca	Conf. Pack	€ cad. € each
5180202	River	2	192,00

**ART. 2104**

Rubinetto orinatoio temporizzato a 15 secondi con possibilità di regolazione.
Adjustable 15-second timing WC tap.

Codice Code	Ø	Conf. Pack	€ cad. € each
5200201	1/2"	4	58,00

**ART. 2094**

Miscelatore monopedale a pavimento più si preme il pedale e più l'acqua diventa calda.
Single-pedal floor mixing faucet. Pressing the pedal, water gets warmer.

Single-pedal floor mixing faucet. Pressing the pedal, water gets warmer.

Codice Code	marca		€ cad. € each
5180204	River	Montaggio a pavimento	205,00
5180234	GT	Montaggio a pavimento e parete	88,00

**ART. 2106**

Piletta di scarico per orinatoio.
WC drain.

Codice Code	Ø	Conf. Pack	€ cad. € each
5201012	1"1/4	4	39,00

**ART. 2096**

Rubinetto a pedale da incasso temporizzato 15 secondi a 3 bar.
Inset pedal cock.

Inset pedal cock.

Codice Code	Ø	Conf. Pack	€ cad. € each
5181003	1/2"	2	107,00

**ART. 2108**

Bicchiera per orinatoio dritto.
WC straight joint sleeve.

Codice Code	Ø	Conf. Pack	€ cad. € each
5201210	1"	10	18,00

**ART. 2098**

Bocca erogazione orientabile.
Rotating water supply tube provided with standard.

Rotating water supply tube provided with standard.

Codice Code	Ø	Conf. Pack	€ cad. € each
5221401	1/2"	2	35,00

**ART. 2110**

Bicchiera curva per orinatoio.
WC bent joint sleeve.

Codice Code	Ø	Conf. Pack	€ cad. € each
5201410	1"	10	26,00

**ART. 2100**

Rubinetto per orinatoio antivandalo a pulsante.
Button WC tap.

Button WC tap.

Codice Code	Ø	Conf. Pack	€ cad. € each
5200408	1/2"	4	50,00

**ART. 2112**

Spartiacqua cromato per vasi alla turca dritto.
Water-closet chromium-plated ridge-pipe.

Water-closet chromium-plated ridge-pipe.

Codice Code		Conf. Pack	€ cad. € each
5201810		4	16,00

**ART. 2114**

Flussometro esterno a pulsante temporizzato.
External press-button flushometers.

Codice Code	Ø	Conf. Pack	€ cad. € each
5165609	3/4"	2	50,50
5165660	1"	2	51,50

**ART. 2126**

Tubo telescopico in ottone cromato regolabile 60-80 mm per passo rapido.
Coarse pitch adjustable chromium-plated brass extension tube.

Codice Code	Ø	Conf. Pack	€ cad. € each
1102569	3/4"	4	19,50
1102570	1"	4	22,00

**ART. 2116**

Flussometro a pulsante da incasso temporizzato.
Built in press-button flushometer without water hammer.

Codice Code	mm	Conf. Pack	€ cad. € each
1102518	3/4"	2	52,50
1102519	1"	2	54,50

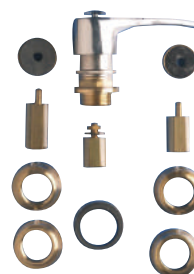
**ART. 2128**

Vitoni universali per passi rapidi.
Coarse pitch general purpose large screws.

Codice Code	Conf. Pack	€ cad. € each
5150091	4	36,00

**ART. 2118**

Passorapido esterno con leva.
External flushing valve with lever.

Codice Code	Ø	Conf. Pack	€ cad. € each
1102515	3/4"	2	39,00
1102516	1"	2	42,00

**ART. 2130**

Vitoni universali per rubinetteria tradizionale in blister.
Packed traditional tap Universal large screws.

Codice Code	Conf. Pack	€ cad. € each
5150090	4	18,00

**ART. 2120**

Passo rapido incasso c/sfiatatoio.
Built-in flushing valve with lever.

Codice Code	Ø	Conf. Pack	€ cad. € each
1102509	3/4"	2	41,50
1102510	1"	2	45,00

**ART. 2132**

Rubinetto a sfera ad incasso per acqua a leva.
Water lever inset ball cock.

Codice Code	Ø	Conf. Pack	€ cad. € each
1105508	1/2"	8	14,80
1105509	3/4"	6	21,00

**ART. 2122**

Passo rapido esterno automatico.
Automatic external flushing valve with lever.

Codice Code	Ø	Conf. Pack	€ cad. € each
1102539	3/4"	2	66,00
1102530	1"	2	69,00

**ART. 2134**

Rubinetto a sfera ad incasso per acqua c/ cappuccio.
Water cap inset ball cock.

Codice Code	Ø	Conf. Pack	€ cad. € each
1105908	1/2"	10	15,50
1105909	3/4"	5	21,60

**ART. 2124**

Passo rapido incasso automatico.
Automatic built-in flushing valve with lever.

Codice Code	Ø	Conf. Pack	€ cad. € each
1102522	3/4"	2	65,00
1102520	1"	2	68,00

**ART. 2136**

Rubinetto a sfera ad incasso per acqua con maniglia.
Water handle inset ball cock.

Codice Code	Ø	Conf. Pack	€ cad. € each
1105708	1/2"	6	15,00
1105709	3/4"	5	17,20



ART. 2140

Doccetta duplex ad incasso completa.
Whole set of inset duplex shower.

Codice Code	cm	Conf. Pack	€ cad. € each
8060502	150	10	25,00



ART. 2142

Doccetta duplex completa a muro.
Whole set of inset duplex shower.

Codice Code	cm	Conf. Pack	€ cad. € each
8060501	150	10	18,50



ART. 2144

Supporto per duplex esterno.

Codice Code	Conf. Pack	€ cad. € each
8060515	10	4,90



ART. 2146

Supporto per duplex esterno con attacco conico.

Codice Code	Conf. Pack	€ cad. € each
8060514	10	5,50



ART. 2148

Doccia telefono curva.
Bent Telephone-shaped shower.

Codice Code	Conf. Pack	€ cad. € each
8060505	10	5,70



ART. 2150

Doccia telefono dritta.
Straight telephone-shaped shower.

Codice Code	Conf. Pack	€ cad. € each
8060506	10	5,80



ART. 2152

Tappo in gomma con copritappo inox.
Stainless steel plug-cover rubber plug.

Codice Code	Ø x cm	Conf. Pack	€ cad. € each
0169227	27 / 25	25	1,20
0169231	31 / 25	25	1,22
0169240	40 / 45	25	1,55
0169244	44 / 45	25	1,60
0169247	47 / 45	25	1,70
0169252	52 / 32	25	1,63
0169241	40 / 65	25	2,30

A richiesta in bustine tipo blister + 0,15 cad. netto.
Plugs can be packed upon demand and the price of each plug is subject to a 0,15 net increase.



ART. 2154

Tappo in gomma nero Ø 52.
Stainless steel plate rubber plug.

Codice Code		Conf. Pack	€ cad. € each
0169452	c/placca inox	10	0,88
0169454	s/placca	10	0,66

A richiesta in bustine tipo blister + 0,15 cad. netto.
Plugs can be packed upon demand and the price of each plug is subject to a 0,15 net increase.



ART. 2156

Tappo in gomma nera.
Black rubber plug.

Codice Code	Ø x cm	Conf. Pack	€ cad. € each
0169140	40 / 45	25	1,40
0169144	44 / 45	25	1,42
0169147	47 / 45	25	1,45
0169152	52 / 32	25	1,40
0169157	57 / 32	25	1,44

A richiesta in bustine tipo blister + 0,15 cad. netto.
Plug can be packed upon demand and the price of each plug is subject to a 0,15 net increase.



ART. 2158

Tappo in gomma nera c/copriforo inox.
Stainless steel hole-cover black rubber plug.

Codice Code	Ø x cm	Conf. Pack	€ cad. € each
0169127	27 / 25	25	1,55
0169131	31 / 25	25	1,56
0169139	40 / 25	25	1,62

A richiesta in bustine tipo blister + 0,15 cad. netto.
Plugs can be packed upon demand and the price of each plug is subject to a 0,15 net increase.



ART. 2160

Cestello in acciaio inox per piletta sifoide.
Siphon drain stainless steel drip pipe.

Codice Code	Ø	Conf. Pack	€ cad. € each
5222906	40	10	3,60



ART. 2162

Cestello in acciaio inox per vasca.
Bathtub stainless steel drip pipe.

Codice Code	Ø	Conf. Pack	€ cad. € each
5222916	36	10	3,35



ART. 2164

Griglietta inox per pilette.
Drain stainless steel small grid.

Codice Code	Conf. Pack	€ cad. € each
5222915	10	0,54



ART. 2166

Griglietta inox per piletta livello.
Drain stainless steel grid for sink.

Codice Code	Conf. Pack	€ cad. € each
5222925	10	1,00



ART. 2180

Cassetta Kariba 2008 c/tubo Ø 40 .
Kariba WC cistern.

Codice Code	colore color	Conf. Pack	€ cad. € each
0181006	bianco	10	60,00
Solo coperchio bianco/White cover			
0182201		1	17,60



ART. 2181

Cassetta Kariba 2008 DUO, doppio tasto
6 o 9 litri.
Kariba DUO cistern with double function key
6/9 lt.

Codice Code	colore color	Conf. Pack	€ cad. € each
0181005	bianco	10	65,00



ART. 2182

Cassetta super Kariba.
Super Kariba WC cistern.

Codice Code	colore color	Conf. Pack	€ cad. € each
0181201	bianco	5	79,00
Solo coperchio bianco/White cover			
0182200		1	31,00



ART. 2184

Cassetta Kariba Biblo Duo doppio
comando per il risparmio dell'acqua:
completo 6/9 litri-parziale 3 litri.
Biblo Duo wc cistern with safety water cover.

Codice Code	colore color	Conf. Pack	€ cad. € each
0181205	Bianco	1	90,00
Solo coperchio bianco/White cover			
0182208		1	32,00



ART. 2186

Tubo per Kariba. Kariba WC cistern tube.

Codice Code	tubo	Conf. Pack	€ cad. € each
0181518	50x32x60	10	14,60
0181522	50x32x100	10	21,80
0181525	Dadone	10	11,50



ART. 2188

Rubinetto galleggiante originale Norma
Kariba.
Original norma Kariba ball cock.

Codice Code	Conf. Pack	€ cad. € each
0181506	10	20,00



ART. 2190

Rubinetto galleggiante universale.
Float valve with tub.

Codice Code	Ø	Conf. Pack	€ cad. € each
0181599	3/8"	10	14,00



ART. 2192

Guarnizione valvola scarico universale Kariba.
Exhaust valve universal ring.

Codice Code	Art. Kariba	Conf. Pack	€ cad. € each
0181508	410070 Ø 24x60	10	4,05
0181510	114017 Ø 19x79	10	5,70
0181509	112153 Ø 19x60	10	6,50



ART. 2194

Cassetta a zaino in ABS It. 9, pulsante
economizzatore d'acqua start/stop.
Wc Cistern made in ABS capacity 9 lt., water
saving start/stop button.

Codice Code	colore color	Conf. Pack	€ cad. € each
0181101	bianco	10	35,00



ART. 2196

Cassetta a doppio scarico in ABS, lt. 9
scarico regolabile da 3 a 4,5 lt.
Double flush wc-cistern made in ABS capacity 9
lt. partial flush adjustable from 3 to 4,5 lt.

Codice Code	colore color	Conf. Pack	€ cad. € each
0181105	bianco	10	42,00



ART. 2198

Cassetta di scarico ad angolo in ABS It.9.
ABS angle flush tank lt.9.

Codice Code	colore color	Conf. Pack	€ cad. € each
0184000	bianco	2	85,00



ART. 2200

Cassetta alta in plastica con meccanismo
di scarico (escluso coperchio e sifone).
Large plastic flush tank.

Codice Code		€ cad. € each
0184201	Cassetta s/coperchio	19,40
0184310	Coperchio/Cover	4,60
0184302	Leva/Lever	1,40
0184305	Sifone/Siphon	8,80
0184303	Dado e contro dado Nut and lock nut	2,00
0184304	Guarnizione/Ring	0,77
0184309	Meccanismo di scarico	6,70

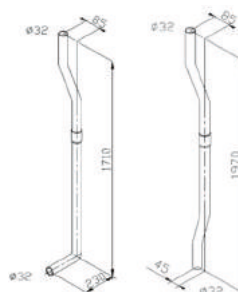

ART. 2202

Tubo per cassetta alta da incasso Ø 32
Built in pipe for high level cistern.

Codice Code	curva	Conf. Pack	€ cad. € each
0184445	45° e 90°	10	7,50
0184490	90° e 90°	10	8,00



ART. 2204

Pull con catenella bianchi.
White chain pulls.

Codice Code	cm	Conf. Pack	€ cad. € each
0186070	70	10	1,95
0186090	100	10	2,42
In bustina singoli./Single packed pulls.			
0186071	70	10	2,25
0186091	100	10	2,70

**ART. 2220**

CASSETTA PUCCI SARA INCASSO PER PARETI IN MURATURA

Pulsante alto Lt 9.

Completa di tubo di risciacquamento 35x11 cm regolabile in altezza (+2/-2 cm), rosone eccentrico, canotto 22 cm, morsetto combinato Ø 48-58 mm con coprimorsetto, staffe di sostegno per fissaggio cassette e rete per l'intonaco.

POLYETHYLENE TANK FOR BRICK WALLS HIGH
Set push button Lt. 9.

Completed with 35x11 cm. Adjustable flush pipe (+2/-2 cm). Eccentric escutcheon 22 cm joint. Ø48-58 mm combined clamp with clamp cover. Flush tank fixing brackets and plastic net.

Codice Code		Conf. Pack	€ cad. € each
0180510	senza placca	1	120,00
0180505	placca bianca per detta spessore 4,7 mm 80130660	1	26,00

**ART. 2222**

CASSETTA PUCCI ECO PER PARETI IN MURATURA

Due pulsanti Lt 9/4.

Completa di tubo di risciacquamento 35x11 cm regolabile in altezza (+2/-2 cm), rosone eccentrico, canotto 22 cm, morsetto combinato Ø 48-58 mm con coprimorsetto, staffe di sostegno per fissaggio cassette e rete per l'intonaco.

POLYETHYLENE TANK FOR BRICK WALLS
Double push button flush tank Lt 9/4.

*Completed with 35x11 cm adjustable flush pipe (+2/-2 cm). Eccentric escutcheon 22 cm joint. Ø48*58 mm combined clamp with clamp cover. Flush tank fixing brackets.*

Codice Code		Conf. Pack	€ cad. € each
0180507	senza placca	1	170,00
0180528	placca bianca per detta spessore 4,7 mm 80130550	1	35,50

**ART. 2223**

PLACCHE PUCCI CON TELAIO PORTAPLACCA PRODUZIONE 2011-2013
PUCCI COVER PLATE PRODUCTION 2011-2013

Codice Code		Conf. Pack	€ cad. € each
0180511	placca bianca per cassetta Sara incasso mod. Pucci 8000620	1	26,00
0180502	placca bianca per cassetta Eco incasso mod. Pucci 8000520	1	35,40

**ART. 2225**

KIT per cassetta PUCCI

Confezione composta da 4 pezzi cappello - membrane - fondo e n° 2 fibra.

Kit for Pucci tank
Packaging includes a cap, a membrane, its bottom and 2 fibres.

Codice Code		Conf. Pack	€ cad. € each
0180585		10	2,30

ART. 2228 RICAMBI ORIGINALI PUCCI SARA/PUCCI SARA ORIGINAL SPARE PARTS

Codice GT <i>Code GT</i>	Codice Pucci <i>Code Pucci</i>	Descrizione	Conf. <i>Pack</i>	€ cad. <i>€ each</i>
0180591	6010	Telaio guida	5	1,50
0180511	0620	Placca Sara bianca con pulsante ovale con telaio porta placca	1	26,00
0180503	6180	Salterello per sportello Sara	1	4,80
0180610	6233	Vite registro Ø M8	5	3,43
0180611	6240	Sportello completo Sara	1	17,16
0180612	6260	Sfera con tirantino Sara	1	10,55
0180504	6261	Gruppo completo sfera + astina	1	14,40
0180613	6281	Vite inox Ø M5 per telaio	10	0,64
0180617	6535	Staffa sostegno valvola con vite e rondella zincata	2	3,21
0180618	6543	Flessibile FF con guarnizioni	1	15,23
0180619	6544	Rubinetto ottone 1/2" con supporto polietilene	1	22,21
0180620	6550	Gruppo valvola completo	1	34,00
0180621	6555	Pistoncino con guarnizione 10x5 mm	10	1,83
0180622	6560	Gruppo completo tubo di cacciata 35 cm canotto 22 cm - rosone eccentrico e morsetto universale bianco	1	22,55
0180623	6595	Sede estraibile con OR 147	1	12,13
0180624	6596	OR 147 per sede estraibile e codulo	8	0,78

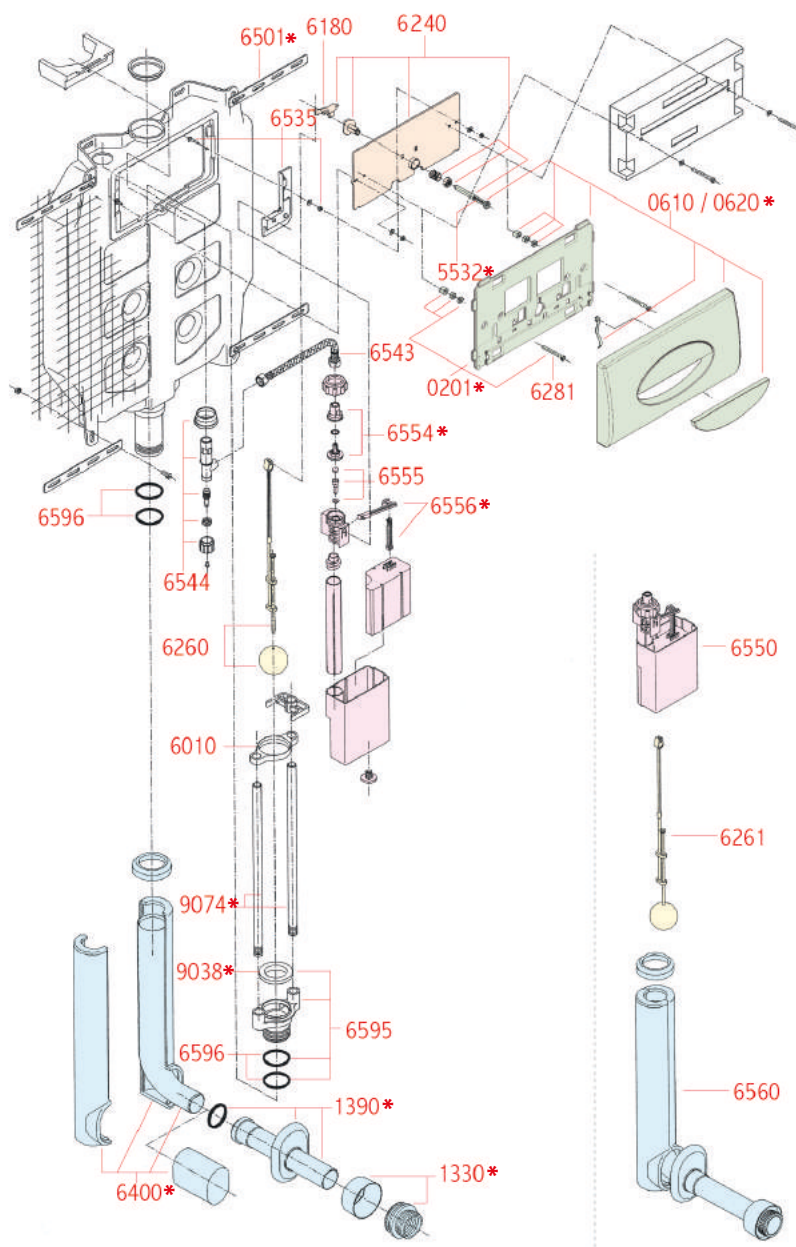

* DISPONIBILE SU RICHIESTA

ART. 2229 RICAMBI ORIGINALI PUCCI ECO/PUCCI ECO ORIGINAL SPARE PARTS

Codice GT <i>Code GT</i>	Codice Pucci <i>Code Pucci</i>	Descrizione	Conf. <i>Pack</i>	€ cad. <i>€ each</i>
0180644	0211	Sportello completo 2 viti registro M8	1	44,00
0180502	0520	Placca Eco bianca completa di telaio porta placca	1	35,40
0180635	5250	Gruppo valvola completo	1	30,00
0180636	5533	Serie viti distanziali, vite registro M8 prolungata 7 cm x Eco	1	22,00
0180563	5560	Sfera con tirantino	1	9,60
0180638	5570	Batteria completa con sfera	1	43,30
0180591	6010	Telaio guida	5	1,50
0180613	6281	Vite inox Ø M5 per telaio	10	0,64
0180617	6535	Staffa sostegno valvola con vite e ranella zincata	2	3,21
0180618	6543	Flessibile FF con guarnizioni	1	15,23
0180619	6544	Rubinetto ottone 1/2" con supporto polietilene	1	22,21
0180620	6550	Gruppo valvola completo	1	34,00
0180621	6555	Pistoncino con guarnizione 10x5 mm	10	1,83
0180622	6560	Gruppo completo tubo di cacciata 35 cm canotto 22 cm - rosone eccentrico e morsetto universale bianco	1	22,55
0180623	6595	Sede estraibile con OR 147	1	12,13
0180624	6596	OR 147 per sede estraibile e codulo	8	0,78

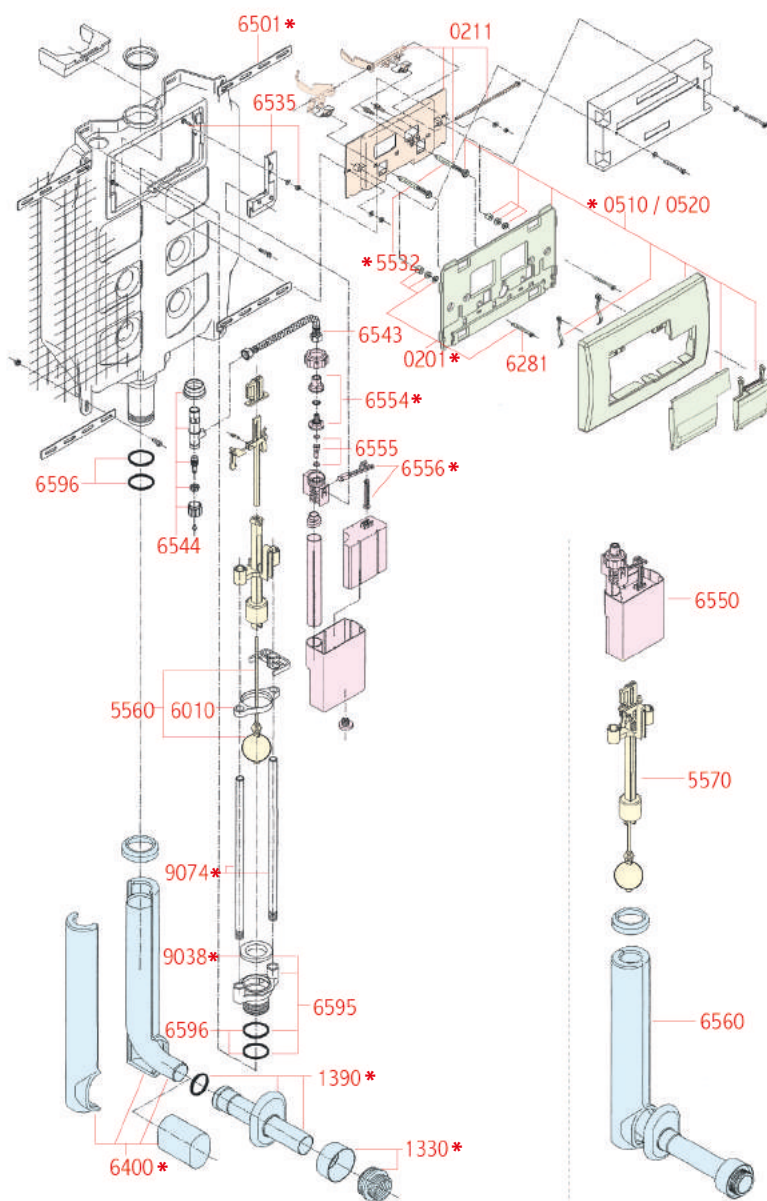

* DISPONIBILE SU RICHIESTA

**ART. 2232 RICAMBI ORIGINALI PUCCI RAME/POLIETILENE 6/8 PRODUZIONE FINO AL 1983
PUCCI ORIGINAL SPARE PARTS PRODUCTION UNTIL 1983 YEAR**

Codice GT <i>Code GT</i>	Codice Pucci <i>Code Pucci</i>	Descrizione	Conf. <i>Pack</i>	€ cad. <i>€ each</i>
0180550	9001	Guarnizione a scodellino	10	0,47
0180552	9002	Membrana a due guarnizioni fibra	10	1,77
0180554	9003	Guarnizione gomma sag. 2,5 mm rame 6/8 DM 7	5	0,88
0180515	9005	Serie guarnizioni con membrana	1	6,75
0180516	9006	Serie guarnizioni con OR	1	6,30
0180558	9016	Dado D/S con guarnizione 3/8"	1	7,78
0180518	9018	Bulloncini 1/4" fissa pulsante al manicotto	10	1,03
0180521	9021	Boccolina interna con OR 119	1	2,29
0180524	9024	Ghiera	5	1,72
0180525	9025	Molle acciaio pulsante basso	5	0,87
0180527	9027	Forcelle funghetti	10	1,72
0180564	9028	Gambetti - dadini - pastiglie cromate	10	3,55
0180562	9030	Serie pulsante	1	8,47
0180566	9032	Boccole cromate fissa rosone	5	2,18
0180568	9033	Rosone e boccola cromata	1	8,81
0180570	9034	Pulsante completo cassetta rame	1	37,90
0180535	9035	Pulsante completo cassetta 6/8	1	25,20
0180536	9041	Raccordino dado D/S, dado, guarnizione 3/8"	1	16,60
0180537	9042	Rubinetto ottone attacco laterale 3/8" 6/8 10 l	1	13,05
0180538	9043	Rubinetto ottone attacco laterale 3/8" 6/8 14 l	1	13,05

Codice GT <i>Code GT</i>	Codice Pucci <i>Code Pucci</i>	Descrizione	Conf. <i>Pack</i>	€ cad. <i>€ each</i>
0180512	9044	Prolunga pulsante 2 cm	1	19,70
0180601	9045	Prolunga pulsante 3 cm	1	20,60
0180602	9046	Prolunga pulsante 4 cm	1	21,65
0180603	9047	Prolunga pulsante 5 cm	1	22,70
0180604	9048	Gambetti prolungati 7 cm dadini - pastiglie	2	4,50
0180539	9051	Astine per galleggiante	5	6,88
0180576	9066	Placca bianca	1	17,75
0180578	9067	Placca nera	1	15,70
0180580	9068	Placca inox	1	22,35
0180630	9069	Placca champagne	1	30,00
0180631	9075	Serie per sportello (viti e dadini)	10	1,66
0180582	9076	Sportello con inserti Ø M5	5	5,40
0180584	9078	Galleggiante in polistirolo	1	4,55
0180541	9080	Rosone cromato	1	7,10
0180632	9081	Pastiglie cromate	10	1,90
0180633	9082	Gambetti e dadini	10	1,80
0180542	9083	Serie guarnizioni (1 sede sfera - 1 membrana - 2 fibra - 1 scodellino)	1	5,40
0180544	9113	Corpo valvola con sede e OR 113	1	13,00
0180545	9114	Valvola attacco laterale	1	19,80
0180547	9141	Rubinetto ottone attacco laterale con dado 1/2" rame 14 l - 6/8 10 l	1	22,00
0180588	9150	Valvola completa attacco laterale	1	31,50

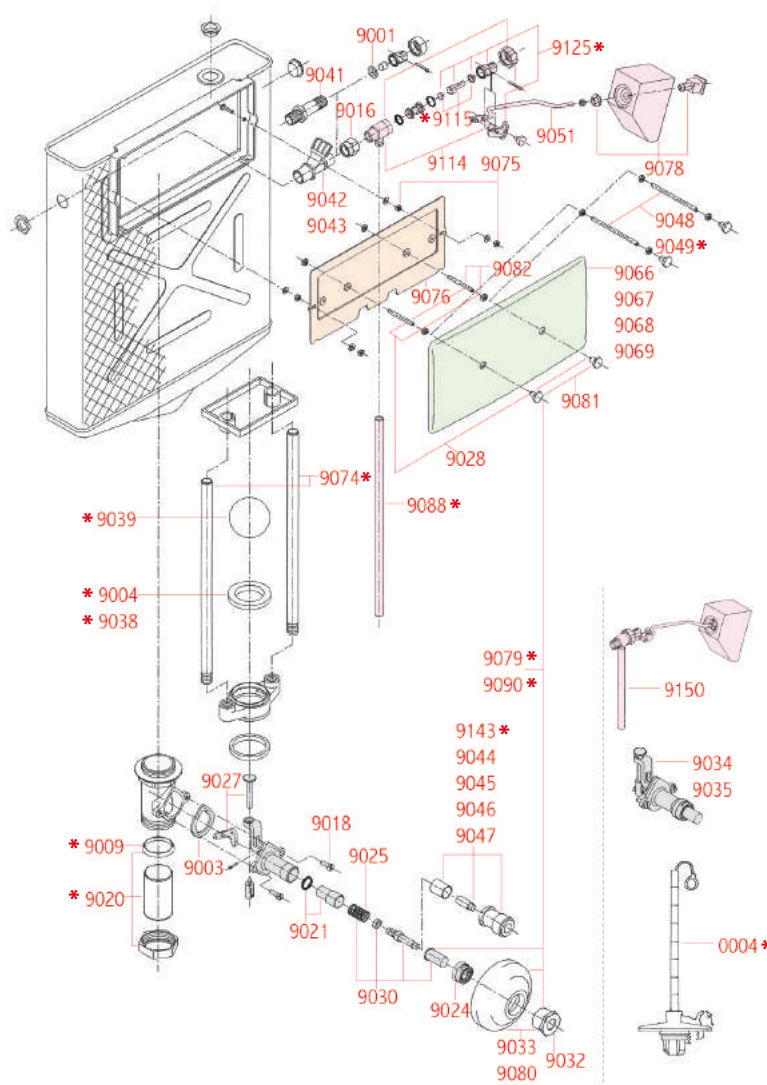

* DISPONIBILE SU RICHIESTA

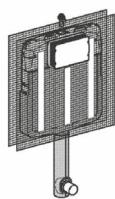

GEBERIT

ART. 2250

Cassetta Unica incasso 9 lt
art. 109.770.00.1.

Codice Code	Conf. Pack	€ cad. € each
0181394	1	215,00



GEBERIT

ART. 2262

Combifix per bidet sospeso
art. 457.600.00.1.

Codice Code	Conf. Pack	€ cad. € each
0181399	1	247,00

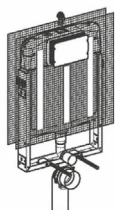

GEBERIT

ART. 2252

Combifix Italia per WC sospeso cassetta 9 lt art. 110.770.00.5.

Codice Code	Conf. Pack	€ cad. € each
0181395	1	340,00

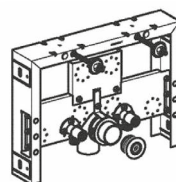

GEBERIT

ART. 2264

Combifix Italia per bidet sospeso
art. 457.608.00.1.

Codice Code	Conf. Pack	€ cad. € each
0181400	1	210,00

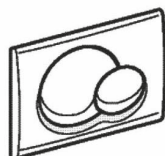

GEBERIT

ART. 2254

Placca Sigma 2 pulsanti bianca
art. 115.770.11.5.

Codice Code	Conf. Pack	€ cad. € each
0181333	1	73,00



BAMPI

ART. 2266

Cassetta WC esterna VELA 2 con galleggiante MAGNETIC, tasto 6/9 lt + tasto 3/4,5 lt.

Exposed cistern with firing valve MAGNETIC button 6/9 lt + button 3/4,5 lt.

Codice Code	colore color	Conf. Pack	€ cad. € each
0181265	bianco	1	85,00

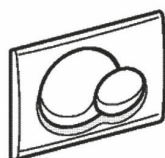

GEBERIT

ART. 2256

Placca Sigma 2 pulsanti cromo
art. 115.770.21.5.

Codice Code	Conf. Pack	€ cad. € each
0181337	1	106,00



BAMPI

ART. 2268

Galleggiante MAGNETIC universale per ridurre la rumorosità delle cassette di scarico esterne dei WC.

Universal flush tank to reduce the noise in the cistern.

Codice Code	Conf. Pack	€ cad. € each
0181260	1	23,60

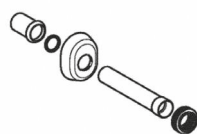

GEBERIT

ART. 2258

Canotto d'allacciamento.

Codice Code	colore color	Conf. Pack	€ cad. € each
0181325	bianco 118.221.11.1	1	26,00
0181326	cromato 118.221.21.1	1	32,00



ANTIODORE
COMBI-SIPHON PLUS

ART. 2269

Sifone ventilato a bottiglia COMBI-SIPHON per eliminare odori cattivi negli scarichi nei bagni e nelle cucine.

Codice Code	Ø	Conf. Pack	€ cad. € each
0161280	32	1	50,00

BAMPI

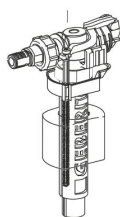

GEBERIT

ART. 2260

Rubinetto galleggiante UNIFILL incasso
art. 240.784.00.1.

Codice Code	Conf. Pack	€ cad. € each
0181433	1	68,00



MINI-VENT

ART. 2271

Valvola di aerazione per bagno e cucina
MINI-VENT.

Codice Code	Conf. Pack	€ cad. € each
0161282	1	52,00

BAMPI



stodini

ART. 2280

Batteria di scarico per WC universale attacco basso.

Low connection universal battery.

Codice Code	Conf. Pack	€ cad. € each
0183250	4	121,80



stodini

ART. 2282

Batteria di scarico per WC universale attacco basso laterale.

Side connection universal battery.

Codice Code	Conf. Pack	€ cad. € each
0183260	4	121,80
0183245	4	127,00

Idem con codolo in ottone/Same with brass shanck



ART. 2282/A

Accessori per monoblocco: tiranti con guarnizione.

Single-block accessories.

Codice Code	Conf. Pack	€ cad. € each
0183251	4	12,00
Guarnizione di fondo		
0183280	10	1,40



stodini

ART. 2284

Rubinetto galleggiante per cassetta con entrata acqua laterale.

Flush tank side water inlet ball cock.

Codice Code	Ø	Conf. Pack	€ cad. € each
0183307	3/8"	4	30,80



stodini

ART. 2286

Rubinetto galleggiante per cassetta con entrata acqua dal fondo.

Flush tank back water inlet ball cock.

Codice Code	Ø	Conf. Pack	€ cad. € each
0183357	3/8"	4	30,80
Idem con codolo ottone/Same with brass shanck			
0183358	3/8"	4	36,50



ART. 2288

Batteria universale di scarico per cassette WC.

WC cistern exhaust universal battery.

Codice Code	Conf. Pack	€ cad. € each
0183360	4	26,00



BETTER

ART. 2290

Galleggiante universale 3/8", attacco lungo in ottone, ingombro soli mm 110.

Universal flush tank.

Codice Code	Conf. Pack	€ cad. € each
0183395	4	7,50

N.B. Adattabile per cassette incasso ed esterne, Geberit, Pucci, Stir blitz, Bampi.



CATIS

ART. 2294

Batteria pneumatica CATIS con pulsante e tubetto.

Push-button and tube CATIS pneumatic battery.

Codice Code	Conf. Pack	€ cad. € each
0202001	CATIS	10
0202003	tipo CATIS	10
Solo sifone/Siphon only		
0202058		4
Solo tubetto c/pulsante		
0202051		4
Solo curva 45°		
0226723		10
Solo rosone		
0224440		10



CATIS

ART. 2296

Batteria "CATIS" Junior.

Junior "CATIS" battery.

Codice Code	Conf. Pack	€ cad. € each
0202004	10	77,00



ART. 2298

Batteria a pulsante elettrica.

Button electric battery.

Codice Code	Conf. Pack	€ cad. € each
0202501		2
Bobina per detta/Battery coil		
0202502		2
Guarnizione per detta/Battery gasket		
0202503		2
Guida/Guide		
0202504		2



ART. 2300

Rubinetto per cassetta con tubetto, rosone e tubo Ø 10 mm.

Washer pipe flush tank cock with chromium-plated brass hexagonal nipples.

Codice Code	Ø	Conf. Pack	€ cad. € each
0183397	3/8"x3/8"	10	8,40
0183398	1/2"x3/8"	10	7,50



ART. 2302

Rubinetto per cassetta in ottone cromato.

Chromium plated brass flush tank cock.

Codice Code	Ø	Conf. Pack	€ cad. € each
1121507	3/8"	10	7,50

**ART. 2304**

Rubinetti a galleggiante "CATIS".
"CATIS" float valve.

Codice Code	Ø	Conf. Pack	€ cad. € each
0201207	3/8"	10	8,70
0201208	1/2"	10	11,30

**ART. 2316**

Rubinetti a galleggiante regolabile silenzioso asta piatta sede inox completo di tubo di carico.
Stainless steel Seat flat rod ball cock.

Codice Code	Ø	Conf./Pack	€ cad. € each
0200508	1/2"	10 30	16,00
0200509	3/4"	10 30	20,70
0200510	1"	10 30	22,30
0200511	1"1/4	6 10	63,30
0200512	1"1/2	4 10	67,55
0200513	2"	2 5	91,00

**ART. 2306**

Rubinetti a galleggiante tipo "CATIS".
Float valve similar to CATIS.

Codice Code	Ø	Conf. Pack	€ cad. € each
0201257	3/8"	10	6,50
0201258	1/2"	10	7,50

**ART. 2308**

Rubinetti a galleggiante 5 coppie asta tonda in ottone.
5 split pins float valve in brass.

Codice Code	Ø	Conf./Pack	€ cad. € each
0200807	3/8"	10 100	8,05
0200808	1/2"	10 100	8,50

**ART. 2318**

Rubinetti a galleggiante regolabile silenzioso sede in resina acetica.
Stainless steel seat silent adjustable ball cock.

Codice Code	Ø	Conf./Pack	€ cad. € each
0200527	3/8"	10 100	8,30
0200528	1/2"	10 100	9,30
Sfera x detto			
0205590	90	10	0,66

**ART. 2310**

Rubinetti a galleggiante 5 coppie asta piatta in ottone.
5 split pins float valve in brass with flat rod.

Codice Code	Ø	Conf./Pack	€ cad. € each
0200859	3/4"	10 50	10,80
0200860	1"	10 50	15,20

**ART. 2312**

Rubinetti a galleggiante 5 coppie con asta piatta sede ottone pesante.
5 Split pins float valve with flat rod.

Codice Code	Ø	Conf./Pack	€ cad. € each
0200809	3/4"	10 50	12,30
0200810	1"	10 30	17,80
0200811	1"1/4	6 10	36,00
0200812	1"1/2	4 10	45,50
0200813	2"	2 5	66,40

IMPORT

0200819	3/4"	10	10,30
0200820	1"	10	15,40

**ART. 2320**

Rubinetti a galleggiante regolabile silenzioso per alte pressioni asta piatta sede inox completo di tubo di carico.
Adjustable noiseless float valve in brass for high pressure with float rod and inlet pipe.

Codice Code	Ø	Conf./Pack	€ cad. € each
0200559	3/4"	10 30	34,90
0200560	1"	10 30	36,70
0200561	1"1/4	10 10	69,00
0200562	1"1/2	4 10	71,00
0200563	2"	2 5	114,00

TIPO PESANTE
SEDE OTTONE**ART. 2313**

Rubinetti a galleggiante 5 coppie con asta piatta sede inox pesante.
5 split pins float tap with flat rod in bronze, bronze seat.

Codice Code	Ø	Conf./Pack	€ cad. € each
0200709	3/4	10 50	13,00
0200710	1"	10 30	18,40
0200711	1"1/4	6 10	36,50
0200712	1"1/2	4 10	46,10
0200713	2"	2 5	67,00
0200814	2"1/2	1 1	198,00
0200815	3"	1 1	215,00
0200816	4"	1 1	370,00

TIPO PESANTE
SEDE INOX**ART. 2323**

Rubinetti a galleggiante silenzioso in ottone asta regolabile curva per cassetta a zaino. Cappuccio ottone sede resina acetica.

Noiseless float valve in brass, adjustable curved rod.

Codice Code	Ø	Conf./Pack	€ cad. € each
0200517	3/8"	10 50	7,80
0200518	1/2"	10 50	8,70



ART. 2324

Rubinetti a galleggiante regolabile silenzioso sede ottone asta inox per cassetta "PUCCI".
"PUCCI" flush tank ball cock.

Codice Code	Ø	Conf./Pack		€ cad. € each
0184807	3/8"	10	100	6,40
Sfera x detto				
0205590	90	10		0,66



ART. 2326

Rubinetti a galleggiante regolabile silenzioso sede nylon asta inox per cassetta "DORA".
"DORA" flush tank ball cock.

Codice Code	Ø	Conf./Pack		€ cad. € each
0184857	3/8"	10	50	13,60
Sfera x detto				
0205590	90	10		0,66



ART. 2328

Rubinetti a galleggiante tipo Sicilia fil. 5/16 completo di tubo scarico.

5/16 thread Sicily type ball cock provided with exhaust pipe.

Codice Code	Ø	Conf./Pack		€ cad. € each
0201008	1/2"	10	100	11,20
0201009	3/4"	10	100	12,40
0201010	1"	10	50	17,60
Sfera x detto 5/16				
0205949	1/2"-3/4"-120	10		2,00
0205951	1"-150	10		3,40

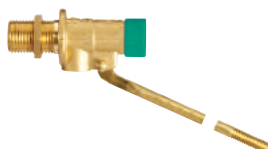

ART. 2330

Rubinetti a galleggiante silenzioso tipo inglese in ottone stampato per basse pressioni sede ottone.

Low pressure noiseless float tap in brass, English type.

Codice Code	Ø	Conf./Pack		€ cad. € each
0201108	1/2"	10	100	10,10
0201109	3/4"	10	50	11,20
0201110	1"	10	50	16,20
Sfera x detto 5/16				
0205949	1/2"-3/4"-120	10		2,00
0205951	1"-150	10		3,40



IN ACCIAIO INOX

ART. 2332

Valvola a galleggiante in acciaio inox 304 completo di sfera in acciaio inox (1"1/2 AISI 316).

Float valve in stainless steel equipped with stainless steel ball.

Codice Code	Ø	Conf. Pack	€ cad. € each
0200828	1/2"	1	72,00
0200829	3/4"	1	142,00
0200830	1"	1	147,00
0200831	1"1/4	1	155,00
0200832	1"1/2	1	470,00



ART. 2334

Sfera in plastica 5/16 per art. 2328/2330.
Plastic ball 5/16 for art. 2328/2330.

Codice Code	Ø	Conf. Pack	€ cad. € each
0205949	1/2"-3/4"-120	10	2,00
0205951	1"-150	10	3,40



ART. 2336

Sfera tonda in plastica c/nottolino in ottone.

Brass pallet round ball.

Codice Code	Ø	Conf. Pack	€ cad. € each
0205790	90	10	0,92



ART. 2338

Sfera in plastica con scorrevole.

Slide plastic ball.

Codice Code	Ø	Conf. Pack	€ cad. € each
0205909	120	10	2,00
0205910	150	10	3,15
0205911	180	10	3,60
0205912	220	10	7,60



PVC PER CATIS

ART. 2340

Sfera in plastica con nottolino in ottone piatta.

Brass flat plastic ball provided with pallet.

Codice Code	Ø	Conf. Pack	€ cad. € each
0205590	90	10	0,66
0205591	catiss originale	10	0,90



RAME

ART. 2342

Sfera tonda in rame saldata con nottolino.

Welded copper round ball provided with pallet.

Codice Code	Ø	Conf. Pack	€ cad. € each
0205308	90	10	6,25



RAME

ART. 2344

Sfera tonda in rame saldata con reggisfera.

Welded copper round ball provided with pallet.

Codice Code	Ø	Conf. Pack	€ cad. € each
0205309	3/4"-120	10	13,20
0205310	1"-150	10	18,90
0205311	1"1/4-180	4	27,50
0205312	1"1/2-200	4	34,00
0205313	2"-220	2	45,20
0205315	3"-300	1	102,00



ART. 2350

Anello inox copri sifoni.
Siphon-cover stainless steel ring.

Codice Code	Ø	Conf. Pack	€ cad. € each
0166113	130	10	2,10



ART. 2352

Tappo espansione per sifoni a pavimento con ombrello inox.
Floor siphon expansion cap provided with a stainless steel protection.

Codice Code	Tappo	Ombrello	€ cad. € each
0165509	90	mm. 125	3,90
0165510	100	mm. 125	3,10



ART. 2354

Pilettoni pavimento con scarico diritto quadro con attacco filettato 1"1/4.
Square straight outlet floor drain provided with 1"1/4 screw connection.



Codice Code	Ø	Conf. Pack	€ cad. € each
0165250	100x100	10	19,00

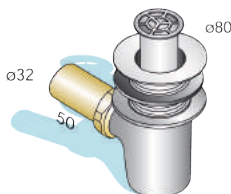

ART. 2358

Pozzetto sifonato Ø 80 per piatti doccia con codulo diritto Ø 32 mm.
Shower siphon drain with straight shank.



Codice Code	Ø	Conf. Pack	€ cad. € each
0165408	80	10	28,00



ART. 2360

Piletta rasata filettata con calotta e codulo.
Smooth threaded drain provided with cap and shank.

Codice Code	Ø	Conf. Pack	€ cad. € each
0161060	1"	10	22,30
0161061	1"1/4	10	29,30



ART. 2362

Piletta tipo svizzero con filetto.
Swiss-type threaded drain.

Codice Code	Ø	Conf. Pack	€ cad. € each
0160910	1"	10	17,00
0160911	1"1/4	10	26,00



XLIRA

ART. 2363

Sifone salvaspazio per lavabo raccordo 1"-1"1/4 tubo scarico Ø 32-40
originale LIRA.
Space-saver trap for wash basin-connection pipe 1"-1"1/4 drain pipe Ø 32-40.

Codice Code	Ø	Conf. Pack	€ cad. € each
0161133		10	15,00



XLIRA

ART. 2364

Sifone salvaspazio per lavelli a 1 vasca
originale LIRA.
Space-saver trap 1 for sink with one bowl.

Codice Code	Ø	Conf. Pack	€ cad. € each
0161112	1"1/2	5	16,30



XLIRA

ART. 2366

Sifone salvaspazio per lavelli a 2 vasche
originale LIRA.
Space-saver trap 2 for sinks with two bowls.

Codice Code	Ø	Conf. Pack	€ cad. € each
0161122	1"1/2	5	23,50



ART. 2367

Riduzione in moplen MF.
MF moplen reducer.

Codice Code	Ø	Conf. Pack	€ cad. € each
0168000	1"1/4x1"1/2	10	0,35
0168001	1"1/2x1"1/4	10	0,35



ART. 2369

Riduzione in ottone cromato per lavelli.
Sink chromium-plated brass reducer.

Codice Code	Ø MF	Conf. Pack	€ cad. € each
0168111	1"x1"1/4	10	3,00
0168112	1"1/4x1"1/2	10	4,40

Codice Code	Ø FM	Conf. Pack	€ cad. € each
0168114	1"x1"1/4	10	4,00
0168113	1"1/4x1"1/2	10	4,90

**ART. 2370**

Sifone una via in polietilene senza piletta, tubo PP 20cm.
Polyethylene siphon without the drain.

Codice Code	Ø	Conf. Pack	€ cad. € each
0160151	1"1/4x32	10	4,42
0160112	1"1/2x40	10	5,20

**ART. 2372**

Sifone due vie in polietilene senza piletta, tubo PP 20cm.
Polyethylene siphon without the drain.

Codice Code	Ø	Conf. Pack	€ cad. € each
0160251	1"1/4x32	10	6,30
0160213	1"1/2x40	5	8,60

**ART. 2374**

Sifone in polietilene per lavelli, un bacino con attacco lavatrice s/piletta, tubo PP 20cm.
Sink polyethylene siphon provided with a basin washing-machine attachment without the drain.

Codice Code	Ø	Conf. Pack	€ cad. € each
0162051	1"1/4x32	10	6,10
0162012	1"1/2x32	10	6,20
0162013	1"1/2x40	5	6,80

**ART. 2376**

Sifone in polietilene due bacini con attacco lavatrice s/piletta, tubo PP 20cm.
Polyethylene siphon provided with two basin washing-machine attachment without the drain.

Codice Code	Ø	Conf. Pack	€ cad. € each
0162151	1"1/4x32	10	7,80
0162112	1"1/2x32	10	7,90
0162113	1"1/2x40	5	10,30

**ART. 2382**

Sifone in polipropilene Praktik a una via con tubo PP Ø 40, 2 attacchi lavatrice.
One-way polypropylene siphon provided with Ø 40 PP tube.

Codice Code	Ø	Conf. Pack	€ cad. € each
0164312	1"1/2	10	13,20

**ART. 2384**

Sifone in polipropilene Praktik 2 a due vie con tubo in PP Ø 40, 2 attacchi lavatrice.
Two-way polypropylene siphon provided with Ø 40 PP tube.

Codice Code	Ø	Conf. Pack	€ cad. € each
0164362	1"1/2	10	19,00

**ART. 2386**

Sifone in polipropilene 1 via, tubo in PP 30 cm, Ø 40.
Polypropylene siphon provided with Ø 40 tube.

Codice Code	Ø	Conf. Pack	€ cad. € each
0163904	1"1/2	10	6,00

**ART. 2388**

Sifone in polipropilene 1 via per lavabo, tubo in PP 30 cm, Ø 40.
Sink Ø 40 polypropylene siphon.

Codice Code	Ø	Conf. Pack	€ cad. € each
0163951	1"1/4	10	6,20

**ART. 2390**

Sifone in polipropilene per lavabo e bidet, tubo in PP 30 cm, Ø 40.
Bidet and sink Ø 40 polypropylene siphon.

Codice Code	Ø	Conf. Pack	€ cad. € each
0163991	1"1/4	10	7,60

**ART. 2391**

Piletta in mopen per lavelli inox Ø 70.
Mopen drain for Ø 70 stainless steel sinks.

Codice Code	Ø	Conf. Pack	€ cad. € each
0161002	1"1/2	10	3,45

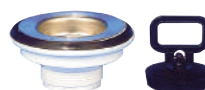
**ART. 2393**

Piletta gattinara per lavelli fire-clay.
Fire-clay sink gattinara drain.

Codice Code	Ø	Conf. Pack	€ cad. € each
0161861	1"1/4	10	1,95
0161862	1"1/2	10	1,95

**ART. 2395**

Piletta in PP Ø 70 per lavelli inox con troppo pieno.
Sink stainless steel mopen drain provided with overflow pipe.

Codice Code	Ø	Conf. Pack	€ cad. € each
0161001	1"1/2	10	4,00

**ART. 2397**

Sifone in polipropilene per doccia orientabile e ispezionabile Ø 80.
Shower Ø 80 jointed polypropylene siphon.

Codice Code	Ø	Conf. Pack	€ cad. € each
0165467	40/50	10	22,00

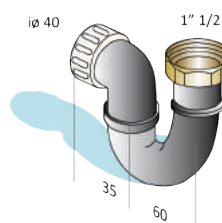
**ART. 2405**

Sifone vasca in PP con uscita orientabile raccordo Ø 40.
Bathtub polypropylene jointed siphon provided with Ø 40 pipe fitting.

Codice Code	Ø	Conf. Pack	€ cad. € each
0163862	1"1/2	10	9,20

**ART. 2401**

Piletta doccia Ø 80 con sifone orientabile in PP Ø 40 ispezionabile.
Shower drain provided with Ø 40 jointed polypropylene siphon.

Codice Code	Ø	Conf. Pack	€ cad. € each
0165470	1"1/2	10	18,60

**ART. 2405/A**

Sifone in polipropilene ribassato per vasca snodato 40/50 orientabile.
Bathtub 40/50 jointed polypropylene siphon.

Codice Code	Ø	Conf. Pack	€ cad. € each
0164123	1"1/2	10	9,00

ART. 2406

Piletta vasca Ø 70 comando a cavo con troppo pieno in PP, parti a vista in ottone cromato.
Bathtub coloumn with overflow pipe.

Codice Code	Ø	Conf. Pack	€ cad. € each
0164052	1"1/2	10	32,00

**ART. 2407**

Piletta vasca Ø 70 con tappo e catenella con troppo pieno in PP, griglia in acciaio.
Bathtub coloumn.

Codice Code	Ø	Conf. Pack	€ cad. € each
0163712	1"1/2	10	9,00

**ART. 2410**

Set per doccia a pavimento completo di griglia quadra 105x105 mm "Letto Sottile"

Codice Code	foglio	Conf. Pack	€ cad. € each
0165503	50x50 cm	1	68,00



NEW

**ART. 2411**

Set per doccia a pavimento completo di griglia pesante quadra 110x110 mm.

Codice Code	foglio	Conf. Pack	€ cad. € each
0165501	50x50 cm	1	68,00

**ART. 2413**

Set per doccia a pavimento in ABS completo di griglia lineare inox L 700 mm.

Codice Code	foglio	Conf. Pack	€ cad. € each
0165502	100x50 cm	1	155,00

**ART. 2403**

Piletta doccia Ø 80 con griglia inox e con sifone orientabile ribassato in PP Ø 40.
Flat grid shower drain provided with Ø 40 jointed polypropylene siphon.

Codice Code	Ø	Conf. Pack	€ cad. € each
0164132	1"1/2	10	14,30

ART. 2404

Piletta sifonata per piatto doccia in abs con griglia ABS cromato.
Trap for Ø 90 shower base with abs grid.

Codice Code	Ø	Conf. Pack	€ cad. € each
0165460	90	5	21,00



NEW

**ART. 2404/A**

Piletta sifonata per piatto doccia foro Ø 50 e Ø 60 mm in ABS con griglia ottone cromato.

Codice Code	Ø	Conf. Pack	€ cad. € each
0165461	80 x 1"1/2	1	20,00

ART. 2404/B

Piletta sifonata per piatto doccia foro Ø 90 mm con griglia in ABS cromato.

Codice Code	Ø	Conf. Pack	€ cad. € each
0165462	115x1"1/2	1	23,20



NEW





ABS CROMATO

ART. 2415

Sifone a bottiglia per lavabo in ABS cromato senza piletta tubo cm 25.

Sink cm. 25 chromium-plated ABS bottle-shaped siphon without drain with tube cm 25.

Codice Code	∅	Conf. Pack	€ cad. € each
0160311	1"1/4	10	14,50

**ART. 2431**

Sifone minimalista basso per lavabo in ottone cromato tubo 30 cm.

Codice Code	∅	Conf. Pack	€ cad. € each
0161750	1"1/4x32	1	34,00



ABS CROMATO

ART. 2417

Sifone a S per bidet in ABS cromato senza piletta tubo cm. 25.

Bidet chromium-plated ABS S-shaped siphons without drain with cm. 25 tube.

Codice Code	∅	Conf. Pack	€ cad. € each
0160411	1"1/4	10	14,50

**ART. 2433**

Sifone minimalista alto per lavabo in ottone cromato tubo 30 cm.

Codice Code	∅	Conf. Pack	€ cad. € each
0161711	1"1/4x32	1	39,00



ABS CROMATO

ART. 2419

Sifone a U in ABS cromato per lavabi a colonna senza piletta tubo cm. 25.

Chromium-plated ABS U-shaped for sink pipes without drain with cm. 25 tube.

Codice Code	∅	Conf. Pack	€ cad. € each
0160511	1"1/4	10	14,50

**ART. 2435**

Sifone minimalista quadro per lavabo in ottone cromato tubo 30 cm.

Wash basin minimum trap pipe 30 cm.

Codice Code	∅	Conf. Pack	€ cad. € each
0161730	1"1/4x32	1	44,00

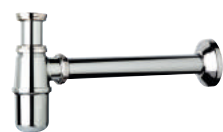
**ART. 2420**

Sifone a bottiglia per lavabo in ottone cromato senza piletta tubo cm. 25.

Sink cm. 25 chromium-plated brass bottle-shaped siphon without drain.

Codice Code	∅	Conf. Pack	€ cad. € each
0161460	1"	10	13,20
0161461	1"1/4	10	17,70



PIASTRA BIANCA

ART. 2440

Sifone incasso lavatrice in PP con piastra bianca.

Drain top for embedded washing machine, in PP with white plate.

Codice Code	∅	Conf. Pack	€ cad. € each
0162205	40	10	3,20

**ART. 2424**

Sifone a S per bidet in ottone cromato senza piletta tubo ottone cm. 25.

Bidet chromium-plated brass S-shaped siphons without drain with cm. 25 brass tube.

Codice Code	∅	Conf. Pack	€ cad. € each
0161660	1"	10	13,20
0161661	1"1/4	10	17,70



PIASTRA INOX

ART. 2442

Sifone incasso lavatrice in PP piastra inox.

Washing machine polypropylene inset siphon.

Codice Code	∅	Conf. Pack	€ cad. € each
0162206	40	10	3,80

**ART. 2428**

Sifone a S con ispezione in ottone cromato per lavabi a colonna senza piletta tubo ottone cm. 25.

Chromium-plated brass S-shaped inspection-siphons for sink pipes without drain with cm. 25 brass tube.

Codice Code	∅	Conf. Pack	€ cad. € each
0161260	1"	10	13,20
0161261	1"1/4	10	17,70

**ART. 2444**

Sifone lavatrice in pvc 1".

Washing machine PVC insert.

Codice Code	∅	Conf. Pack	€ cad. € each
c/piastra bianca			
0162201	50-40	10	9,80
c/piastra acciaio			
0162203	50-40	10	10,80

**ART. 2446**

Sifone in ottone cromato per lavatrice Ø 32.
Washing machine chromium-plated brass siphon.

Codice Code		Conf. Pack	€ cad. € each
0162500	ottone	10	14,80

**ART. 2448**

Scarico sifonato esterno per lavatrice - lavastoviglie - Canotto di innesto mm. 25 in ABS.
Washing-machine and dishwasher outer siphon drain pipes with ABS mm. 25 coupling sleeve.

Codice Code		Conf. Pack	€ cad. € each
0162190	abs	10	5,00

**ART. 2450**

Piletta per lavabi e bidet con troppo pieno.
Sink and bidet drain with overflow pipe.

Codice Code	Ø	Conf. Pack	€ cad. € each
0161850	1"	10	8,30
0161851	1"1/4	10	8,60

**ART. 2452**

Piletta gattinara per lavello s/dado con tappo a catenella.
Gattinara drain without nut with chain cap.

Codice Code	Ø	Conf. Pack	€ cad. € each
0161814	1" Ø 63	10	6,70
0161815	1"1/4 Ø 80	10	6,00
0161816	1"1/2 Ø 80	10	7,90

**ART. 2453**

Pilettoni per lavelli in acciaio inox diam. 90 1"1/2 con chiusura e apertura a scattino.

Codice Code		Conf. Pack	€ cad. € each
0161890	STP	10	6,30
0161892	CTP	10	7,50
0161891	solo tappo di ricambio Ø 50	18	5,00

**NEW**

A PRESSIONE

ART. 2455

Piletta automatica per lavabo e bidet CTP (con troppo pieno) e STP (senza troppo pieno). Chiusura e apertura a pressione.

Codice Code		Conf. Pack	€ cad. € each
0161820	CTP Ø 63 x 1"1/4	1	22,50
0161822	STP Ø 63 x 1"1/4	1	22,50

**NEW**

A PRESSIONE

ART. 2455/A

Piletta PESANTE automatica CTP (con troppo pieno). Chiusura e apertura a pressione.

Codice Code	mm	Conf. Pack	€ cad. € each
0161911	70 x 1"1/4	1	22,50

**ART. 2456**

Prolunga per lavatrice in plastica.
Washing machine plastic pipe extension.

Codice Code	Ø	Conf. Pack	€ cad. € each
5242610	1"	4	3,50

**ART. 2458**

Giunto per tubo.
Spout pipe fitting.

Codice Code	Ø	Conf. Pack	€ cad. € each
5242917	17x17	10	0,26
5242918	17x22	10	0,26
5242921	22x22	10	0,26

**ART. 2460**

Curvetta per sifone lavatrice in PP. bianca.

Washing machine siphon PP bent pipe fitting.

Codice Code	Ø	Conf. Pack	€ cad. € each
0162210	1"	10	0,70

**ART. 2462**

Pipa conghiera girevole in PVC per lavatrice.
Washing machine rotating ring nut PVC lug.

Codice Code	Ø	Conf. Pack	€ cad. € each
5242809	3/4"x3/4"	10	2,30

**ART. 2464**

Nipples in ABS.
ABS nipples.

Codice Code	Ø	Conf. Pack	€ cad. € each
5243009	3/4"x3/4"	10	0,27

**ART. 2480**

Canotto in ottone cromato per scarico lavatrice c/raccordo.

Washing-machine drain pipe provided with pipe fitting.

Codice Code	Ø x cm	Conf. Pack	€ cad. € each
0162160	26x250	10	11,00
0162161	30x250	10	11,30
0162162	32x250	10	12,00
0162163	40x250	10	13,00

Solo raccordo portagomma.
Single hose-connector.

0162150	1"	10	2,30
---------	----	----	------



**ART. 2482**

Canotto flessibile per WC in ottone cromato.

WC chromium-plated brass flexible pipe.

Codice Code	Ø x cm	Conf. Pack	€ cad. € each
0226520	26x30	10	5,15
0226525	30x30	10	5,70
0226530	32x30	10	5,80

**ART. 2484**

Curva di scarico WC in ottone cromato Ø 30.

WC chromium-plated brass bent drain pipe.

Codice Code	cm		Conf. Pack	€ cad. € each
0226723	45°	24	10	4,60
0226730	90°	20x30	10	8,20

**ART. 2486**

Canotto con battente in ottone cromato.

Chromium-plated brass tube with buffer.

Codice Code	Ø x cm	Conf. Pack	€ cad. € each
0226924	24x25	10	3,00
0226926	26x25	10	2,80
0226930	30x25	10	3,10
0226932	32x25	10	3,20
0226940	40x25	10	5,20

**ART. 2488**

Canotto con battente dado e guarnizioni in ottone cromato.

Buffer, nut and ring chromium-plated brass tube.

Codice Code	Ø x cm	Conf. Pack	€ cad. € each
0227026	26x25	10	4,50
0227030	30x25	10	5,00
0227032	32x25	10	5,50

**ART. 2500**

Tubo ottone cromato liscio.

Polished chromium-plated brass tube.

Codice Code	Ø x cm	Conf. Pack	€ cad. € each
0227119	24x25	10	2,72
0227120	26x30	10	2,90
0227125	30x30	10	3,15
0227130	32x30	10	3,30
0227140	40x30	10	5,40
0227326	26x100	1	10,30
0227330	30x100	1	11,00
0227332	32x100	1	11,50

**ART. 2502**

Eccentrico con rosone in ottone.

Brass washer cam.

Codice Code	Ø	Conf. Pack	€ cad. € each
0220330	30	10	12,00
0220332	32	10	13,00

**ART. 2504**

Prolunga per canotto in ottone cromato c/Oring.

Chromium-plated brass tube extension provided with Oring.

Codice Code	Ø x cm	Conf. Pack	€ cad. € each
0227386	26x120	10	2,80
0227388	30x120	10	3,10
0227390	32x120	10	3,30

**ART. 2506**

Giunzione in ottone cromato con 2 Oring.

Chromium-plated brass tube extension provided with Oring.

Codice Code	Ø	Conf. Pack	€ cad. € each
0227226	26	10	2,80
0227230	30	10	3,10
0227232	32	10	3,30
0227240	40	10	4,00

**ART. 2507**

Giunzione ridotta in ottone cromato con 2 Oring. in gomma.

Chromium-plated brass tube extension provided with Oring.

Codice Code	Ø	Conf. Pack	€ cad. € each
0227259	26x32	10	3,35
0227260	32x40	10	3,78

**ART. 2508**

Manicotto ridotto cromato con Oring in gomma

Codice Code	Ø	Conf. Pack	€ cad. € each
0227200	32x26	10	3,40
0227202	40x32	10	3,80

**ART. 2510**

Raccordo di collegamento piombo-PVC in polipropilene.

Plypropylene lead-PVC coupling.

Codice Code	Ø	Conf. Pack	€ cad. € each
1070102	32x32	10	4,40
1070103	35x40	10	4,50



ART. 2512

Rosone a scatola con foro ovale per curva 45°.
Oval hole box washer for a 45° curve.

Codice Code	Ø	Conf. Pack	€ cad. € each
0224440	40x80	10	1,50



ART. 2514

Rosetta apribile in plastica bianca.
Single-hole washers with plastic washers.

Codice Code	Ø	Conf. Pack	€ cad. € each
0224510	10	100	0,14
0224512	12	100	0,14
0224514	14	100	0,14
0224516	16	100	0,14
0224518	3/8"x18	100	0,14



ART. 2516

Rosetta plastica bianca per tubi rame.
Copper tube white plastic washers.

Codice Code	Ø	Conf. Pack	€ cad. € each
0224599	Dal Ø 8 al 16 <i>From Ø 8 to 16</i>	100	0,14

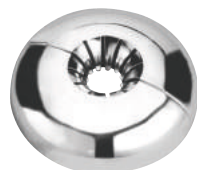

ART. 2518

Rosetta plastica universale cromata.
Plastic Chromed universal flange.

Codice Code	Ø	Conf. Pack	€ cad. € each
0224590	Dal Ø 10 al 22 <i>From Ø 10 to 22</i>	100	0,70



ART. 2520

Rosetta in ottone cromato.
Chromium-plated brass washers.

Codice Code	Ø	Conf. Pack	€ cad. € each
0224307	3/8"	100	0,50
0224308	1/2"	100	0,50
0224309	3/4"	100	0,92



ART. 2522

Rosetta apribile in ottone cromato.
Washers which can be opened.

Codice Code	Ø	Conf. Pack	€ cad. € each
0224607	3/8"	100	1,28
0224608	1/2"	100	1,28
0224609	3/4"	100	1,70



ART. 2524

Cappuccio in ottone cromato.
Brass chromed cap.

Codice Code	Ø	Conf. Pack	€ cad. € each
1105599	64x41	10	8,60



ART. 2526

Rosoni per canotti in ottone cromati H-76.
Brass tube washers.

Codice Code	Ø	Conf. Pack	€ cad. € each
0224726	26	10	1,00
0224730	30	10	1,00
0224732	32	10	1,00



ART. 2528

Rosone in ottone cromato a scatola.
Box chromium-plated brass washers.

Codice Code	Ø	Conf. Pack	€ cad. € each
0224507	26	10	2,90
0224508	30	10	2,90
0224509	32	10	2,90



ART. 2530

Rosetta esagonale.
Hexagonal head washer.

Codice Code	Ø	Conf. Pack	€ cad. € each
0225008	1/2"	100	0,38



ART. 2532

Borchia copritubo universale in PVC per radiatori singola.
Universal pipe-cover for radiators, single.

Codice Code	Ø	Conf. Pack	€ cad. € each
0225050	8/16"	100	0,32



ART. 2534

Borchia copritubo universale in PVC per monotubo doppio.
Universal pipe-cover for double mono-pipe.

Codice Code	Ø	Conf. Pack	€ cad. € each
0225060	8/16"	100	0,80

**ART. 2536**

Tubo flessibile in mat. plastico rotoli da mt. 20.
Plastic material flexible tube which is available in mt. 20 rolls.

Codice Code	Ø	DN	Conf. Pack	€ al mt € elnet
3263011	1"	32	2	2,70
3263012	1 1/4"	40	2	3,50

**ART. 2538**

Manicotto in PVC.
PVC coupling.

Codice Code	tubo Ø	term Ø	Conf. Pack	€ cad. € each
3263232	32	26	10	0,95
3263233	32	32	10	0,96
3263240	40	40	10	0,97

**ART. 2540**

Manicotto con calotta in ottone girevole.
Rotating brass cap coupling.

Codice Code	Ø	Conf. Pack	€ cad. € each
3263410	1"x32	10	2,38
3263411	1"x1/4x32	10	2,40
3263412	1"x1/2x40	10	2,42

**ART. 2542**

Tubo estensibile da cm. 30 sino a cm. 80 con ghiera in ottone.
Extensible tube which ranges between cm. 30 to cm. 80.

Codice Code	Ø	Conf. Pack	€ cad. € each
3264008	26x1"	10	1,73
3264009	32x1"	10	1,90
3264010	32x1 1/4"	10	1,90
3264011	40x1 1/2"	10	2,00

**CROMATO****ART. 2544**

Tubo estensibile da cm. 30 sino a cm. 80 cromato con rosone.
Chromium-plated extensible tube which ranges between cm. 30 to cm. 80.

Codice Code	Ø	Conf. Pack	€ cad. € each
3264016	32x1"	10	5,55
3264017	32x1 1/4"	10	5,60
3264018	40x1 1/2"	10	5,70

**ART. 2550**

Tubo flessibile carico lavatrice in acciaio FF 3/4".

Washing machine FF 3/4" steel flexible drain pipe.

Codice Code	cm	Conf. Pack	€ cad. € each
3260610	100	10	10,00
3260615	150	10	11,80
3260620	200	10	13,20

**ART. 2552**

Tubo carico lavatrice in acciaio FF 3/4" con curvetta.

Washing machine FF 3/4" drain pipe with bent pipe fitting.

Codice Code	cm	Conf. Pack	€ cad. € each
3260210	100	10	13,00
3260215	150	10	14,30
3260220	200	10	16,00

**ART. 2554**

Tubo in gomma per carico lavatrice FF 3/4".

Washing machine FF 3/4" rubber drain pipe.

Codice Code	cm	Conf. Pack	€ cad. € each
3260815	150	10	2,65
3260820	200	10	3,05
3260830	300	10	4,30

**ART. 2556**

Tubo in gomma per carico lavatrice con curvetta.

Washing machine rubber drain pipe with bent pipe fitting.

Codice Code	cm	Conf. Pack	€ cad. € each
3260865	150	10	2,90
3260870	200	10	3,30
3260880	300	10	4,60

**ART. 2558**

Tubo per scarico lavatrice spiralato con curvetta.

Washing machine coiled drain pipe provided with bent pipe fitting.

Codice Code	cm	Conf. Pack	€ cad. € each
3261015	150	10	2,55
3261020	200	10	2,90
3261030	300	10	3,70

**ART. 2560**

Flessibile in materiale plastico per scarico lavatrice estensibile da cm. 70 sino a 200 o 300.

Washing machine plastic material drain flexible pipe which ranges between cm. 70 and 200 or 300.

Codice Code	cm	Conf. Pack	€ cad. € each
3261050	70-200	10	3,00
3261051	80-300	10	3,50



ART. 2562

Flessibile inox MF.
MF stainless steel flexible pipe.

Codice Code	cm 25	Conf. Pack	€ cad. € each
0240601	1/2"x1/2"	25	3,00
0240602	1/2"x3/8"	25	2,65
0240603	3/8"x3/8"	25	2,62
0240604	3/8"x1/2"	25	2,90
cm 30			
0240611	1/2"x1/2"	25	3,10
0240612	1/2"x3/8"	25	2,85
0240613	3/8"x3/8"	25	2,80
0240614	3/8"x1/2"	25	3,05
cm 35			
0240621	1/2"x1/2"	25	3,35
0240622	1/2"x3/8"	25	3,00
0240623	3/8"x3/8"	25	3,00
0240624	3/8"x1/2"	25	3,25
cm 40			
0240631	1/2"x1/2"	25	3,35
0240632	1/2"x3/8"	25	3,20
0240633	3/8"x3/8"	25	3,15
0240634	3/8"x1/2"	25	3,40
cm 50			
0240641	1/2"x1/2"	25	3,70
0240642	1/2"x3/8"	25	3,50
0240643	3/8"x3/8"	25	3,50
0240644	3/8"x1/2"	25	3,75



ART. 2568

Flessibile inox MF c/ nipples lungo.
Long stainless steel flexible pipe with nipples.

Codice Code	cm 25	Conf. Pack	€ cad. € each
0240801	1/2"x1/2"	25	3,35
0240802	1/2"x3/8"	25	3,25
0240803	3/8"x3/8"	25	3,30
0240804	3/8"x1/2"	25	3,50
cm 30			
0240811	1/2"x1/2"	25	3,70
0240812	1/2"x3/8"	25	3,40
0240813	3/8"x3/8"	25	3,45
0240814	3/8"x1/2"	25	3,65
cm 35			
0240821	1/2"x1/2"	25	4,05
0240822	1/2"x3/8"	25	3,55
0240823	3/8"x3/8"	25	3,60
0240824	3/8"x1/2"	25	3,82
cm 40			
0240831	1/2"x1/2"	25	4,00
0240832	1/2"x3/8"	25	3,70
0240833	3/8"x3/8"	25	3,75
0240834	3/8"x1/2"	25	4,00
cm 50			
0240841	1/2"x1/2"	25	4,15
0240842	1/2"x3/8"	25	4,00
0240843	3/8"x3/8"	25	4,00
0240844	3/8"x1/2"	25	4,30



ART. 2564

Flessibile inox FF.
FF stainless steel flexible pipe.

Codice Code	cm 25	Conf. Pack	€ cad. € each
0240701	1/2"x1/2"	25	3,00
0240708	1/2"x3/8"	25	2,65
0240703	3/8"x3/8"	25	2,40
cm 30			
0240711	1/2"x1/2"	25	3,10
0240712	1/2"x3/8"	25	2,80
0240713	3/8"x3/8"	25	2,55
cm 35			
0240721	1/2"x1/2"	25	3,20
0240722	1/2"x3/8"	25	3,00
0240723	3/8"x3/8"	25	2,75
cm 40			
0240731	1/2"x1/2"	25	3,20
0240732	1/2"x3/8"	25	3,15
0240733	3/8"x3/8"	25	2,90
cm 50			
0240741	1/2"x1/2"	25	3,70
0240742	1/2"x3/8"	25	3,50
0240743	3/8"x3/8"	25	3,25



ART. 2570

Flessibile inox MF 1/2"x1/2" gigante per scaldabagno.
Water heater very large MF 1/2"x1/2" stainless steel flexible pipe.

Codice Code	cm	Conf. Pack	€ cad. € each
0241025	25	25	4,20
0241030	30	25	4,45
0241035	35	25	4,70
0241040	40	25	5,15
0241050	50	25	5,60



ART. 2572

Flessibile acciaio zincato antivibranti MF per acqua fredda e calda sino a 80° sede piana.
Flat seat MF vibration-damping flexible pipes for cold and hot water up to 80°.

Codice Code	cm 30	Conf. Pack	€ cad. € each
0240208	1/2"	10	4,35
0240209	3/4"	10	6,40
0240210	1"	10	8,95
0240211	1"1/4	5	18,20
0240212	1"1/2	5	26,10
0240213	2"	5	40,50
cm 40			
0240218	1/2"	10	4,90
0240219	3/4"	10	7,20
0240220	1"	10	10,00
0240221	1"1/4	5	19,70
0240222	1"1/2	5	28,20
0240223	2"	5	43,30
cm 50			
0240248	1/2"	10	5,30
0240249	3/4"	10	7,80
0240250	1"	10	10,80
0240251	1"1/4	5	21,20
0240252	1"1/2	5	30,10
0240253	2"	5	46,00
cm 60			
0240268	1/2"	10	5,70
0240269	3/4"	10	8,60
0240270	1"	10	11,80
0240271	1"1/4	5	22,70
0240272	1"1/2	5	32,30
0240273	2"	5	49,00

ART. 2566

Flessibile 1" MF con curvetta per elettropompe.
MF stainless steel flexible pipe with elbow for pump.

Codice Code	cm	Conf. Pack	€ cad. € each
0240405	50	10	15,40
0240410	100	10	21,00

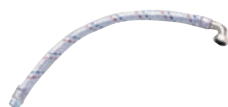



SANISPLIT

L'UNICA CASSETTA TRITURATRICE CON MECCANISMO ESTRAIBILE SENZA TUBI A VISTA O CON COLLEGAMENTO ESTERNO

SANISPLIT è una cassetta in plastica composta da una prima unità di raccolta delle acque fissata in modo permanente al WC e da una seconda unità, **estraibile**, contenente i meccanismi necessari al funzionamento.

La raccolta delle acque avviene in una vasca in gomma EPDM resistente agli acidi, ai grassi ed alle alte temperature.









Il meccanismo di triturazione è costituito da un motore, alimentato a 220 V e da una pompa centrifuga, nella cui girante sono inserite alcune lame di acciaio. **Le due parti, come detto, sono divisibili.**

La separazione dell'unità estraibile avviene con una semplice operazione eseguibile direttamente dallo stesso utilizzatore. In effetti in casi di intasamento, bloccaggio o guasto meccanico, il nostro **Split System** consente di separare l'unità estraibile dalla unità idraulica fissa, evitando in tal modo di dover scollegare sia il WC che le tubazioni di raccolta e di scarico delle acque.

SANISPLIT ha un sistema di collegamento idraulico tutto interno che consente la scomparsa di tutti quei tubi, raccordi e fascette che compromettono l'estetica di un locale da bagno.

SANISPLIT è omologato per una prevalenza in verticale di oltre 10 metri e per una capacità di evacuazione di oltre 300 l/min.
È possibile scaricare le acque della lavatrice e della lavastoviglia, con temperature fino a 100°C.

ART. 2574

Codice Code	TIPOLOGIA DEGLI APPARECCHI									€ cad. € each
4201051	SANISPLIT 1	●								750,00
4201052	SANISPLIT 2	●	●				●	●	●	795,00
4201053	SANISPLIT 3	●	●	●	●	●	●	●	●	940,00
4201054	SANISPLIT K2		●				●	●	●	800,00



PER FLANGE

ART. 2620

Guarnizione per flange PN 10 - PN 16 esente amianto spessore mm. 2 a norma. PN 10 - PN 16 mm. 2 thick flange rings without asbestos.

Codice Code	DN	mm	Conf. Pack	€ cad. € each
1145101	20	60x25	100	0,22
1145102	25	70x30	100	0,31
1145103	32	82x42	100	0,39
1145104	40	92x49	100	0,50
1145105	50	107x57	100	0,71
1145106	65	127x76	50	0,96
1145108	80	142x89	50	1,20
1145110	100	162x108	50	1,53
1145112	125	192x133	20	2,22
1145115	150	218x159	10	2,66
1145120	200	273x200	10	3,66



PER FLANGE

ART. 2622

Guarnizioni per flange in gomma tela spessore mm. 3.
mm. 3 thick rubberised canvas flange rings.

Codice Code	DN	mm	Conf. Pack	€ cad. € each
1145201	20	60x25	100	0,18
1145202	25	70x30	100	0,21
1145203	32	82x42	100	0,27
1145204	40	92x49	100	0,30
1145205	50	107x57	100	0,34
1145206	65	127x76	50	0,53
1145208	80	142x89	50	0,69
1145210	100	162x108	50	0,87
1145212	125	192x133	20	1,08
1145215	150	218x159	10	1,24
1145220	200	273x200	10	2,30

**ART. 2624**

Guarnizioni in gomma per rubinetti s/foro.

Rubber rings for taps without holes.

Codice Code	rubex Ø	Conf. Pack	€ x 100 pz
0074207	3/8"	100	14,70
0074208	1/2"	100	16,20

**ART. 2626**

Guarnizioni in gomma per rubinetti c/foro.

Rubber rings for pierced taps.

Codice Code	rubex Ø	Conf. Pack	€ x 100 pz
0074407	3/8"	100	13,40
0074408	1/2"	100	15,00
0074409	3/4"	100	24,50

**ART. 2628**

Guarnizioni in gomma per rubinetti c/foro K2 in NBR.

NBR K2 rubber rings for pierced taps.

Codice Code	K2 Ø	Conf. Pack	€ x 100 pz
0074307	3/8"	100	15,70
0074308	1/2"	100	19,80
0074309	3/4"	100	33,00
0074310	1"	100	41,40

**ART. 2630**

Guarnizioni in fibra per vitoni mm. 1.
Mm. 1 large screw fibre rings.

Codice Code	Ø	Conf. Pack	€ x 100 pz
0077017	16x20	100	4,20
0077018	18x21	100	4,20
0077019	19x23	100	4,20
0077020	20x24	100	5,50
0077021	21x24	100	5,50

**ART. 2636**

Guarnizioni in busta 4 pezzi.
Gasket kit which includes 4 parts.

Codice Code	Ø	Conf. Pack	€ cad. € each
0061108	1/2"	10	1,20
0061109	3/4"	10	1,50
0061110	1"	10	1,50
0061111	1*1/4	10	1,62
0061112	1*1/2	10	1,95

**ART. 2638**

Guarnizioni in gomma piatta.
Flat rubber gasket.

Codice Code	Ø	Conf. Pack	€ x 100 pz
0074607	3/8"	100	22,50
0074608	1/2"	100	23,00
0074609	3/4"	100	30,60
0074610	1"	100	30,80
0074611	1*1/4	100	30,90
0074612	1*1/2	100	31,30

**ART. 2640**

Guarnizioni in gomma con bordino basso.
Small edge rubber gasket.

Codice Code	Ø	Conf. Pack	€ x 100 pz
0074808	1/2"	100	20,30
0074809	3/4"	100	31,00
0074810	1"	100	31,20
0074811	1*1/4 Vasca/Tank	100	58,30
0074812	1*1/2 Sifone/Siphon	100	61,30
0074813	Gattinara ring	100	91,00

**ART. 2642**

Guarnizioni in gomma con bordino alto.
Large edge rubber gasket.

Codice Code	Ø	Conf. Pack	€ x 100 pz
0075008	1/2"	100	27,60
0075009	3/4"	100	50,00
0075010	1"	100	38,60
0075011	1*1/4 Vasca/Tank	100	38,80
0075012	1*1/2 Sifone/Siphon	100	62,00

**ART. 2644**

Anelli o ring.
O Rings.

Codice Code	Ø	Ø interno x corda	€ x 100 pz
0075510	10	12,7x2,70	10,80
0075512	12	15,1x2,70	10,80
0075514	14	18,4x2,70	10,80
0075516	16	19,8x3,60	10,80
0075518	18	23x3,60	14,80
0075520	20	26,9x3,60	14,80
0075522	22	29,3x3,60	18,60



AMIANTITE E GOMMA ASSORTITE

ART. 2645

Scatola guarnizioni miste 180 pezzi assortiti.
Mixed gasket kit which is provided with 180 assorted parts.

Codice Code	Conf. Pack	€ cad. € each
0069001	4	15,00



SOLO O RING

ART. 2645/A

Scatola O-Ring misti 220 pezzi assortiti.
Mixed O-Ring case which is provided with 220 assorted parts.

Codice Code	Conf. Pack	€ cad. € each
0069002	4	20,00



ART. 2646

Guarnizione cilindrica per galleggiante in gomma NR nera anticalcareo resistente al cloro. Diam. est. mm. 19,7 H 11
Ball cock chlorine-resistant NR black anti-calcareous rubber cylindrical ring with mm. 19,7 outer diameter and 11 high.

Codice Code	Conf. Pack	€ cad. € each
0061901	10	0,20



ART. 2648

Guarnizione di tenuta fondo cassetta in gomma NR nera anticalcareo resistente al cloro. Diam. est. mm. 66 Ø 21,5 H 9.
Chlorine-resistant NR black anti-calcareous rubber back flush tank gaskets with mm. 66 Ø 21,5 outer diameter and 9 high.

Codice Code	Conf. Pack	€ cad. € each
0062001	25	0,64



ART. 2650

Morsetto per WC in gomma NR bianca per vaso mm. 50 Adattabile a canotti Ø 26-32
NR white rubber W.C. clamp used for mm. 50 diameter W.C. cisterns. It is suitable for mm. 26, 32 diameter tubes.

Codice Code	mm	Conf. Pack	€ cad. € each
0065001	50	50	0,54



ART. 2652

Guarnizioni in gomma nera per tubi lavatrice.
Washing machine tube black rubber rings.

Codice Code	Ø	Conf. Pack	€ cad. € each
0061759	3/4"	10	0,04



ART. 2654

Morsetto WC in gomma NR bianca mm. 55 per canotti mm. 30.
Mm. 55 NR white rubber W.C. clamp is suitable for mm. 30 diameter tubes.

Codice Code	mm	Conf. Pack	€ cad. € each
0065003	55	50	0,88



ART. 2656

Morsetto universale si adatta ai WC Ø 50-60. Riceve tubi di scarico da Ø 28 a Ø 40.
Universal clamp, can be suited WC Ø 50-60 it receives draining pipes having from Ø 28 to Ø 40.

Codice Code	Ø	Conf. Pack	€ cad. € each
0065004	50-60	50	1,00



ART. 2658

Morsetto tipo standard per WC in gomma NR bianca per vaso mm. 60. Adattabile a canotti Ø 30.
NR white rubber W.C. standard clamp used for mm. 60 diameter W.C. cisterns. It is suitable for mm. 30 diameter tubes.

Codice Code	mm esterno	Conf. Pack	€ cad. € each
0065100	60	50	0,43



ART. 2660

Morsetto in gomma nera per vasi mm. 60. Adattabile a canotti Ø 40/44.
Black rubber clamp used for mm. 55 diameter W.C. cisterns. It is suitable for mm. 40 diameter tubes

Codice Code	mm esterno	Conf. Pack	€ cad. € each
0065055	60	50	0,68



ART. 2662

Morsetto in gomma nera per curve tecniche mm. 40 Adattabile a canotti Ø 26-32.
Black rubber clamp used for mm. 40 diameter technical curves. It is suitable for mm. 26 and 32 diameter tubes.

Codice Code	mm esterno	Conf. Pack	€ cad. € each
0065104	40	50	0,33



ART. 2664

Morsetto in gomma NR nera per curve tecniche mm. 50, lunghezza 36 mm.
NR black rubber clamp used for mm. 50 diameter technical curves.

Codice Code	Adattabile a cannotti Suitable for tube diameters	€ cad. € each
0065140	26-32 1"-1"1/4	0,65
0065144	40-1"1/2	0,60

Conf./Pack 50

**ART. 2666**

Morsetto in gomma NR nera per curve tecniche mm. 47. Adattabili a canotti Ø 26-32.

NR black rubber clamp used for mm. 47 diameter technical curves. It is suitable for mm. 26 and 32 diameter tubes.

Codice Code	mm esterno	Conf. Pack	€ cad. € each
0065311	47	50	0,36

**ART. 2667**

Morsetto in gomma NR nera con oring esterno Ø mm 40 foro 26/32.

NR black rubber clamp with oring used for mm 40 hole 26/32.

Codice Code	mm esterno Loop	Conf. Pack	€ cad. € each
0065313	40	50	1,18



Per WR

ART. 2668

Morsetto in gomma NR nera per curve tecniche mm. 50. Lunghezza mm. 27. Adattabili a canotti Ø 26-32.

NR black rubber clamp used for mm. 50 diameter technical curves. It is suitable for mm. 26 and 35 diameter tubes.

Codice Code	mm esterno	Conf. Pack	€ cad. € each
0065323	50	50	0,48

Per W.R/W.R Type



Per Geberit

ART. 2670

Morsetto in gomma NR nera per curve tecniche mm. 46. Adattabili a canotti Ø 40.

NR black rubber clamp used for mm. 46 diameter technical curves. It is suitable for mm. 40 diameter tubes.

Codice Code	mm esterno	Conf. Pack	€ cad. € each
0065312	46	50	0,28

Per GEBERIT/GEBERIT Type

**ART. 2672**

Sfera in gomma Ø 52.
mm 52 diameter rubber ball.

Codice Code	mm esterno	Conf. Pack	€ cad. € each
0066010	52	10	5,40

Per valvola SIAS/For SIAS valve

**ART. 2674**

Sfera con nottolino ottone filetto M 4 in gomma nera anticalcareo.

Anti-calcareous black rubber M4 thread brass pallet ball.

Codice Code	mm esterno	Conf. Pack	€ cad. € each
0066011	64,5	10	1,86

**ART. 2676**

Sfera in gomma nera anticalcareo. Diam. est. mm. 64 H mm. 43 Ø passante superiore mm. 14.

Anti-calcareous black rubber ball with 64 outer diameter, mm. 43 height and mm. 14 diameter higher loop.

Codice Code	mm esterno	Conf. Pack	€ cad. € each
0066012	64	10	1,82



Per SIAS - RAMO

ART. 2678

Sfera in gomma nera anticalcareo. Diam. est. mm. 62,5 H mm. 47 Ø superiore mm. 50 Ø passante inf. mm. 19.

Anti-calcareous black rubber ball with 62,5 outer diameter, mm. 47 height and mm. 50 diameter higher loop and 19 diameter lower loop.

Codice Code	mm esterno	Conf. Pack	€ cad. € each
0066013	62,5	10	0,73

Per SIAS - RAMO/For SIAS - RAMO



Per STIR BLITZ

ART. 2680

Sfera in gomma nera anticalcareo. Diam. est. mm. 58 H mm. 59 Ø passante superiore mm. 15.

Rubber ball with 58 outer diameter, mm. 59 height and mm. 15 diameter higher loop.

Codice Code	mm esterno	Conf. Pack	€ cad. € each
0066006	58	10	1,65

Per STIR BLITZ/For STIR BLITZ

**ART. 2682**

Morsetto in gomma NR nera per curve tecniche.
NR black rubber clamp used for technical curves.

Codice Code	Ø	per canotti fortube Ø	Conf. Pack	€ cad. € each
0065210	32	25-26	50	0,58
0065211	40	30-32-35	50	0,90

**ART. 2684**

Morsetto in gomma NR nera per curve tecniche.
NR black rubber clamp used for technical curves.

Codice Code	Ø	per canotti fortube Ø	Conf. Pack	€ cad. € each
0065232	32	25-26	50	0,33
0065239	40	26	50	0,50
0065240	40	30-32	50	0,47
0065250	50	32-35-40	50	0,70

**ART. 2686**

Sfera in gomma Ø esterno mm. 57 H mm. 60.
Rubber ball with mm. 57 outer diameter and mm. 60 height.

Codice Code	Passante Loop	Conf. Pack	€ cad. € each
0066002	Alto/high mm. 15	10	1,52

**ART. 2688**

Sfera in gomma Ø esterno mm. 55 H mm. 73,5.
Rubber ball with mm. 55 outer diameter and mm. 73,5 height.

Codice Code	Passante Loop	Conf. Pack	€ cad. € each
0066003	Alto/high mm. 14	10	1,63



ART. 2689

Sfera con perni laterali in para Ø est. 57,5 H mm 71.
Rubber ball with mm 57,5 outer diameter and mm 71 height.

Codice Code	Passante Loop	Conf. Pack	€ cad. € each
0066005	Alto/high mm. 13	10	3,95



ART. 2690

Sfera in gomma Ø esterno mm. 58 H mm. 69.
Rubber ball with mm. 58 outer diameter and mm. 69 height.

Codice Code	Passante Loop	Conf. Pack	€ cad. € each
0066001	Alto/high mm. 15	10	1,65



ART. 2692

Asta completa per cassetta incasso Dora tipo nuovo.
New model of Dora inset W.C. cistern shaft.

Codice Code	Lt	mm	Conf. Pack	€ cad. € each
0066112	12	410	10	6,00
0066114	14	455	10	6,00



ART. 2694

Asta completa per cassetta incasso SIM - BRUNT.
SIM - BRUNT inset W.C. cistern shaft.

Codice Code	Lt	mm	Conf. Pack	€ cad. € each
0066116	12	410	10	6,80
0066118	14	465	10	6,80



ART. 2696

Asta completa per cassetta incasso STIR BLITZ.
STIR BLITZ insert WC cistern shaft.

Codice Code	Lt	mm	Conf. Pack	€ cad. € each
0066122	12	410	10	6,80
0066124	14	465	10	6,80



ART. 2698

Asta completa per cassetta esterna TAGO.
Tago outer W.C. cistern shaft.

Codice Code	mm	Conf. Pack	€ cad. € each
0066120	300	10	3,90



ART. 2700

Asta completa per cassetta incasso DORA.
Dora inset W.C. cistern shaft.

Codice Code	Lt	mm	Conf. Pack	€ cad. € each
0066110	12	410	10	6,40
0066111	14	445	10	6,40



ART. 2702

Cono semplice in gomma para naturale trasparente.
Transparent natural para rubber single cone.

Codice Code	Conf. Pack	€ cad. € each
0065601	25	0,95



ART. 2704

Cono doppio in gomma para naturale trasparente.
Transparent natural para rubber double cone.

Codice Code	Conf. Pack	€ cad. € each
0065602	25	2,10



ART. 2706

Mini sfera con nottolino ottone filetto M4 CATIS in gomma nera anticalcare Ø est. mm. 34 H mm. 29.

Anti-calcareous black rubber M4 CATIS thread bass pallet small ball with mm. 34 outer diameter and mm. 29 height.

Per CATIS

Codice Code	Conf. Pack	€ cad. € each
0202055	10	1,05



ART. 2708

Senza nottolino.
Without bass pallet.

Codice Code	Conf. Pack	€ cad. € each
0202060	10	0,83



ART. 2710

Guarnizione a scodellino per galleggiante in gomma NR nera 50 SH A anticalcare resistente al cloro.

Ball cock chlorine-resistant NR black 50 SH A anti-calcareous rubber cup ring.

Codice Code	Ø	Conf. Pack	€ x 100 pz
0075717	Ø mm. 17	100	8,50
0075719	Ø mm. 19	100	5,80
0075721	Ø mm. 21	100	9,00
0075723	Ø mm. 23	100	14,00
0075724	Ø mm. 24	100	11,50
0075729	Ø mm. 29	100	19,00



ART. 2712

Guarnizione conica in gomma NBR.
NR black rubber conic ring.

Codice Code	Ø	Conf. Pack	€ x 100 pz
0076010	10	100	3,50
0076012	12	100	5,60
0076014	14	100	5,70
0076024	24-26	100	9,30
0076030	30	100	13,60
0076032	32	100	15,50
0076040	40	100	20,50
0076050	50	100	27,50

**ART. 2714**

Guarnizione di tenuta fondo cassetta in gomma NR nera anticalcare resistente al cloro Diam. est. m/m 67,5x34 H 11.
Chlorine-resistant NR black anticalcareous rubber black flush tank gaskets with mm. 67,5x34 outer diameter and 11 height.

Codice Code	Conf. Pack	€ cad. € each
0061680	10	0,68

**ART. 2716**

Guarnizione di tenuta fondo cassetta in gomma NR nera anticalcare resistente al cloro H m/m 9.
Chlorine-resistant NR black anti-calcareous rubber black flush tank gaskets with mm 9 height.

Codice Code	Ø x mm	Conf. Pack	€ cad. € each
0061686	51x26	10	1,15
0061685	53x34	10	1,15

**ART. 2720**

Guarnizione di tenuta fondo cassetta in gomma NR nera anticalcare resistente al cloro Ø est. mm. 60 Ø 44 H 10,5.
Chlorine-resistant NR black anti-calcareous rubber black flush tank gaskets with mm. 60 outer diameter, mm 44 diameter and 10,5 mm height.

Codice Code	Conf. Pack	€ cad. € each
0180514	10	1,05

**ART. 2722**

Piattello con nottolino per batteria Siphonic.
Small plate provided with pallet used for Siphonic battery.

Codice Code	Ø esterno	Conf. Pack	€ cad. € each
0061683	mm. 70	10	1,70

**ART. 2724**

Morsetto sottovaso in gomma nera.
NR black rubber under-bowl clamp.

Codice Code	Ø	Conf. Pack	€ cad. € each
0065136	90-110-120	10	2,20
0065137	90-105-110	10	1,25

**ART. 2726**

Prolunga scarico WC in gomma bianca.
Soft rubber WC straight coupling.

Codice Code	Conf. Pack	€ cad. € each	
0067002	Bianco/White	10	2,10

**ART. 2728**

Prolunga eccentrica scarico WC in gomma bianca.
Soft rubber WC eccentric coupling.

Codice Code	Conf. Pack	€ cad. € each	
0067001	Bianco/White	10	2,15

**ART. 2730**

Manicotto concentrico più eccentrico (brevettato) in gomma termoplastica.
More eccentric concentric sleeve.

Codice Code	Conf. Pack	€ cad. € each	
0067020	Nero/Black	10	7,80

**ART. 2732**

Manicotto diritto per WC in gomma morbida nera.
Soft rubber WC straight black coupling.

Codice Code	mm	Conf. Pack	€ cad. € each
0067004	100/110	10	3,85

**ART. 2734**

Manicotto eccentrico per WC in gomma morbida nera.
Soft rubber WC eccentric black coupling.

Codice Code	mm	Conf. Pack	€ cad. € each
0067008	110	10	6,50

**ART. 2736**

Tubo flessibile in materiale plastico per WC comprimibile Ø raccordo WC da 90 mm a 110 mm.
WC compressible plastic material flexible pipe.

Codice Code	mm	Conf. Pack	€ cad. € each
0067015	230-570	10	9,00

**ART. 2738**

KIT PER CASSETTA PUCCI
Confezione composta da 4 pezzi: cappello - membrana - fondo e n° 2 fibra.
Packaging includes a cap, a membrane, its bottom and 2 fibres.

Codice Code	Conf. Pack	€ cad. € each
0180585	10	2,30



ART. 2750

Canapa pettinata a coda di cavallo ballette da kg. 12,5x4 = kg. 50.

Pony tailed hemp is available in kg. 12,5 small bales.

Codice Code	Conf. Pack	€ al kg € per kg
0021000	50 Kg	8,80



ART. 2752

Canapa pettinata a coda di cavallo in buste da kg. 1.

Heat shrinking pony tailed hemp in kg.1 bags.

Codice Code	Conf. Pack	€ cad. € each
0022000	10	11,20



ART. 2754

Canapa in gomitoli da gr. 100 circa.

Spool hemp gr. 100.

Codice Code	Conf. Pack	€ cad. € each
0021001	80	3,50



ART. 2756

Canapa in bustina gr 100 e gr 250.

Hemp is contained in little bags.

Codice Code	gr	Conf. Pack	€ cad. € each
0020002	100	100	2,00
0020005	250	40	3,90



ART. 2758

Spoletta di canapa.

Hemp bobbin.

Codice Code	gr	Conf. Pack	€ cad. € each
0020050	80	10	5,00



ART. 2760

Contenitore per spoletta.

Hemp bobbin container.

Codice Code	Conf. Pack	€ cad. € each
0020051	10	8,60



ART. 2762

Nastro p.t.f.e per idraulica spessore 0.075.

P.t.f.e tape for hydraulic use which is 0.075 thick.

Codice Code	mt x mm	Conf. Pack	€ cad. € each
0041008	12x12	250	0,32
0041009	25x19	250	1,30
0041010	50x19	25	2,00

Per nastro PTFE 12x1/2
Personalizzato minimo d'ordine.
6000 pezzi + 80%.



ART. 2764

Nastro p.t.f.e per gas spessore 0.10.

0-10 Thick Teflon tape for gas.

Codice Code	mt x mm	Conf. Pack	€ cad. € each
0041058	12x12	250	0,38
0041059	12x19	250	0,58
0041070	12x12 UNI 751/3 FRP	10	1,18
0041072	12x12 UNI 751/3 GRP	10	2,13



ART. 2766

Nastro p.t.f.e professionale spessore 0.20.

0.20 thick Teflon tape for professional use.

Codice Code	mt x mm	Conf. Pack	€ cad. € each
0041098	15x12	25	1,15
0041099	15x19	25	1,73
0041095	15x25	25	2,40



ART. 2768

Nastro p.t.f. e spess. 0,10 mm HD

ROSA indicato per pressioni elevate (es. impianto a vapore, olio diatermico, ecc.)

Codice Code	Rotolo	Conf. Pack	€ cad. € each
0041062	12x12 rosa	10	1,32
0041064	12x19 rosa	10	2,20



ART. 2770

SILICON SEALING TAPE, nastro sigillante per raccordi idraulici. Riposizionabile, compatibile con tutti i metalli plastici, conforme normative gas e acqua. Sostituisce paste, canapa, nastri P.T.F.E. Conforme UNI EN 751/2 C1. A/Arp, certificato AGA.

Repositionable silicon sealing tape.

Codice Code	Rotolo	Conf. Pack	€ cad. € each
0041044	H14mmx5m	90	4,10
0041045	H14mmx15m	60	7,80
0041046	H19mmx15m	48	9,30



ART. 2772

Sigillante anaerobico per filetti acqua-gas-aria-GPL a norma EN 751-1.

Anaerobic sealing product used for water, gas, air and LPG threads according to EN 751-1 regulation.

Codice Code	Tubetti ml Tube ml	Conf. Pack	€ cad. € each
0043005	75	8	7,90
0043000	100	10	9,40
0043025	250	5	13,90

**ART. 2774**

Stagnosald per saldare stagno, rame, piombo, in barattoli.

Canned Stagnosald product used for tin, copper and lead welding.

Codice Code	gr	Conf. Pack	€ cad. € each
0141601	75	20	1,65

**ART. 2776**

Stearol stearina per saldare stagno, piombo, rame, ecc. Stecche gr. 100.

Stearol stearin used to weld tin, lead and copper materials which is available in gr. 100 sticks.

Codice Code	pacchi da parcel weight	Conf. Pack	€ al kg € per kg
0121800	1 Kg	10	10,20

**ART. 2778**

Rotolo filo saldante argento 3,5% spess. mm 2.
3,5% steel welding wire roll thickness mm 2.

Codice Code	gr	Conf. Pack	€ cad. € each
0141301	250	10	44,00

**ART. 2780**

Rotolo filo saldante argento 5% spess. mm 2.
5% steel welding wire roll thickness mm 2.

Codice Code	gr	Conf. Pack	€ cad. € each
0141325	250	10	60,00

**ART. 2782**

Rotolo filo saldante argento 5% spess. mm 3.
5% steel welding wire roll thickness mm 3.

Codice Code	gr	Conf. Pack	€ cad. € each
0141355	250	10	58,00

**ART. 2784**

Legha saldante in verghe ROTHENBERGER S2.
S2 ROTHENBERGER welding alloy bars.

Codice Code	Tipo Type	Conf. Pack	€ al kg € per kg
0141400	S.2	10	70,00

**ART. 2786**

Legha saldante in verghe ROTHENBERGER S5.
S5 ROTHENBERGER welding alloy bars.

Codice Code	Tipo Type	Conf. Pack	€ al kg € per kg
0141402	S.5	5	81,00

**ART. 2788**

Stagno a saldare in verghe.
Welding tin bars.

Codice Code	al at	Conf. Pack	€ al kg € per kg
0141033	33%	10	28,00
0141050	50%	10	38,00

**ART. 2790**

Decapante in GEL per saldatura rame, stagno, in tubetti con pennello gr. 100.

Pickling GEL used for copper and tin welding is contained in tubes provided with a brush.

Codice Code		Conf. Pack	€ cad. € each
0141501	Caleffi	10	14,00
0141500	Similare	10	8,60

**ART. 2794**

Cannello saldatore accensione piezo in ABS.

Professional cartridge blowtorch.

Codice Code		Conf. Pack	€ cad. € each
7020858		1	29,00

**ART. 2796**

Cartuccia universale a perforazione gr 190 con valvolina interna top safe system.

Standard gas cartridge gr 190 top safe system.

Codice Code	gr.	Conf. Pack	€ cad. € each
7020861	190	10	3,30

**ART. 2798**

Cannello Saldatore Super fire 3.
Super fire 3 welding torch.

Codice Code		Conf. Pack	€ cad. € each
7020910	con bombola	1	300,00

**ART. 2800**

Bombola Map Gas Super fire 3.
Map gas Super fire 3 cylinder.

Codice Code		Conf. Pack	€ cad. € each
7020909	ml. 750	12	38,00

**ART. 2801**

Cannello saldatore Super fire 2.

Codice Code		Conf. Pack	€ cad. € each
7020912		1	257,00

**ART. 2802**

Bombola Map Gas per Super fire 2.
Map gas Super fire 2 cylinder.

Codice Code		Conf. Pack	€ cad. € each
7020904	750 ml	12	39,20



ART. 2804

LOCTITE 55 il filo sigillaraccordi. Sigillante multifibra in nylon per filettature sia in plastica che metallo.

Codice Code	mt	Conf. Pack	€ cad. € each
1064020	150	48	23,00
1064022	50 Blister	24	16,00



ART. 2806

Tangit UNI-LOCK filo sigillante periscoperto pronto all'uso. *Tangit UNI-LOCK sealing products ready to be used.*

Codice Code	mt	Conf. Pack	€ cad. € each
1064011	80	20	16,30
1064014	160	20	24,80



ART. 2808

TANGIT, adesivo a solvente per PVC rigido, in tubetti. *TANGIT solvent glue used for rigid PVC materials which is contained in small tubes.*

Codice Code	gr	Conf. Pack	€ cad. € each
1064002	125	12	11,00



ART. 2810

TANGIT, adesivo a solvente per PVC rigido, in barattoli. *TANGIT solvent glue used for rigid PVC materials which is contained in cans.*

Codice Code	gr	Conf. Pack	€ cad. € each
1064004	250	24	17,90
1064006	500	12	31,00
1064007	1000	12	54,00



ART. 2812

TANGIT REINIGER detergente in barattolo. *TANGIT REINIGER it is necessary to integrate it with canned TANGIT glue.*

Codice Code	ml	Conf. Pack	€ cad. € each
1064010	1.000	12	35,00



ART. 2814

TANGIT detergente speciale KS lt. 1. *TANGIT KS lt.1.*

Codice Code	Conf. Pack	€ cad. € each
1064012	8	23,00



ART. 2826

Silicon per giunti a vite in barattoli. *Canned Silicon product used for screw couplings.*

Codice Code	gr	Conf. Pack	€ cad. € each
0121200	460	48	4,15



ART. 2828

Silic per giunti a vite in barattoli. *Canned Silic product used for screw couplings.*

Codice Code	gr	Conf. Pack	€ cad. € each
0121201	460	60	3,65



ART. 2830

Pasta verde per giunti a vite in barattoli da gr. 450. *Sealing compound for threaded joints and fittings in can of 450 gr.*

Codice Code	gr	Conf. Pack	€ cad. € each
0121100	450	48	2,10



ART. 2832

Pasta verde per giunti a vite in tubetto da gr 100. *Sealing compound for threaded joints and fittings in tube of mets.*

Codice Code	gr	Conf. Pack	€ cad. € each
0121175	100	12	1,60



ART. 2834

Ermetica Pasta verde per giunti a vite in barattoli da gr. 460. *Ermetic Green compound used for screw couplings which is contained in gr. 460 cans.*

Codice Code	gr	Conf. Pack	€ cad. € each
0121105	460	60	2,80



ART. 2836

Pasta extra gas priva di sostanze nocive per gas-acqua. *Gas and water extra gas compound without noxious substances.*

Codice Code	gr	Conf. Pack	€ cad. € each
0121101	460	60	3,90

**ART. 2838**

Pasta Kolmat per acqua e gas priva di sostanze nocive in barattoli.
Canned gas and water Kolmat compound without noxious substances.

Codice Code	gr	Conf. Pack	€ cad. € each
0121300	450	15	9,80

**ART. 2840**

Pasta Kolden per gas acqua in barattoli da ml 400.
Gas and water Kolden compound which is contained in ml. 400 cans.

Codice Code	ml	Conf. Pack	€ cad. € each
0121350	400	30	6,00

**ART. 2842**

Stucco caldaia in barattoli.
Canned boiler plaster.

Codice Code	gr	Conf. Pack	€ cad. € each
0121400	900	27	3,70

**ART. 2844**

Stucco per sanitari in barattoli.
Canned sanitary facility plaster.

Codice Code	gr	Conf. Pack	€ cad. € each
0121510	900	24	3,70

**ART. 2846**

Sigillante per sanitari e piani cottura in strisce da cm 50 su 4 file = 2mt.
White Elastuc mastic is available in small bars.

Codice Code	gr	Conf. Pack	€ cad. € each
0121715	400	30	5,90

Idem grigio in rotoli da mt 25 su 5 file = 125mt.
White Elastuc mastic is available in small bars.

Codice Code	mt	Conf. Pack	€ cad. € each
0121716	25	2	185,00

**ART. 2848**

Scioglo in polvere per sgrassare e pulire, disincrostante.
Scioglo powder used to degrease and clean sanitary facilities.

Codice Code	gr	Conf. Pack	€ cad. € each
0121705	600	36	6,00

**ART. 2849**

DRIP-STOP Mastiche epossidico bicomponente. È un prodotto facile nella preparazione e nell'uso. Permette di arrestare le perdite di tubazioni senza svuotare e smontare l'impianto. Polimerizza a temperatura ambiente e anche immerso in acqua. Verniciabile, ideale per tutti i tipi di riparazioni su metalli, vetro, plastica, legno.

Codice Code	gr	Conf. Pack	€ cad. € each
7020580	65	10	8,00

**ART. 2851**

LOCTITE WRAP Super nastro isolante e sigillante multiuso. È un innovativo nastro senza adesivo che una volta avvolto intorno ad una superficie fonde su se stesso, sigilla e protegge istantaneamente l'area da perdite d'aria e d'acqua, corrosione e urti. Sviluppa la sua massima resistenza dopo 24 ore. Temp. - 54 °C ÷ 260 °C.

Codice Code		Conf. Pack	€ cad. € each
1064025	2,5 cm x 4,27 m	10	26,00

**ART. 2853**

TERMOSINT Additivo fluidificante liquido per massetto. Ideale per ottimizzare e valorizzare le proprietà fisiche del massetto di copertura degli impianti a pavimento radiante; rende il calcestruzzo fluido ed evita la formazione di sacche d'aria. Dosaggio: 1 Lt x 100Kg di cemento.

Codice Code	Lt	Conf. Pack	€ cad. € each
0101406	10	1	37,00

**ART. 2857**

Antigelo liquido per impianti riscaldamento. Percentuale x Lt. 100 d'acqua -5: 10%, -20: 35%, -10: 20%, -30: 35%.
Liquid Anti-Freeze product used for heating systems having the following percentages per 100 water lt.: -5: 10%, -20: 35%, -10: 20%, -30: 35%.

Codice Code	lattine kg. can content	Conf. Pack	€ cad. € each
0900512	Kg. 12	1	56,00
0900525	Kg. 25	1	115,00

**ART. 2859**

DISICAL - Disincrostante acido inibito a viraggio di colorazione, specifico per la rimozione di residui e incrostazioni calcaree e ferrose da caldaie, tubazioni, serpentine, pompe, ecc.

Codice Code	lt	Conf. Pack	€ cad. € each
6022001	1	10	4,00
6022005	5	2	15,00
6022010	10	1	27,60
6022025	25	1	64,00

**ART. 2860**

Olio per filettare.
Oil to thread.

Codice Code		Conf. Pack	€ cad. € each
7023950	ml 400	24	10,00
7023952	lt 5	6	57,00



ART. 2861

Silicone acetico antimuffa in cartucce da ml. 280 SIL 3004.

Anti-mould silicone is contained in ml. 280 cartridges SIL 3004.

Codice Code		Conf. Pack	€ cad. € each
0121902	Trasparente	30	3,40
0121901	Bianco/White	30	3,45



ART. 2863

Silicone acetico antimuffa professionale in cartucce da ml. 280.

Professional anti-mould silicone is contained in ml. 280 cartridges.

Codice Code		Conf. Pack	€ cad. € each
0121915	Trasparente	30	8,55
0121916	Bianco/White	30	8,60



ART. 2873

Pistola per silicone modello a frizione inglese.

English clutch silicone gun.

Codice Code		Conf. Pack	€ cad. € each
0122001		10	3,60



ART. 2874

Pistola per silicone modello a stelo originale inglese semiprofessionale.

Semi-professionale English original shaft silicone gun.

Codice Code		Conf. Pack	€ cad. € each
0122000		10	4,60



ART. 2875

Pistola per silicone modello a tubo in alluminio professionale.

Professional aluminium tube silicone gun.

Codice Code		Conf. Pack	€ cad. € each
0122002		2	19,50



ART. 2864

Sigillante invisibile per docce.

Crystal clear.

Codice Code	ml	Conf. Pack	€ cad. € each
0121801	310	12	21,00



ART. 2865

Silicone rosso per alte temperature in cartucce da ml. 310.

Red silicone for high temperature is contained in ml. 310 cartridges.

Codice Code	Colore Colour	Conf. Pack	€ cad. € each
0121920	Rosso/Red	15	16,00



ART. 2876

Zinco spray a freddo adatto a tutti i metalli in bombolette.

Cold zinc spray contained in cans which is suitable for all metals.

Codice Code	ml	Conf. Pack	€ cad. € each
0121930	400	24	6,70



ART. 2877

Svita tutto spray in bombolette.

Unscrews spray which is contained in cans.

Codice Code	ml	Conf. Pack	€ cad. € each
0121935	400	24	5,60



ART. 2869

Tassello chimico Forte Presa.

Chemical anchors strong grip.

Codice Code	ml	Conf. Pack	€ cad. € each
0121965	300	15	18,80



ART. 2878

Bomboletta spray per pulizia caldaie.

Boiler cleaning spray bottle.

Codice Code	ml	Conf. Pack	€ cad. € each
2385005	400	10	9,80



ART. 2872

Schiuma poliuretana in flaconi.

Polyurethane foam is contained small bottles.

Codice Code	ml	Conf. Pack	€ cad. € each
0121950	750	12	11,00



ART. 2879

Scivolante lubrificante fluido spray per il montaggio di tubi e raccordi PVC e PP.

Sliding lubricant fluid suitable for PVC e PP pipes and fittings.

Codice Code	ml	Conf. Pack	€ cad. € each
1064029	400	24	7,00



**ART. 2880**

Sgorgosi liquido. Disotturante chimico ad alta concentrazione per scarichi. Sgorgosi libera ogni tipo di intasamento generato da materiali organici. Sgorgosi is an high-concentration drain unclogging chemical product. Sgorgosi avoids any kind of clogging phenomenon which is caused by organic substances.

Codice Code	lt	Conf. Pack	€ cad. € each
6022050	1	6	5,45

**ART. 2881**

CS cleaner trattamento disincrostante per cassette di risciacquo wc. Liquido per la rimozione rapida di incrostazioni calcaree ed ossidi nelle cassette wc.

Codice Code	lt	Conf. Pack	€ cad. € each
6022058	1	12	6,30

**ART. 2884**

Molla sgombratubi con spirale in acciaio. Steel coil tube remover spring.

Codice Code	cm	Conf. Pack	€ cad. € each
7205825	250	1	3,70
7205835	350	1	4,70
7205850	500	1	6,30

**ART. 2886**

Pistola sturatubo a pressione. Drain cleaner gun pressure.

Codice Code	Conf. Pack	€ cad. € each
7205602	2	30,00

**ART. 2888**

Pompa sturalavandini con ventosa. Pluger pump with sucker.

Codice Code	Conf. Pack	€ cad. € each
7205601	10	6,50

**ART. 2890**

Tampone in gomma con manico in legno. Rubber pad with wooden handle.

Codice Code	Ø	Conf. Pack	€ cad. € each
7205412	120	10	3,90
7205415	150	10	5,70

**ART. 2892**

Nastro segnaletico tubo acqua. Rotoli mt. 200 x cm. 10.

Water warning tape is available in mt. 200 x cm. 10 rolls.

Codice Code	x tubo	Conf. Pack	€ cad. € each
0106260	acqua	10	8,00

**ART. 2893**

Nastro segnaletico tubo gas. Rotolo mt 200 x 10 cm.

Gas tube warning tape is available in mt 200 x cm 10 rolls.

Codice Code	x tubo	Conf. Rot	€ cad. € each
0106210	gas	10	8,00



Estensibile

ART. 2897

Guaina flessibile per tubazioni gas in polipropilene autoestinguente secondo UNI-CIG 7129. Di facile utilizzo l'operazione di copertura dei tubi in rame avviene quando la guaina è ancora compattata, cioè a 1/3 della metratura, facilitata dall'interno liscio e solo dopo la guaina viene estesa su tutta la lunghezza del tubo.

Flexible protection sheath used to insert underground tubes.

Codice Code	Ø mm	Conf. Rot	€ al mt € per mt
3042420	20	mt 50	0,99
3042425	25	mt 50	1,30
3042430	30	mt 50	1,86
3042440	40	mt 50	2,45

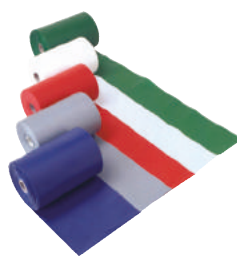
**ART. 2900**

Benda plastica satinata in rotoli da mt. 25 - alt. cm. 10 - peso gr. 350 ca.

Codice Code	Colore Colour	Conf. Pack	€ cad. € each
0104001	Bianca/White	60	4,30
0104002	Rossa/Red	60	4,30
0104003	Blu/Blue	60	4,30

**ART. 2902**

Rotolo lana di roccia cm 500x100. Rockwool roll

Codice Code	Conf. Pack	€ al mq
3156330	1 rotolo mq 5	25,00

**ART. 2903**

Pannello isolante per retroradiatori. Back radiator insulating panel.

Codice Code	cm	Conf. Pack	€ cad. € each
0106100	70x100	10	8,00

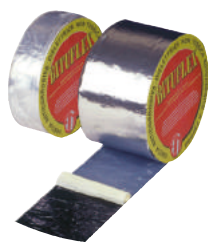

ART. 2912

Bituflex con film in alluminio rinforzato adatta ad impermeabilizzare, sigillare, riparare.
Bituflex with strength femed alluminium film, suited to impermeabilize, seal, repair.

Codice Code	H cm x mt	Conf. Pack	€ cad. € each
0105050	5x10	12	31,00
0105060	10x10	6	57,00



ART. 2914

Bende in garza amidata.
Starched gauze bands.

Codice Code	cm x mt	Conf. Pack	€ cad. € each
0105300	10x10	200	8,00



ART. 2920

Nastro alluminio adesivo per fasciature tubazioni.
Adhesive aluminium tape used to band insulating materials.

Codice Code	cm x mt	Conf. Pack	€ cad. € each
0105106	5 - 50	24	12,60
0105107	7,5 - 50	16	18,80



ART. 2930

Benda autoamalgamante biadesiva. Ottima per isolare cavi elettrici o condotte acciaio da interrare.
Bio-adhesive auto-amalgamating tape mt. 10.

Codice Code	H cm x mt	Conf. Pack	€ cad. € each
0105070	5x10	30	22,00
0105080	10x10	15	40,00



ART. 2932

Nastro gomma adesivo, anticondensa alto cm. 5 x mt. 10 spessore mm. 3.
Cm. 5 x mt. 10 high rubber tape.

Codice Code	Conf. Pack	€ cad. € each	
0101501	nero	50	5,80



ART. 2934

Nastro isolante anticondensa colore ice ghiaccio per la finitura degli impianti di condizionamento e riscaldamento Temperatura di impiego da -80 a +100° C.

Codice Code	cm x mt	Conf. Pack	€ cad. € each
0101770	5x10	24	7,60



ART. 2936

Fascia anticondensa per tubazioni calde e fredde -29 +70 °C / Rotoli mt 9 x H cm 5.
Hot and cold tube anti-condenser water band at -29 +70 °C which is available in cm 5 x mt. 9 rolls.

Codice Code	spessore thickness	Conf. Pack	€ cad. € each
0101505	3 mm	12	19,00



ART. 2942

Benda bituminosa adatta per la protezione di tubazioni. Temperatura di applicazione: da 5 a +35 °C. Temperatura di esercizio da -20 a +104 °C.
Bituminous band which is used for pipe protection. Application temperature ranges from 5 to +35 °C. Working temperature ranges from -20 to +104°C.

Codice Code	cm x ml	Conf. Pack	€ cad. € each
0105005	5x10	12	19,00
0105007	7,5x10	8	26,60
0105010	10x10	6	34,00



ART. 2944

Nastro adesivo dielettrico nero.
Black dielectric adhesive tape.

Codice Code	cm x mt	Conf. Pack	€ cad. € each
0101701	5x20	96	4,10
0101702	10x20	48	8,00
Colore grigio perla.			
0101750	5x25	48	4,80



ART. 2945

Nastro adesivo in cotone e polietilene colore argento.
Adhesive tape rolls.

Codice Code	cm x mt	Conf. Pack	€ cad. € each
0101510	5x50	24	12,50



ART. 2948

Benda dielettrica isolante anticorrosiva per la protezione di tubature interrate e non.
Anti-corrosive paraffinic band which is used to protect underground pipes and not.

Codice Code	cm x mt	Conf. Pack	€ cad. € each
0105000	10x10	18	12,50



ART. 2950

Fibra di vetro, rotolo alto cm. 20 x ml. 200.
Cm. 20 x ml. 200 high glass fibre roll.

Codice Code	Rotoli Rolls	Conf. Pack	€ al Kg € per Kg
0120600	8 kg	5	30,00



ART. 2952

Nastro in fibra di vetro di alta qualità per isolamento condotte, coperture di cavi e isolamento elettrica.
Glass fiber tape for pipe insulation, cable coverings and electrical insulation.

Codice Code	mm	mt	€ al mt € per mt
0081400	60x2	50	1,35

Tubo multistrato in rotoli, adatto per impianti sanitari, riscaldamento tradizionale e riscaldamento a pavimento. Strato interno in Pexb, strato intermedio in alluminio saldato testa / testa, strato esterno in Pexb.

Disponibile anche rivestito con guaina in polietilene espanso a bassa densità, cellule chiuse Classe 1. Autoestingente, antigraffio, colore azzurro Coefficiente conducibilità termica = 0,43 W/mk.

Conforme alla legge 10/91.

Temperatura max d'esercizio 95°C - Pressione massima d'esercizio 10 bar. Conforme alla norma UNI 10954 - Made in Italy.



ART. 3000

Tubo multistrato nudo.
Multilayer pipe.

Codice Code	Ø	Rotolo mt	€ al mt € per mt
1070514	14x2	100	1,33
1070516	16x2	100	1,24
1070518	18x2	100	1,68
1070520	20x2	100	1,68
1070526	26x3	50	3,32
1070532	32x3	50	5,26



ART. 3002

Tubo multistrato rivestito colore blu.
Covered multilayer pipe.

Codice Code	Ø	Conf. Pack	Rotolo mt	€ al mt € per mt
1070616	16 x 2	6	50	1,70
1070618	18 x 2	6	50	2,48
1070620	20 x 2	10	50	2,30
1070626	26 x 3	10	25	4,25
1070632	32 x 3	10	25	8,00



ART. 3003

Tubo multistrato PE-X/AL/PE-X per gas in
GUAINA CORRUGATA
Gas Multilayer pipe with protection sheath

Codice Code	Ø	Rotolo mt	€ al mt € per mt
1082116	16x2	50	2,70
1082120	20x2	50	3,78
1082126	26x3	50	8,00

Tubo multistrato per gas per adduzione di gas combustibile secondo normativa UNI/TS 11344 " Sistemi di tubazioni multistrato metalloplastici e raccordi per il trasporto di combustibili gassosi per impianti interni"

La normativa UNI/TS 11344 stabilisce anche le condizioni di utilizzo del sistema: trasporto di combustibili gassosi alimentati da reti di distribuzione del gas con pressione massima di esercizio di 0.5 bar e temperatura di esercizio da -20°C a +70°C.



Raccordi in ottone a pressare per gas profilo TH-H-U



ART. 3004

Raccordo diritto maschio.
Male straight fitting.

Codice Code	Ø	Conf. Pack	€ cad. € each
1095215	1/2"x16	10	4,15
1095217	1/2"x20	10	4,85
1095222	3/4"x20	10	7,50
1095223	3/4"x26	5	6,80



ART. 3007

Raccordo a Tee.
Tee fitting.

Codice Code	Ø	Conf. Pack	€ cad. € each
1095516	16x16x16	10	8,50
1095520	20x20x20	10	11,15
1095526	26x26x26	5	17,90



ART. 3005

Raccordo diritto femmina.
Female straight fitting.

Codice Code	Ø	Conf. Pack	€ cad. € each
1095315	1/2"x16	10	4,35
1095317	1/2"x20	10	5,00
1095322	3/4"x20	10	7,00
1095323	3/4"x26	5	7,60



ART. 3008

Tee a 90° ridotto.
Reduced tee.

Codice Code	Ø	Conf. Pack	€ cad. € each
1095618	20x20x16	10	10,80
1095621	20x26x20	5	13,40



ART. 3009

Gomito a 90° con derivazione femmina.
Female elbow fitting.

Codice Code	Ø	Conf. Pack	€ cad. € each
1095715	1/2"x16	10	5,40
1095717	1/2"x20	10	6,45
1095722	3/4"x20	10	7,70
1095723	3/4"x26	5	11,65



ART. 3006

Manicotto.
Socket.

Codice Code	Ø	Conf. Pack	€ cad. € each
1095416	16x16	10	5,20
1095420	20x20	10	7,35
1095426	26x26	5	9,20



ART. 3010

Raccordo diritto con dado girevole e O-Ring. Sede conica.

Codice Code	Ø	Conf. Pack	€ cad. € each
1095820	16x3/4"	10	6,05
1095822	20x3/4"	10	6,20

**ART. 3022**

Raccordo diritto maschio.
Male straight fitting.

Codice Code	Ø	Conf. Pack	€ cad. € each
1097015	1/2"x16	10	2,00
1097016	1/2"x18	10	3,77
1097017	1/2"x20	10	3,35
1097020	3/4"x16	10	3,00
1097021	3/4"x18	5	3,90
1097022	3/4"x20	5	3,52
1097023	3/4"x26	5	6,00
1097026	1"x26	5	6,30
1097032	1"x32	5	9,80

**ART. 3032**

Raccordo Tee maschio.
Male Tee fitting.

Codice Code	Ø	Conf. Pack	€ cad. € each
1097515	16x1/2"x16	10	4,70
1097516	18x1/2"x18	10	7,20
1097517	20x1/2"x20	10	7,20
1097522	20x3/4"x20	5	8,00
1097523	26x3/4"x26	5	12,50
1097526	26x1"x26	5	14,50
1097532	32x1"x32	5	23,00

**ART. 3024**

Raccordo diritto femmina.
Female straight fitting.

Codice Code	Ø	Conf. Pack	€ cad. € each
1097115	1/2"x16	10	2,22
1097116	1/2"x18	10	4,10
1097117	1/2"x20	10	3,32
1097120	3/4"x16	5	3,50
1097121	3/4"x18	5	4,20
1097122	3/4"x20	5	3,85
1097123	3/4"x26	5	5,85
1097126	1"x26	5	6,40
1097132	1"x32	5	9,65

**ART. 3034**

Raccordo gomito femmina.
Female elbow fitting.

Codice Code	Ø	Conf. Pack	€ cad. € each
1097615	1/2"x16	10	3,20
1097616	1/2"x18	10	4,70
1097617	1/2"x20	10	4,28
1097622	3/4"x20	10	5,15
1097623	3/4"x26	5	7,00
1097626	1"x26	5	8,20
1097632	1"x32	5	12,20

**ART. 3026**

Raccordo diritto intermedio.
Double straight fitting.

Codice Code	Ø	Conf. Pack	€ cad. € each
1097216	16x16	10	3,50
1097218	18x18	10	5,20
1097220	20x20	10	6,00
1097226	26x26	5	9,00
1097232	32x32	5	16,50

**ART. 3036**

Raccordo gomito.
Elbow fitting.

Codice Code	Ø	Conf. Pack	€ cad. € each
1097716	16x16	10	4,05
1097718	18x18	10	6,35
1097720	20x20	10	6,30
1097726	26x26	5	10,00
1097732	32x32	5	18,00

**ART. 3028**

Raccordo a tee.
Tee fitting.

Codice Code	Ø	Conf. Pack	€ cad. € each
1097316	16x16x16	10	5,60
1097318	18x18x18	5	9,70
1097320	20x20x20	5	9,25
1097326	26x26x26	5	15,40
1097332	32x32x32	5	26,00

**ART. 3038**

Raccordo gomito maschio.
Male elbow fitting.

Codice Code	Ø	Conf. Pack	€ cad. € each
1097815	1/2"x16	10	2,94
1097816	1/2"x18	10	4,65
1097817	1/2"x20	10	4,22
1097822	3/4"x20	10	4,50
1097823	3/4"x26	5	7,30
1097826	1"x26	5	7,90
1097832	1"x32	5	12,50

**ART. 3030**

Raccordo a tee femmina.
Female Tee fitting.

Codice Code	Ø	Conf. Pack	€ cad. € each
1097415	16x1/2"x16	10	4,80
1097416	18x1/2"x18	10	6,90
1097417	20x1/2"x20	10	7,40
1097422	20x3/4"x20	5	8,20
1097423	26x3/4"x26	5	12,50
1097426	26x1"x26	5	18,00
1097432	32x1"x32	5	22,00

**ART. 3040**

Raccordo gomito femmina c/staffa.
Female Wallplate elbow.

Codice Code	Ø	Conf. Pack	€ cad. € each
1097915	1/2"x16	10	4,00
1097916	1/2"x18	10	6,45
1097917	1/2"x20	10	6,00

**ART. 3050**

Raccordo diritto maschio.
Male straight fitting.

Codice Code	Ø	Conf. Pack	€ cad. € each
1098015	1/2"x16	10	2,10
1098017	1/2"x20	10	2,70
1098022	3/4"x20	10	3,40
1098023	3/4"x26	5	4,40
1098032	1"x32	5	6,50

**ART. 3052**

Raccordo diritto femmina.
Female straight fitting.

Codice Code	Ø	Conf. Pack	€ cad. € each
1098115	1/2"x16	10	2,48
1098117	1/2"x20	10	3,15
1098122	3/4"x20	10	4,00
1098123	3/4"x26	5	4,95
1098132	1"x32	5	7,70

**ART. 3054**

Raccordo diritto.
Double fitting.

Codice Code	Ø	Conf. Pack	€ cad. € each
1098216	16x16	10	3,05
1098220	20x20	10	3,50
1098226	26x26	5	6,00
1098232	32x32	5	8,80

**ART. 3056**

Raccordo a Tee.
Tee fitting.

Codice Code	Ø	Conf. Pack	€ cad. € each
1098316	16x16x16	10	4,80
1098320	20x20x20	5	6,80
1098326	26x26x26	5	12,50
1098332	32x32x32	5	18,40
1098350	20x16x16	5	7,00
1098352	20x16x20	5	6,80
1098354	20x20x16	5	7,30
1098356	20x26x20	5	13,20
1098360	26x16x26	5	13,30
1098362	26x20x16	5	13,30
1098364	26x20x20	5	13,50

**ART. 3058**

Raccordo Tee F.
Female tee fitting.

Codice Code	Ø	Conf. Pack	€ cad. € each
1098415	16x1/2"x16	5	4,70
1098417	20x1/2"x20	5	6,20
1098422	20x3/4"x20	5	7,70
1098423	26x3/4"x26	5	10,50
1098432	32x1"x32	5	15,60

**ART. 3060**

Raccordo Tee M.
Male tee fitting.

Codice Code	Ø	Conf. Pack	€ cad. € each
1098915	16x1/2"x16	5	5,10
1098917	20x1/2"x20	5	6,30
1098922	20x3/4"x20	5	7,70
1098923	26x3/4"x26	5	10,50

**ART. 3062**

Raccordo a gomito.
Elbow fitting.

Codice Code	Ø	Conf. Pack	€ cad. € each
1098516	16x16	10	3,70
1098520	20x20	5	5,00
1098526	26x26	5	8,30
1098532	32x32	5	11,90

**ART. 3064**

Raccordo a gomito femmina.
Female elbow fitting.

Codice Code	Ø	Conf. Pack	€ cad. € each
1098615	1/2"x16	10	3,00
1098617	1/2"x20	10	4,00
1098622	3/4"x20	10	4,90
1098623	3/4"x26	5	6,90
1098632	1"x32	5	11,00

**ART. 3066**

Raccordo a gomito maschio.
Male elbow fitting.

Codice Code	Ø	Conf. Pack	€ cad. € each
1098715	1/2"x16	10	3,30
1098717	1/2"x20	10	4,10
1098722	3/4"x20	10	5,40
1098723	3/4"x26	5	6,80
1098732	1"x32	5	10,80

**ART. 3068**

Raccordo a gomito con flangia.
Wallplate elbow fitting.

Codice Code	Ø	Conf. Pack	€ cad. € each
1098815	1/2"x16	5	4,50
1098817	1/2"x20	5	5,00

**ART. 3069**

Valvola a sfera ad incasso con cappuccio cromato.
Built in valve with chrome plated lever cup.

Codice Code	Ø	Conf. Pack	€ cad. € each
2243601	16 x 16	5	28,30
2243602	20 x 20	5	36,30



ART. 3133

Collettore semplice componibile, 2 derivazioni, interasse 35 mm nichelato attacco 1/2".
Simple manifold 2 connections.
Distance between connections 35 mm.

Codice Code	Ø	Conf. Pack	€ cad. € each
2235052	3/4"	20	5,50



ART. 3134

Collettore semplice componibile 3 derivazioni nichelato attacco 1/2", interasse 35 mm.
Simple manifold 3 connections.

Codice Code	Ø	Conf. Pack	€ cad. € each
2235053	3/4"	20	8,30



ART. 3135

Collettore semplice componibile 4 derivazioni nichelato attacco 1/2", interasse 35 mm.
Simple manifold 4 connections.

Codice Code	Ø	Conf. Pack	€ cad. € each
2235054	3/4"	20	11,00



ART. 3136

Collettore di distribuzione componibile con valvole di intercettazione, derivazioni maschio. Corpo stampato in ottone nichelato. Temperatura massima d'esercizio 110°C.
Modular distribution manifold with shut-off valves, male outlets.

Codice Code	Ø	Conf. Pack	€ cad. € each
1077702	3/4"x 2 vie	4	15,30
1077703	3/4"x 3 vie	4	22,30
1077705	3/4"x 4 vie	4	29,00

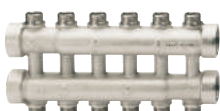

ART. 3137

Collettore complanare con derivazioni maschio, adatti per raccordi per tubo di rame, PEX, polibutilene e multistrato. Corpo fuso in ottone nichelato. Temperatura max esercizio 110°C. Attacchi filettati: ISO228.
Dual distribution manifold male outlets.

Codice Code	Ø 3/4	Conf. Pack	€ cad. € each
1077585	2+2	1	27,50
1077586	4+4	1	46,40
1077587	6+6	1	69,00
1077588	8+8	1	96,50
1077589	10+10	1	130,00



ART. 3138

Cassetta universale in plastica per collettori. Portello di chiusura provvisto di fori di ventilazione. Fornita di una pellicola asportabile per la protezione dei collettori dalle opere di intonacatura.
Universal plastic box for manifolds.

Codice Code	mm	Conf. Pack	€ cad. € each
1077601	350x350x90	1	26,00
1077602	500x350x90	1	33,00
1077603	650x350x90	1	43,00
1077604	800x400x95	1	58,00

La cassetta in plastica con aggiunta kit è adatta all'uso con i collettori di qualunque produttore.



ART. 3139

Kit per collettori complanari composto da: 2 supporti + 2 fascette.
Set to fix dual manifolds to the plastic box consisting of: 2 brackets and 2 plastic strips.

Codice Code	Ø	Conf. Pack	€ cad. € each
1077610		1	3,90



ART. 3140

Kit per collettori semplici composto da: 2 supporti lunghi + 2 supporti corti + 4 fascette.
Set to fix simple manifolds to the plastic box consisting of: 2 long brackets, 2 short brackets, 4 plastic strips.

Codice Code	Ø	Conf. Pack	€ cad. € each
1077612		1	6,00



RE

ART. 3141

Collettore semplice componibile 2 derivazioni nichelato con valvola di regolazione, interasse 36 mm. 3/4" attacco 1/2".

Codice Code	Maniglia	Conf. Pack	€ cad. € each
2235578	verde	60	9,00

Disponibile su richiesta maniglie blu o rosse



RE

ART. 3142

Collettore semplice componibile 3 derivazioni nichelato con valvola di regolazione, interasse 36 mm. 3/4" attacco 1/2".

Codice Code	Maniglia	Conf. Pack	€ cad. € each
2235678	verde	45	13,50

Disponibile su richiesta maniglie blu o rosse



RE

ART. 3143

Collettore semplice componibile 4 derivazioni nichelato con valvola di regolazione, interasse 36 mm. 3/4" attacco 1/2".

Codice Code	Maniglia	Conf. Pack	€ cad. € each
2235778	verde	35	18,00

Disponibile su richiesta maniglie blu o rosse



ART. 3144

Adattatore 1/2" cromato per tubo rame.
Adaptor for copper tube.

Codice Code	Ø	Conf. Pack	€ cad. € each
2235812	12	50	1,45
2235814	14	50	1,45
2235816	16	50	1,45



RE

ART. 3145

Adattatore 1/2" cromato per tubo multistrato.
Adaptor for multilayer pipe.

Codice Code	Ø	Conf. Pack	€ cad. € each
2236014	14x2	50	2,60
2236016	16x2	50	1,60

ART. 3150

Valvola diritta per radiatori, attacco filettato femmina per tubo ferro.
Straight manual valve female thread.

Codice Code	Ø	Conf. Pack	€ cad. € each
2230408	1/2"	12	6,40

ART. 3164

Detentore ad angolo per radiatori attacco filettato maschio per tubo rame.
Angle lockshield, male thread.

Codice Code	Ø	Conf. Pack	€ cad. € each
2231407	3/8"	12	5,10
2231408	1/2"	12	5,50

ART. 3152

Detentore diritto per radiatori, attacco filettato femmina per tubo ferro.
Straight lockshield female thread.

Codice Code	Ø	Conf. Pack	€ cad. € each
2230808	1/2"	12	5,90

ART. 3166

Valvola diritta termostattabile per radiatori, attacco filettato femmina con volantino per tubo ferro.
Straight convertible value with handle, female thread.

Codice Code	Ø	Conf. Pack	€ cad. € each
2232507	3/8"	4	11,50
2232508	1/2"	4	12,20

ART. 3154

Valvola diritta per radiatori, attacco filettato maschio per tubo rame.
Straight manual valve male thread.

Codice Code	Ø	Conf. Pack	€ cad. € each
2231208	1/2"	12	6,50

ART. 3170

Valvola diritta termostattabile per radiatori, attacco filettato maschio con volantino per tubo rame.
Straight convertible valve with handle, male thread.

Codice Code	Ø	Conf. Pack	€ cad. € each
2232707	3/8"	4	11,40
2232708	1/2"	4	12,00

ART. 3156

Detentore diritto per radiatori, attacco filettato maschio per tubo rame.
Straight lockshield male thread.

Codice Code	Ø	Conf. Pack	€ cad. € each
2231608	1/2"	12	6,10

ART. 3174

Valvola ad angolo termostattabile per radiatori, attacco filettato femmina, con volantino per tubo ferro.
Angle convertible valve with handle, female thread.

Codice Code	Ø	Conf. Pack	€ cad. € each
2232907	3/8"	4	11,40
2232908	1/2"	4	12,00

ART. 3158

Valvola ad angolo per radiatori, attacco filettato femmina per tubo ferro.
Angle manual valve, female thread.

Codice Code	Ø	Conf. Pack	€ cad. € each
2230207	3/8"	12	5,70
2230208	1/2"	12	5,90

ART. 3178

Valvola ad angolo termostattabile per radiatori, attacco filettato maschio, con volantino per tubo rame.
Angle convertible value with handle, male thread.

Codice Code	Ø	Conf. Pack	€ cad. € each
2233107	3/8"	4	11,00
2233108	1/2"	4	11,60

ART. 3160

Detentore ad angolo per radiatori, attacco filettato femmina per tubo ferro.
Angle lockshield, female thread.

Codice Code	Ø	Conf. Pack	€ cad. € each
2230607	3/8"	12	5,20
2230608	1/2"	12	5,40

ART. 3182

Comando termostatico con elemento sensibile a olio.
Thermostatic control head with oil-filled element.

Codice Code	Ø	Conf. Pack	€ cad. € each
2233508	1/2"	1	14,00

ART. 3162

Valvola ad angolo per radiatori, attacco filettato maschio per tubo rame.
Angle manual valve, male thread.

Codice Code	Ø	Conf. Pack	€ cad. € each
2231007	3/8"	12	5,50
2231008	1/2"	12	5,95

ART. 3184

ECCENTRICO MF. Per attacco valvola e detentore.
MF Can used to connect the valve and the lockshield valve.

Codice Code	Ø x cm	Conf. Pack	€ cad. € each
0220451	3/8"x1	10	5,50
0220452	3/8"x2	10	4,95
0220453	3/8"x3	10	5,15
0220454	3/8"x4	10	5,35
0220455	3/8"x5	10	5,60
0220551	1/2"x1	10	5,50
0220552	1/2"x2	10	5,00
0220553	1/2"x3	10	5,15
0220554	1/2"x4	10	5,35
0220555	1/2"x5	10	5,60



ART. 3280

Tappi per radiatori zincati con flangia Ø 42 - 48 - 56.

Galvanised radiator steel caps.

Codice Code	Ø	Conf. Pack	€ cad. € each
x alluminio Ø 42			
1169310	42 chiuso DX	10	1,07
1169306	1"x1/4"	10	1,16
1169307	1"x3/8"	10	1,16
1169308	1"x1/2"	10	1,16
x ghisa Ø 48			
1169360	48 chiuso SX	10	1,07
1169356	1"x1/4"	10	1,16
1169357	1"x3/8"	10	1,16
1169358	1"x1/2"	10	1,16
x tubolare Ø 56			
1169060	48 chiuso SX	10	1,07
1168756	1"x1/4"	10	1,22
1168757	1"x3/8"	10	1,22
1168758	1"x1/2"	10	1,22
1168759	1"x3/4"	10	1,43
x tubolare Ø 56			
1168961	56 chiuso DX	10	1,96
1168656	1"1/4x1/4"	10	2,23
1168657	1"1/4x3/8"	10	2,23
1168658	1"1/4x1/2"	10	2,23
1168659	1"1/4x3/4"	10	2,44
1168660	1"1/4x1"	10	2,44
x tubolare Ø 56			
1169061	56 chiuso SX	10	1,96
1168856	1"1/4x1/4"	10	2,23
1168857	1"1/4x3/8"	10	2,23
1168858	1"1/4x1/2"	10	2,23
1168859	1"1/4x3/4"	10	2,44
1168860	1"1/4x1"	10	2,44



ART. 3282

Tappi per radiatori bianchi con flangia Ø 42-48.

White radiator steel caps.

Codice Code	Ø	Conf. Pack	€ cad. € each
x alluminio Ø 42			
1169410	42 chiuso DX	10	1,23
1169406	1"x1/4"	10	1,43
1169407	1"x3/8"	10	1,43
1169408	1"x1/2"	10	1,43
x ghisa Ø 48			
1169460	42 chiuso SX	10	1,23
1169456	1"x1/4"	10	1,43
1169457	1"x3/8"	10	1,43
1169458	1"x1/2"	10	1,43
x ghisa Ø 48			
1169480	48 chiuso DX	10	1,42
1168406	1"x1/4"	10	1,62
1168407	1"x3/8"	10	1,62
1168408	1"x1/2"	10	1,62
1168409	1"x3/4"	10	1,82
x ghisa Ø 48			
1169490	48 chiuso SX	10	1,42
1168456	1"x1/4"	10	1,62
1168457	1"x3/8"	10	1,62
1168458	1"x1/2"	10	1,62
1168459	1"x3/4"	10	1,82



PER RADIATORI ALLUMINIO E TUBOLARI

ART. 3284

Tappi per radiatori alluminio e tubolari con guarnizione EPDM bianchi Ø 42-56.

Aluminium and tubular white radiator steel caps with EPDM ring.

Codice Code	Ø	Conf. Pack	€ cad. € each
x alluminio Ø 42			
1168310	42 chiuso DX	10	1,61
1168306	1"x1/4"	10	1,81
1168307	1"x3/8"	10	1,81
1168308	1"x1/2"	10	1,81
1168360	42 chiuso SX	10	1,61
1168356	1"x1/4"	10	1,81
1168357	1"x3/8"	10	1,81
1168358	1"x1/2"	10	1,81
x tubolare Ø 56			
1169461	56 chiuso DX	10	3,23
1169462	1"1/4x1/4"	10	3,62
1169463	1"1/4x3/8"	10	3,62
1169464	1"1/4x1/2"	10	3,62
1169465	1"1/4x3/4"	10	4,03
1169466	1"1/4x1"	10	4,90
x tubolare Ø 56			
1169471	56 chiuso SX	10	3,23
1169472	1"1/4x1/4"	10	3,62
1169473	1"1/4x3/8"	10	3,62
1169474	1"1/4x1/2"	10	3,62
1169475	1"1/4x3/4"	10	4,03
1169476	1"1/4x1"	10	4,90



ART. 3286

Nipples nero Dx-Sx.

Black right and left side nipples.

Codice Code	Ø	Conf. Pack	€ cad. € each
1169110	1"	100	0,78
1169111	1"1/4	100	1,14



ART. 3300

Confezione tappi per radiatori bianchi c/guarnizione EPDM. Composta di: 2 riduzioni dx, 2 sx, 1 valvolina sfciato e tappo in ottone. Totale 6 pezzi.
Packaging including aluminium and tubular radiator EPDM ring white caps which is made up of 2 right-hand reducers, 2 left-hand reducers, 1 air valve and 1 brass cap. Total: 6 pieces.

Codice Code	Ø	Conf. Pack	€ cad. € each
1168487	42x1-3/8"	10	5,60
1168488	42x1-1/2"	10	5,70
1168489	48x1-3/8"	10	6,60
1168490	48x1-1/2"	10	6,60
1168497	56x1"1/4-3/8"	10	12,20
1168498	56x1"1/4-1/2"	10	12,20

ART. 3302

Valvoline sfciato in ottone cromato tipo pesante c/volantino plastica.

Plastic hand-wheel heavy chromium-plated brass air valves.

Codice Code	Ø	Conf. Pack	€ cad. € each
1169506	1/4"	100	0,82
1169507	3/8"	100	1,15



ART. 3304

Valvolina sfciato in ottone cromato con guarnizione teflon.
Teflon seal brass air valves. Teflon seal brass air valves.

Codice Code	Ø	Conf. Pack	€ cad. € each
1169516	1/4"	100	1,10
1169517	3/8"	100	1,30
1169518	1/2"	100	1,74



**ART. 3310**

Mensole per radiatori in ghisa verniciate bianche. Tassello Ø 16x90.

White bracket for cast iron radiators.

Codice Code	Per Colonne Risers	Conf. Pack	€ la coppia € per pair
0260252	2-3	25	2,60
0260253	3-4	25	2,80
0260255	4-5	25	3,05

**ART. 3312**

Mensole per radiatori alluminio e termoarredo bianche. Tassello Ø 10x80.

White bracket telescopic for aluminium radiators.

Codice Code	cm	Conf. Pack	€ la coppia € per pair
0260247	17x7	50	1,40
0260249	19x7	50	1,54

**ART. 3314**

Mensole piatte per radiatori alluminio verniciate bianche. Tassello Ø 10x80.

White flat bracket telescopic for aluminium radiators.

Codice Code	Ø	Conf. Pack	€ la coppia € per pair
0260267	7x170	50	1,50
0260269	7x190	50	1,65

**ART. 3316**

Mensole per radiatori tubolari verniciate bianche. Tassello Ø 12x80 mozzo Ø 63.

White bracket telescopic for tubular radiators.

Codice Code	Per Colonne Risers	Conf. Pack	€ la coppia € per pair
0260237	2	40	2,30
0260239	3-4	40	2,45
0260242	5-6	30	2,75

**ART. 3318**

Mensola per lavabi a colonna.

Column sink bracket.

Codice Code	Conf. Pack	€ la coppia € per pair
0263002	10	5,40

**ART. 3320**

Coppia mensole plastificate per lavelli, lavatoi, vaschette.

Sink, washtub and bathtub plasticised brackets.

Codice Code	Ø	Conf. Pack	€ la coppia € per pair
0262834	Cm. 34	10	14,00
0262846	Cm. 46	10	15,50

**IN RAME****ART. 3322**

Collari in rame con tassello.

Supports for tubes in copper.

Codice Code	Ø	Conf. Pack	€ cad. € each
0268460	10	20	1,82
0268462	12	20	1,87
0268464	14	20	1,90
0268466	16	20	1,95
0268468	3/8"-18	20	2,00
0268472	1/2"-22	20	2,10
0268478	3/4"-28	10	2,25
0268485	1"-35	10	2,60

**ART. 3324**

Supporti per tubi da Ø 50 sino a 200.

Supports for tubes which range from Ø 50 to 200.

Codice Code	Ø	Conf. Pack	€ cad. € each
0267904	Bianco/White	10	8,90
0267902	Zincato/ Galvanised	10	9,20

**ART. 3326**

Collare per tubo verniciato bianco M. 8x20.

M. 8x200 white-painted bracket.

Codice Code	Ø	Conf. Pack	€ cad. € each
0267958	80	10	8,80
0267960	100	10	9,80

**ZINCATO****ART. 3328**

Collari reggitubo tipo pesante Vite M8x90.

Per Ø 2" 1/2-3"-4" Vite M10x120.

Iron pipe heavy plug hose clamps.

Codice Code	Ø	Conf. Pack	€ cad. € each
0268207	3/8"	10	0,70
0268208	1/2"	10	0,72
0268209	3/4"	10	0,76
0268210	1"	10	0,80
0268211	1"1/4	10	0,90
0268212	1"1/2	10	0,94
0268213	2"	10	1,00
0268214	2"1/2	5	2,05
0268215	3"	5	2,32
0268217	4"	2	2,60

**ART. 3330**

Collare per tubi con sgancio rapido.

Quick release pipe collar.

Codice Code	Ø	Conf. Pack	€ cad. € each
0269207	3/8"	10	1,15
0269208	1/2"	10	1,16
0269209	3/4"	10	1,22
0269210	1"	10	1,30
0269211	1"1/4	10	1,45
0269212	1"1/2	10	1,50
0269213	2"	5	1,62