

**GROHE'S VICE PRESIDENT
OF DESIGN MICHAEL SEUM
TALKS ABOUT THE
NEW COLOUR TRENDS**

A FASCINATING NEW
COLLECTION TO EXPLORE

**THE SECRET OF SPA COLOURS:
GROHE PVD TECHNOLOGY
EXPLAINED**

**FREEDOM
OF CHOICE**
GROHE SPA COLOURS



When it comes to perfect bathroom design, the ultimate guide should be your own personal style. At GROHE, we want to enable you to put your vision into reality. That's why we developed the GROHE SPA Colours. The combination of our outstanding design lines and exclusive colours gives you the ultimate freedom of choice to perfectly express your individuality.

Whether you like a tone-on-tone colour scheme, prefer a harmony of contrasting colours, enjoy seeking out the shining golden beauty of cool sunrise or are fascinated by the intriguing elegance of brushed hard graphite, GROHE SPA Colours are the perfect choice. A carefully selected range of 10 colours and finishes will give you countless options to complement your interior design.

But there is more to it than just the obvious beauty. Our new colours come with GROHE PVD quality. This outstanding finish ensures both maximum colour brilliance as well as unparalleled material resistance. We simply call it GROHE StarLight – so that they are guaranteed to look as beautiful decades on as they did the day you first fell in love with them.

Our GROHE SPA colours are not driven by fashion. They open new dimensions to expressing your very own personal style in bathroom design. Faucets, showers and accessories are all perfectly aligned in your preferred colour with GROHE quality to stay perfect in finish and function for the years to come.

We hope, you will enjoy the perfect freedom of choice.

Michael Rauterkus
Chief Executive Officer Grohe AG

CONTENTS

09

MICHAEL SEUM presents the trending colours in the home

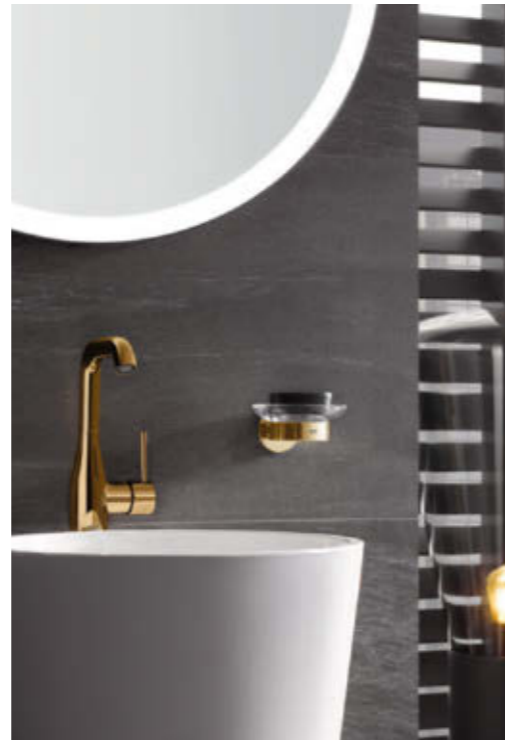

47

ESSENCE - the collection that gives you freedom of choice

37

GROHE PVD TECHNOLOGY
in all its ingenious details



57

TAREK HEGAZY explains his fascination with GROHE Essence



61

GROHE ALLURE BRILLIANT - every piece as beautiful as a diamond

71

GRANDERA - the definition of tomorrow's grand style



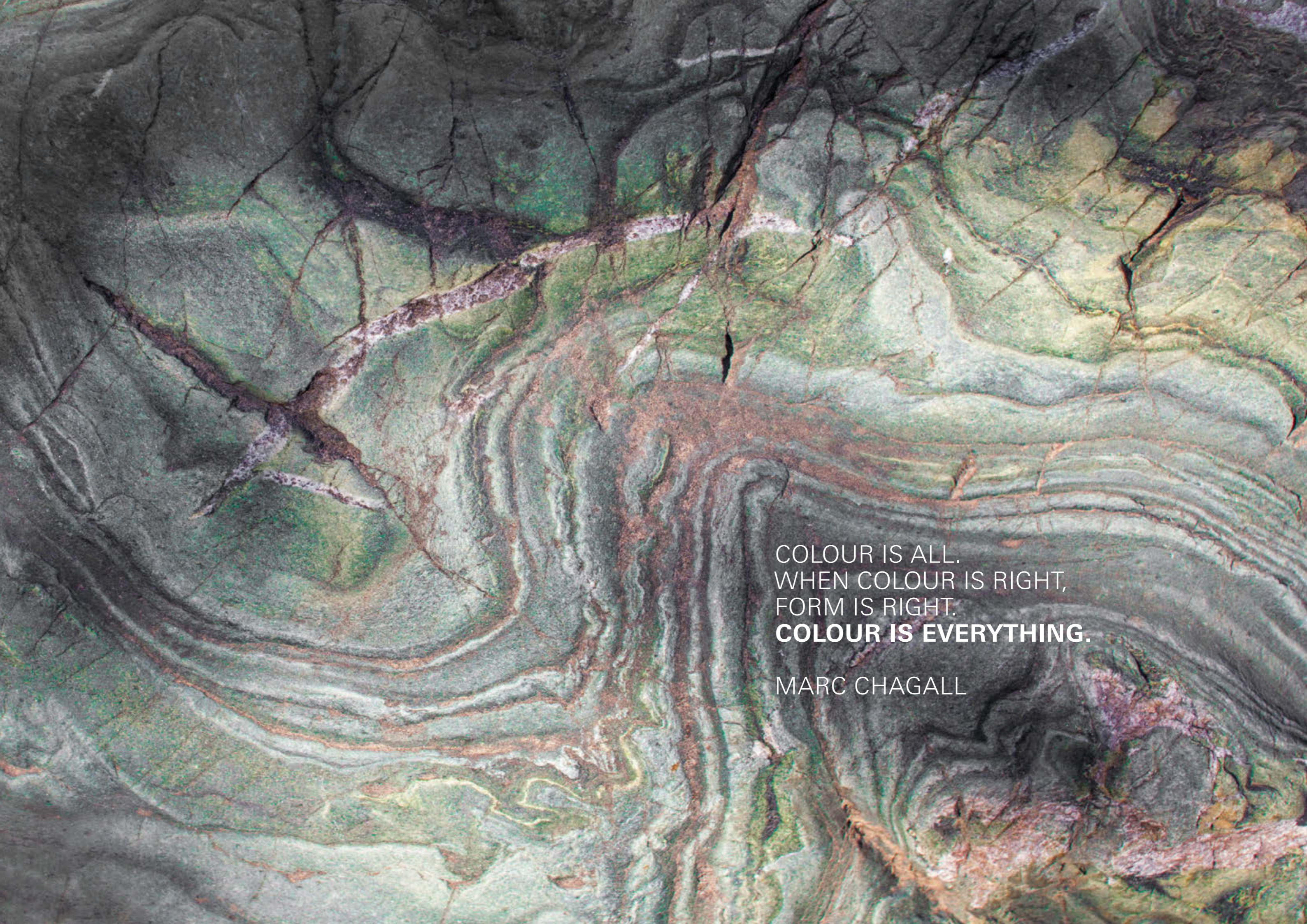

COLOUR IS ALL.
WHEN COLOUR IS RIGHT,
FORM IS RIGHT.
COLOUR IS EVERYTHING.

MARC CHAGALL



» THESE **NEW OPTIONS**
ARE AN INCREDIBLY
RICH TOOLBOX FOR
THE CREATIVE MIND«

Michael Seum
Vice president design

At GROHE, Michael Seum is responsible for insight-driven designs that capture the spirit and imagination of designers throughout the world. With GROHE SPA Colours, he and his team created a powerful palette of long-lasting, high quality colours that harmonise with every project.

»THE INTERACTION OF THE COLOURS WITH THEIR SURROUNDINGS IS TRULY FASCINATING«

What role do colours play in your work?

Colour is incredibly important. Having said that, if you ask ten people about their opinion of colours you get 15 different answers. We all respond to colour differently. In the kitchen and bath - when somebody makes an investment in colour, it's not like wall paint, where that can be changed quickly. So our approach to colour, finish and materials is to ensure relevance in the home for many years to come - this is what we call design permanence. The GROHE SPA Colours have been carefully curated to ensure our customers have a rich toolbox and most importantly the freedom to create their desired vision.

Where do you get your inspiration from when you create a finish?

The team and I attend major design fairs globally, for example the ICFF in New York, Maison&Objet in Paris, the Tokyo and London design weeks and Salone del Mobile in Milan. So we definitely get our inspiration from the cutting edge of the design world.

When we're at these design fairs, we're not looking specifically at our industry. We look at movements within the home sector, like the furniture industry. And then we're responding to that with this selection of colours and finishes. With our range of colours, we want consumers to see that they have unlimited design flexibility with our collection. There's a lot in the industry where they just pick up on a trend but fads and fashion just disappear. Even the quality is poor. At GROHE, we have a more balanced approach. When you buy a GROHE product

it's about quality, technology, sustainability and design. You know this colour and finish is on the cutting edge of interior trends and at the same time it will last, due to our higher quality standards.

What differentiates the GROHE SPA Colours from colour, as we typically perceive it?

We could have gone after colours that were not such long-standing trends. They might be around for one or two years. But the problem there is when you're working with bath interiors, these are fixtures - once installed they are there for a long period of time. We have to be really selective around the appropriateness of the colour and how it's used. And I think there are other areas, where if you wanted to bring colour into the bathroom, you can do that - with lighting as well. That's why we've taken an approach where the colour is a long-standing trend. And we've seen the warm finishes now year after year, in Milan and London. It's now an accepted colour and finish strategy. But it's not to say that we won't have more unique finishes coming up during the process of developing the next generation of colours.



Throughout the year Michael Seum and his design team visit several fairs in the world to find long-lasting trends in the furniture industry. Looking beyond the sanitary industry they focus on emerging trends in interior design - to create products that inspire GROHE's consumers, not simply following the latest fashion.



The warm colours are a long-lasting trend in the whole world: one of the inspirations behind GROHE's new finishes.



photo credit: Massimo Gardone



» WE SEE THE **WARM COLOURS** COME INTO THE HOME MORE AND MORE«

How has the use of colours in design developed over time?

I think colour has always been part of the interior design world, but it has evolved over the years. One thing we're seeing from our visits at the design fairs, is that year after year, the warm colours come into the home. That is now an established design trend that came more out of the Nordics first, but is relevant everywhere now. Globally, colours develop differently. The US market is very colour-centric, but leans more to the classic colours. Asia is also very colour oriented. The Middle East loves the warm and the golds. And in Europe we've seen the warm colours come in but also the Brushed Nickel and Graphite are inspiring many designers. I think the use of colour has taken off differently. The challenge here is we had to put together a palette that works around the world. And with the new colours and finishes we've been able to achieve that.

How do colours influence the way we perceive the bathroom?

I think the way colour, finish and material impacts the bathroom is that the faucet becomes the jewellery - the accessory for the interior designer. It's another way to add a level of detail and quality to interior design features. And our colours have been selected and curated in a way that allows you to almost do anything you need to with them. So if you want high contrast, mid tones or low contrast, you can really use your colours to influence the outcome. This is a palette that gives you the complete flexibility to work with.

And what about the kitchen?

Most kitchens are white. The way consumers add colour is through accessories - like toasters, blenders, coffee makers. Because they can put them on the counter and take them away. So we thought, if someone had that red iconic kitchen mixer then they're more likely to take that vivid red hose of Essence. But there's really no risk in that because they can upgrade it, they can change it easily. In the bathroom, we've taken a slightly more refined approach, because there isn't yet a quick way to accessorise with colour.

All of the GROHE SPA Colours work in the kitchen and in the bathroom very well.

» OUR COLOURS FIT INTO ENVIRONMENTS OF EVERY CONTRAST «

Do you have a personal favourite amongst the GROHE finishes?

Yes, the Brushed Hard Graphite. Which is, by the way, the most sophisticated finish we have right now. I'm in the process of redoing my kitchen all black on black and I'm going with that finish.

What are the rules for choosing finishes for the bathroom?

To be honest, there are none. I think we're in a day and age where designers are much more free to do what they want. With our opened up colour and finish options in this collection, we've given them no rules. There are just endless possibilities to work with here. If I had to suggest one rule, it would be to coordinate the finishes. Because there's nothing worse than going into a space and having a different colour faucet, a different colour shower, a different colour towel holder. And with GROHE SPA Colours you get the full coordination of whatever colour and finish you need.

What can you tell us about the interactions of shapes, surfaces and finishes?

The way we've articulated this design range to the design world is: you have three types of environment. You have high-contrast environments and you have tone-on-tone environments. And in the middle you have mid-tones. Let's say I was designing an all-black bathroom. I have more or less some options. But if I wanted black tile on the wall, I could pick the opposite of it, which would be chrome to give it a more contrary contrast finish. Or if I wanted the whole bathroom to be a soft matt finish,

I can use the brushed surface. So in terms of the interactions of shapes and surfaces, it all depends on what the interior design strategy is. But that's why we've offered a polished and a brushed finish to give you that flexibility in your interactions. And this rings true for all colours, available in polished or brushed.

Can you give us an example?

When I say the word vintage you think of the brushed gold, but when I say luxury you think of the polished gold. It's the same colour, it's just a finish difference. By just changing the finish, I can give you a different verbal cue of vintage vs. luxury. The reason we have a brushed and a polished is to allow the ultimate flexibility between the interior strategies.



The play with contrasting black and white is currently trending at design fairs. And the GROHE SPA Colours collection helps to create the perfect outcome.



INSPIRED FORM
MEETS INSPIRING
COLOUR

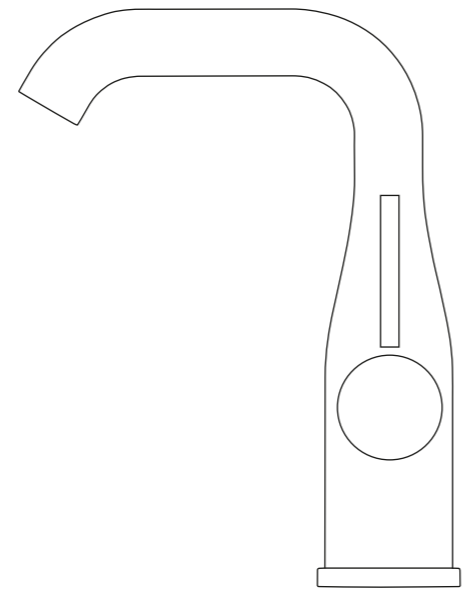

ESSENCE

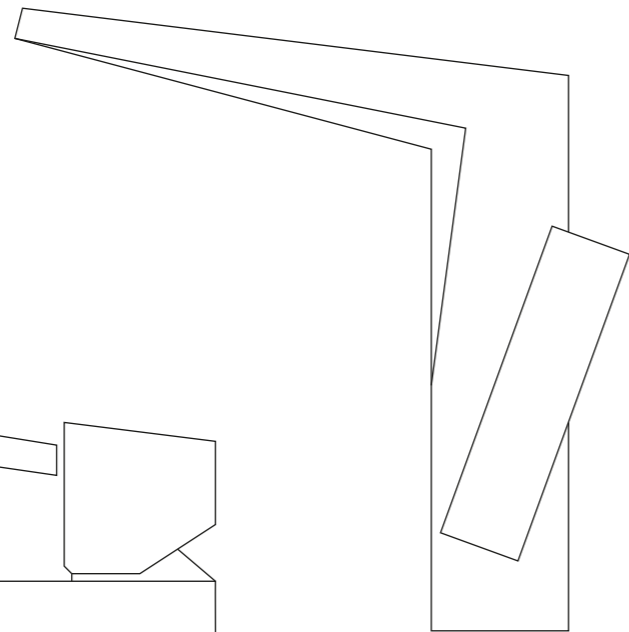

ALLURE BRILLIANT

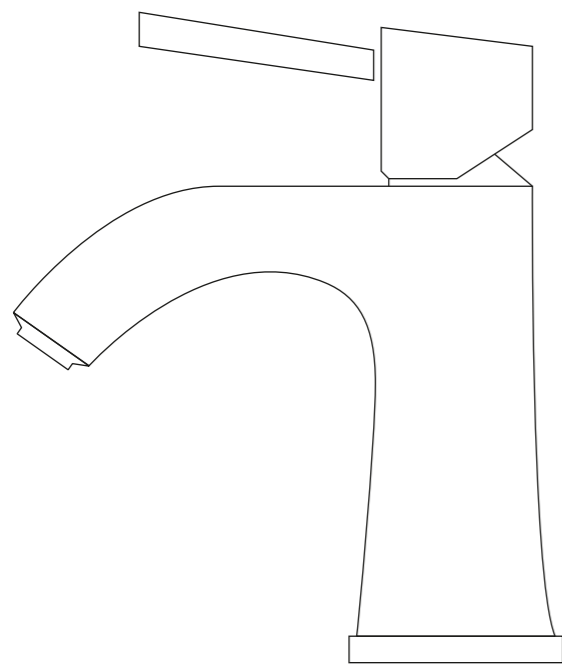

GRANDERA

POLISHED SURFACE



Hard Graphite



Warm Sunset



Cool Sunrise



Polished Nickel



Chrome

BRUSHED SURFACE



Brushed Hard Graphite



Brushed Warm Sunset



Brushed Cool Sunrise



Brushed Nickel



SuperSteel

HARD GRAPHITE

POLISHED & BRUSHED SURFACE





WARM SUNSET

POLISHED & BRUSHED SURFACE

COOL SUNRISE

POLISHED & BRUSHED SURFACE





NICKEL

POLISHED & BRUSHED SURFACE

SUPERSTEEL

POLISHED & BRUSHED SURFACE



ALLURE BRILLIANT

A UNIQUE COMBINATION
OF FORM AND FEEL

ESSENCE

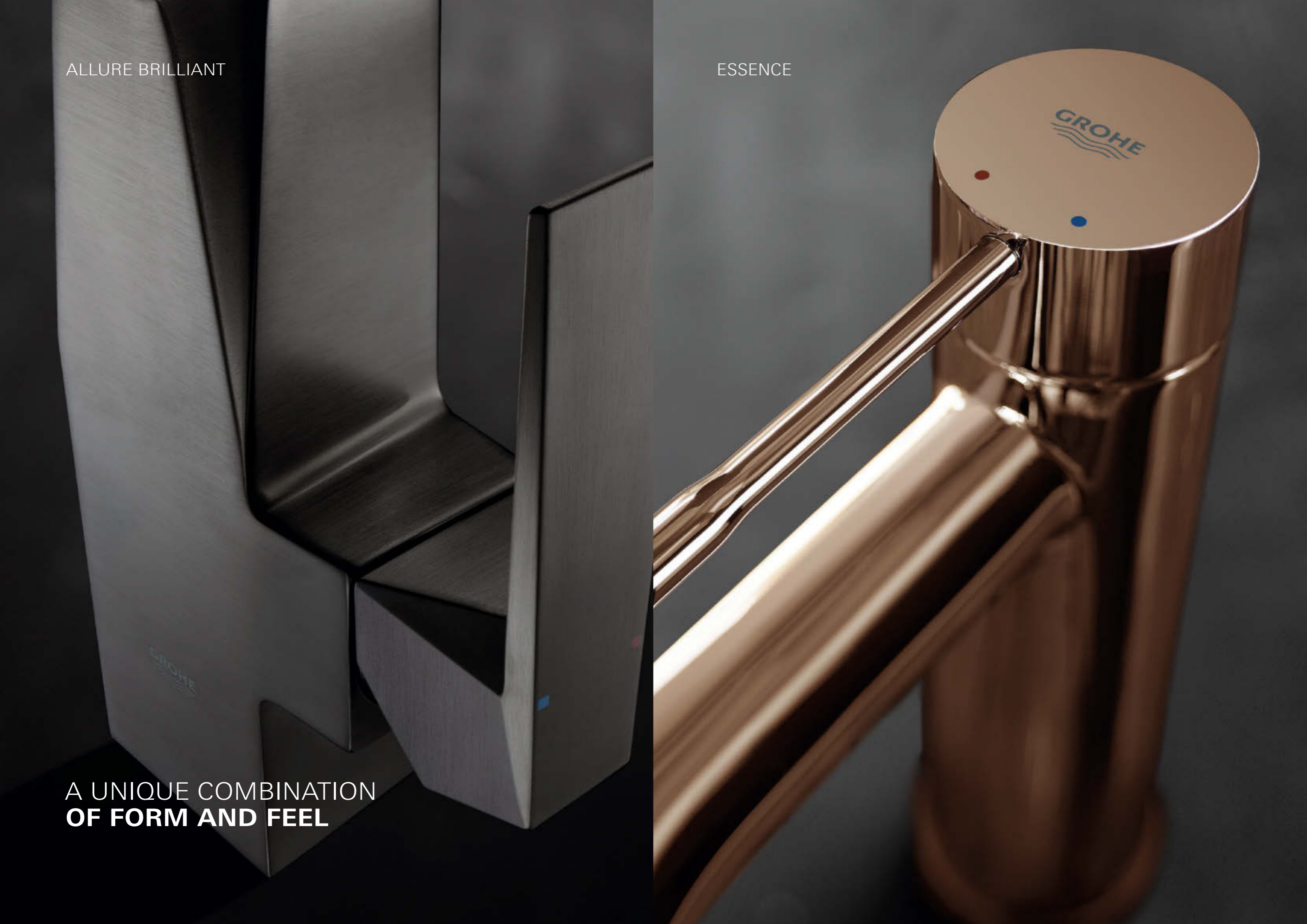



YOUR FREEDOM
OF CHOICE

GRANDERA



WHEN SLEEK GLIDING
FORMS **MEET SILKY**
SMOOTH SURFACES

**A FASCINATING NEW
COLLECTION TO EXPLORE**

GROHE



THE WHOLE SECRET OF
THE STUDY OF NATURE
LIES IN LEARNING **HOW**
TO USE ONE'S EYES...

GEORGE SAND

THERE'S NO SUBSTITUTE FOR
SUPERB CRAFTSMANSHIP AND
THE DESIRE TO DO A JOB WELL



HOW DOES PVD WORK?



When it comes to a good design strategy, the choice of colours plays a vital part. But not only the colour, the quality of the finish is equally important. Especially in the world of bathroom and kitchen solutions and where surfaces ought to last for a long time, excellent, highly resistant finishes distinguish good products from great ones. GROHE's aspiration to always produce only the best drove us to choose a special technology that assures, not simply the best, most brilliant colours, but a durable coating of the highest quality.

OUR HIGH-END PVD TECHNOLOGY BRINGS OUR NEW COLOURS TO LIFE

Our aim: to offer our consumers long-lasting water enjoyment. Next to the resistance of the material, it was also about the look of the colour itself: we wanted to make brushed hard graphite as dark grey as possible and give our golden finishes the brilliance they deserve. That was the task for our technology team. In close collaboration with the GROHE design team, they achieved exceptional results working with a great new technology: PVD.



PVD stands for Physical Vapour Deposition. This innovative technology, that has its origins in the space programme, has established a new standard in surface quality by using the deposition of plasma particles. At GROHE, we have perfected this process and applied it to our products. This technique has achieved its high point in the creation of GROHE SPA Colours.

WE USE THE STRENGTH
OF PLASMA PARTICLES





WHAT YOU GET WITH YEARS OF OUTSTANDING GROHE QUALITY AND PAINSTAKING EFFORT

This technology is divided in two major steps: Pretreatment and PVD coating.

The first step, pretreatment, refers to the thorough cleaning of the faucets. They are positioned on racks and hung in cleaning baskets. Now, the faucets undergo a special cleaning process, using acid & alkaline cleaning media. This is followed by thorough drying in a vacuum. After this procedure, the parts are micro purified and are removed from the cleaning line. They are then transported into the PVD coating area. Here, the air is conditioned to about 50 percent relative air humidity and to an ambient temperature of around 25°C. Here the racks are taken out of the cleaning baskets and loaded on dedicated PVD racks, which are then placed on a coating table. After this, the parts get heat treated in an oven. Here, plastic parts go through a degasification process. The retention time is at least three hours. Metal parts are heated up and require at least one hour. Now a product carrier transports the dried and heated components into the PVD machine.

The second step is the PVD coating. After the door of the PVD chamber has been locked, the program-sequence starts and the target material gets evaporated. This coating process takes place in a high-vacuum environment and consists of three steps: first the substrate cleaning, then the primer coating and at last the color coating. To realize different colors, reactive gasses like nitrogen and acetylene are added to the target material zirconium. The time required for a coating depends on the process and takes between one and two hours. After the coating, the table gets finally moved out of the PVD machine via the product carrier. In the last step, every product is carefully controlled for defects before they are packaged and delivered to stock.

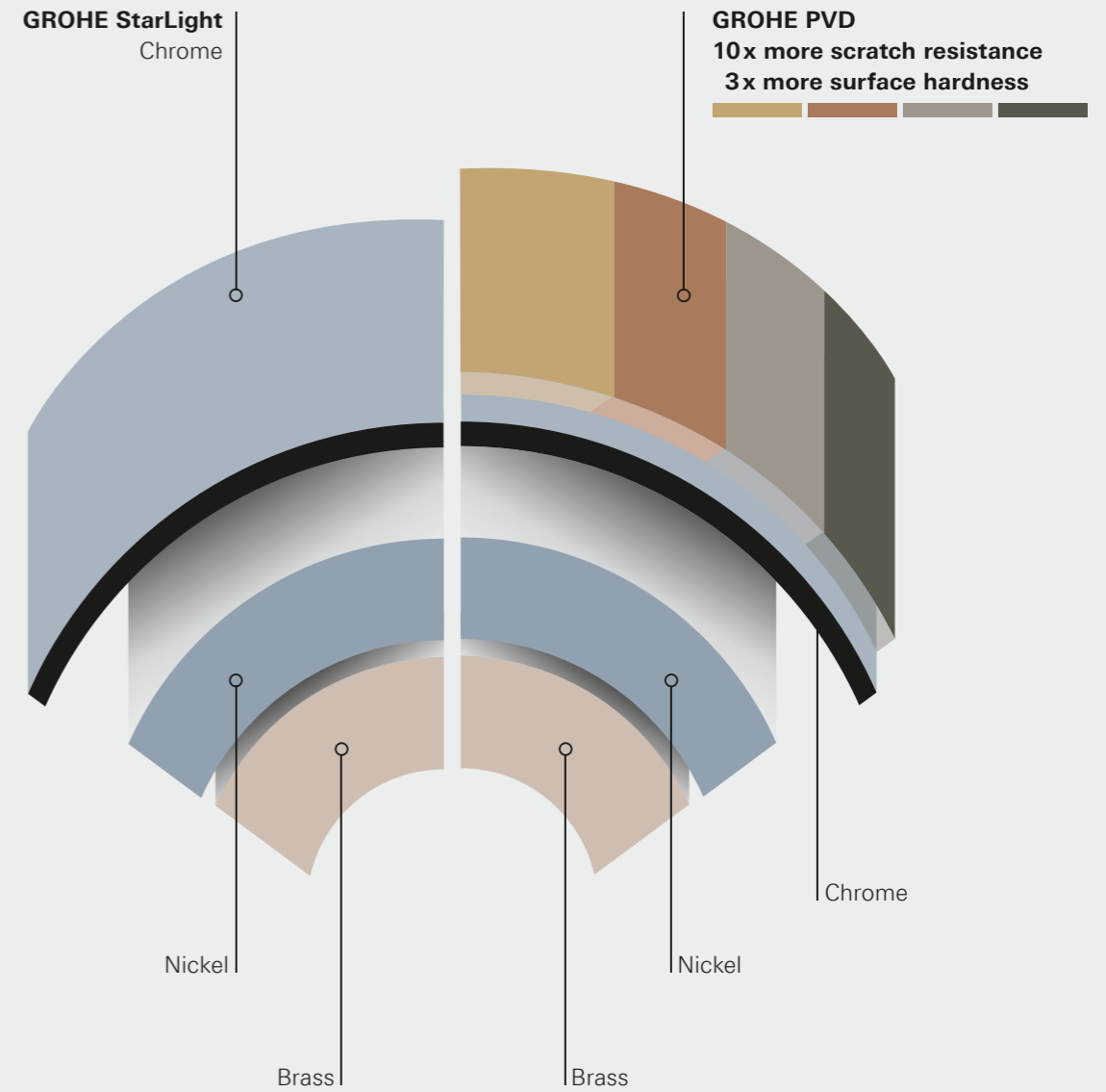

UNIQUE GROHE CRAFTSMANSHIP IN EVERY LAYER

WHY IS A PVD COATING SUCH A VASTLY SUPERIOR FINISH?

The new colours of our GROHE SPA Colour collection are produced with PVD technology. Now what makes GROHE's PVD technology so much better than common chrome plating? To begin with, all PVD coated colours are extremely uniform because of the absolute evenness of every layer.

Unlike normal electro-plated finishes with their very limited range of colours, our PVD finishes offer you flexibility and choice with the wide range of colour options. You can simply choose the one that suits your interior design strategy best. With our PVD coated products, we not only created highly aesthetic colours, we also made these colours

more durable than ever. The adhesion of the coating plays a vital role in ensuring a beautiful and long lasting finish. Our PVD process achieves six times greater adhesion. An ordinary electro-plated surface just can't compete. All our faucets are highly resistant to abrasion and resilient to hard knocks. This guarantees that our consumers will enjoy using these high quality faucets and mixers for years and years to come.

At GROHE we are not only passionate about bathrooms and kitchens, we also care about the environment. In order to be as environmentally friendly as possible, we use no harmful chemicals in our PVD technology.



All our PVD finishes are highly resistant to abrasive cleaning materials.

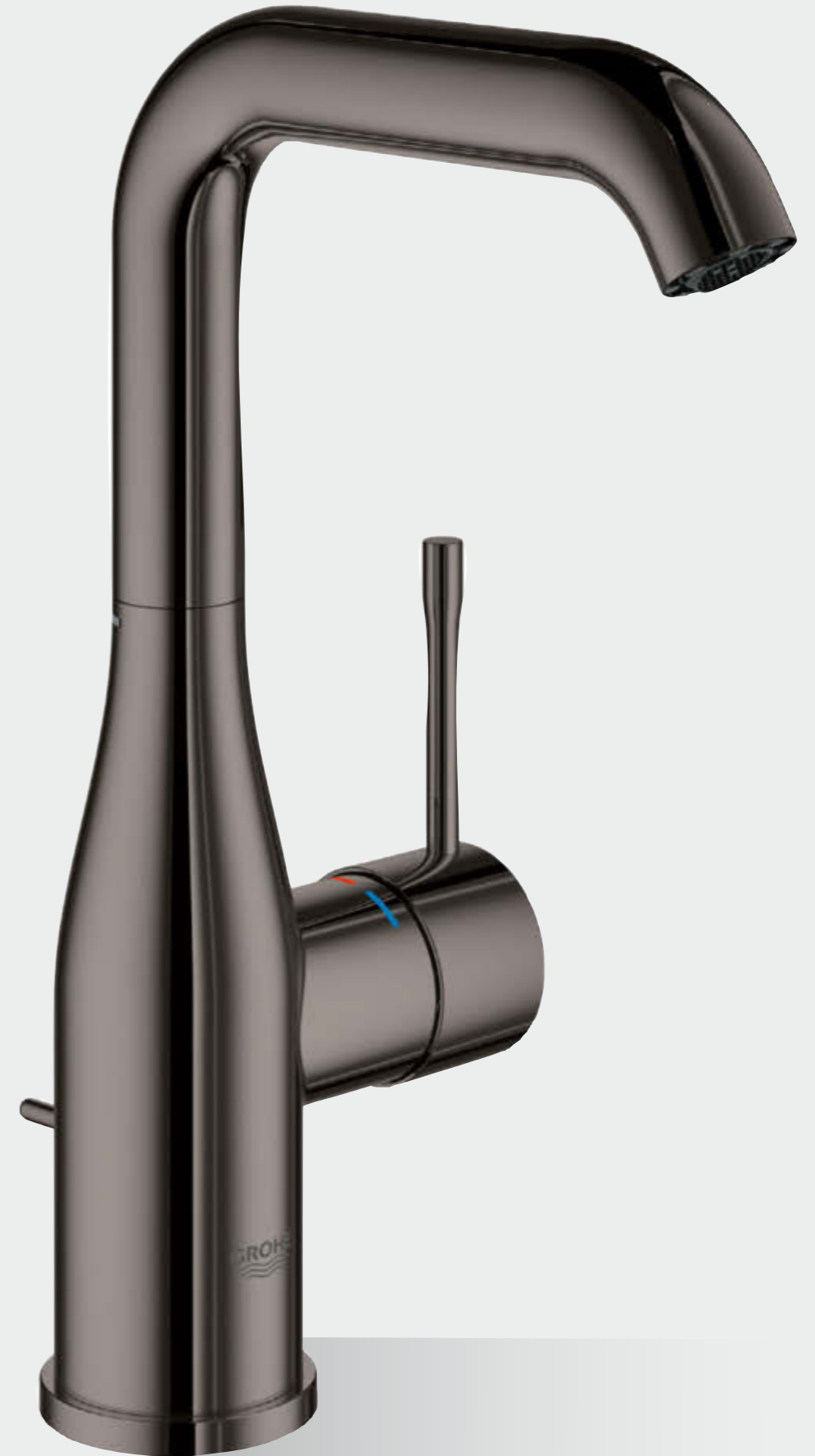



EVERY FORM IS
A BASE FOR COLOUR,
EVERY COLOUR IS
THE ATTRIBUTE OF A FORM

VICTOR VASARELY

FREEDOM OF CHOICE

GROHE ESSENCE OFFERS
A FASCINATING VARIETY TO
CHOOSE FROM.





A luxurious variety of premium products that fascinates with a modern and elegant design: that is the philosophy behind Essence. Be inspired by the two high quality finishes of Essence: the classic elegance of polished surfaces and the modern purity of brushed surfaces. Essence offers you a richness of choice for your projects, promising you everything you need to create the most captivating design compositions: more elegant finishes, more inspiring colours and more luxurious materials. Select the combination that fits perfectly to the bathroom you are creating. The updated Essence line now comes in 10 colours, giving you more options than ever to express your ideas.

ONE PRODUCT LINE
ONE FASCINATING DESIGN





GROHE ESSENCE
COMES IN TEN HIGH
QUALITY FINISHES –
EACH WITH ITS OWN
BEAUTY

Time and again, Essence incorporates the cylindrical form in exciting ways. An artful play of shapes recurs throughout the range, from luxurious showers to architecturally-shaped washbasins and radiant fittings which are available in various sizes. For people who are attracted by clear, visually pleasing designs, Essence offers aesthetics without pretension. The complete bathrooms in this range use balanced, modern styling and create space for your inventive furnishing ideas and GROHE's innovative technologies.

The minimalistic design of the Essence collection is a feast for the eye, whilst employing modern technology.



Hard Graphite



Hard Graphite

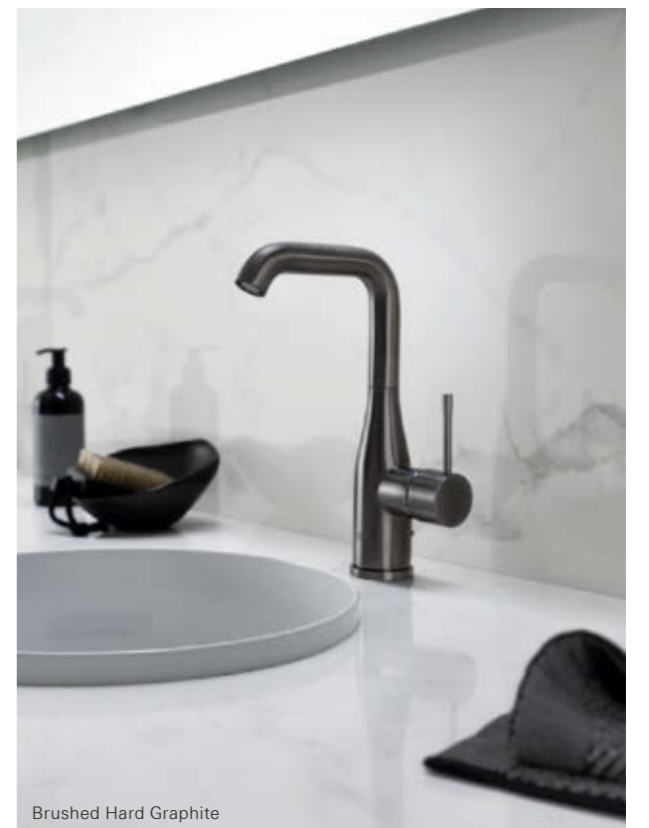

Brushed Hard Graphite



Brushed Nickel

A CLASSIC LIFESTYLE THAT IS SUBTLY INTERPRETED

When it comes to choosing the right faucet for your project, one detail can make all the difference. Take Essence for example: its tactile control lever with its slight taper, gives the user a sensual experience of precision control. The new lever suggests an air of symmetry as its changing diameter uses the same curvatures as the water delivery column. By sharing the same profile, they create a sense of unity. What's more, when you move the control lever to release the water flow, you'll notice a totally smooth sensation: organic form meets perfect technology.

Who would have thought that turning a faucet on and off could bring so much pleasure? Details like this help make an excellent product into a truly outstanding one. They represent the final 1% of the design, which is often the most elusive.



» GROHE ESSENCE COMPLETELY REJUVENATED MY CREATIVE PALETTE«

Tarek Hegazy
Principal & Creative Director, Living Design Sweden

How will you use these extended options?

Mixing colours and finishes in sanitary ware has never been attempted on a commercial scale before. But that's exactly what GROHE has done with the Essence range, and it will enable me to bring new individuality, emotion and fashion to the bathroom. Now I can pursue meaningful personalisation. And all whilst using the same fundamental design – I have the best of both worlds – consistency and familiarity mixed with variation and surprise. A paradoxical combination that is perfect for the hospitality environment.

How important is this choice?

It is important to have customisation and distinction, while remaining united around a core value – that's basically the real value that GROHE is providing. The new options give us the wings to fly, in other words, they give us the chance to create visual distinction without sacrificing the core value of the Essence quality and functionality. I believe that the Essence range will change the way we dress the bathroom and kitchen. It will change the way we interact with those spaces and the delight we have with water. That's because Essence not only brings emotion to those spaces, it also appeals to the individuality of the designers.

Which comes first, faucet or ceramic?

Faucets are the "crown jewels". For the designer, they are the "crème de la crème" of any bathroom or kitchen design. With a careful selection, the whole bathroom or kitchen comes alive with distinction.

Tarek Hegazy

With over 26 years of experience and numerous prestigious projects in his portfolio, and more than 200 projects to his credit, the majority being five star hotels, Tarek Hegazy, is Principal and Creative Director of his company, Living Design, a Swedish-based International Interior Design firm established in 1984. The firm is considered by its peers to be one of the leading interior design firms in Europe and has earned more than 120 awards.



COLOUR IS SENSIBILITY
IN MATERIAL FORM, MATTER
IN ITS PRIMORDIAL STATE

YVES KLEIN

LIKE A DIAMOND

THE LUXURIOUS DESIGNS
OF **GROHE ALLURE BRILLIANT**
REFINE EVERY BATHROOM



Hard Graphite



THE PINNACLE OF ULTIMATE BATHROOM LUXURY AND SOPHISTICATION

Crisp planes, intriguing angles and cut-out details, GROHE Allure Brilliant illustrates the absolute precision that can only be achieved through years of experience and an unfaltering passion for innovation. Complex without being complicated, its faceted mixers add a new dimension to bathroom design and a new dimension to water. With its gem-like quality and structured shape GROHE Allure Brilliant exudes architectural appeal. Our designers and engineers have taken on the roles of lapidaries, refining and polishing with utmost care to create a collection of intriguing designs, which will challenge your perception of bathroom fittings.

We have specially formed the wall-mounted spout in the shower so that it dispenses water at just the right angle - both for filling a bathtub and enjoying a shower. The water flowing from the spout forms a natural, wide and even fall of water, which adds another sensual element to the spa experience. GROHE PVD technology is used to protect the brilliant and long-lasting finish against scratching and soiling. The GROHE Allure Brilliant cascade spouts for bathtubs and showers are a perfect choice for enjoying water in its most natural form.

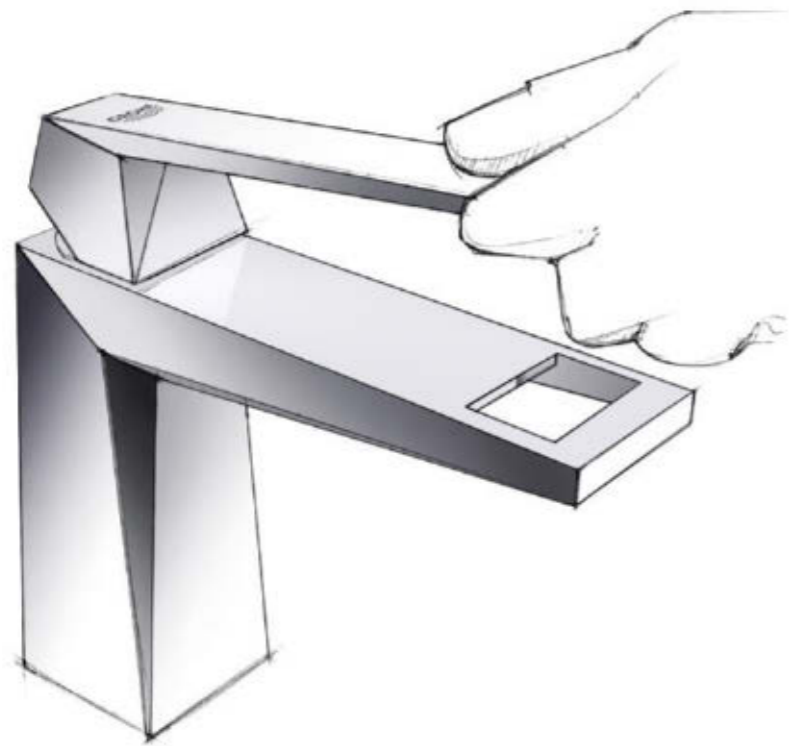

Hard Graphite





The GROHE Allure Brilliant collection offers an extensive range of premium fittings for all points of interaction in the bathroom. From the basin to the bathtub and shower, the collection offers a wide range of products, giving you the freedom to tailor the room to your clients' specific requirements. Wall-mounted, deck-mounted and even floor-mounted mixers make it easy for you to find your perfect match at the basin. And since single hand showers or head showers no longer suffice to answer modern demands, we present a complete range of integrated custom showering solutions, for a three-dimensional sensory experience. A dedicated range of accessories for design harmony throughout the bathroom completes the collection.

Warm Sunset



Cool Sunrise



Hard Graphit



FACETED SURFACES,
PERFECTLY CUT LIKE
A DIAMOND, EXCITES
WHOEVER STEPS
INTO THE BATHROOM

Inside and out, GROHE Allure Brilliant pushes the boundaries. With its confident and precise use of geometric shapes, this collection explores the pure, linear appeal of minimalist architecture to create a striking and alluring portfolio of faucets, showers and fittings. Starting with the simplicity of a square or rectangle, the GROHE Allure Brilliant Collection utilises geometric forms to their full potential. With its clean angular lines and flat planes, GROHE Allure Brilliant takes faucet design to a new and exciting level. An aperture at the end of the spout gives a new view of water – a cascading flow that entices and teases every time.



**IF GOLD MUST BE GOLD,
IT MUST PASS THROUGH
THE FURNACE**

T. B. JOSHUA

TOMORROW'S GRAND STYLE

COMBINING BOTH ROUND AND SQUARE
FORMS, **GROHE GRANDERA** CREATES
TRUE HARMONY WITHIN THE HOME





Puristic, simple and yet extravagant. Clean, square and yet round. Timeless, classic and yet modern. The GROHE Grandera collection reconciles traditional opposites in one harmonious design. The result is an exceptionally diverse collection of extremely durable fittings, thermostats, showers and accessories. For us at GROHE, design is much more than just an aesthetic accessory. We are devoted to the ideal union of form and function. To achieve this, we always try to explore new paths, as we did with GROHE Grandera. Inspired by the superellipse, our design team created the GROHE Squircle, combining the round form together with the square form. The result acts as the basis of our GROHE Grandera design.

THE HARMONIOUS UNION OF THE ROUND AND THE SQUARE FORM



GROHE's high-quality workmanship and exceptional craftsmanship are also reflected in the many decorative elements and create clean and precise shapes. The GROHE Grandera collection stands for perfection, right down to the smallest detail. The entire range, from the head shower to the thermostat and from the washbasin fitting to the ceramics, is perfectly coordinated. If you want to turn a bathroom into a place of extravagance, GROHE Grandera is the ideal choice.

Warm Sunset



Cool Sunrise



GROHE GRANDERA IS SIMPLE AND YET ELEGANT

GROHE Grandera creates the perfect light in the bathroom. The chrome finish gives the faucet a high-quality sheen, whereas the chrome/gold finish is the essence of style and comfort. Golden highlights on base, outlet and lever were made with great attention to detail and passion to extravagant design. Thanks to GROHE StarLight technology both finishes are extremely resistant to scratches and keep their brilliance for years and years to come.

With this harmonious design, you get the chance to make the bathroom a place of wellness, regeneration and relaxation. Choose for example the GROHE Grandera hand or head shower to create a completely new shower feeling. Thanks to its GROHE DreamSpray technology, the perfectly temperate water is evenly distributed through the nozzles.

The faucets themselves are a source of delightful water pleasure. With its GROHE SilkMove technology, every piece of the collection offers easy use for complete comfort.



WHEN THE COLOUR
ACHIEVES **RICHNESS**,
THE FORM ATTAINS
ITS FULLNESS ALSO

PAUL CEZANNE



●●●●●●●●●●●●●●●●●●●●
23 491 001 + 45 984 001
 Bath/shower mixer
 floor mounted
 + separate concealed body



●●●●●●●●●●●●●●●●●●●●
23 589 001
 S-Size
 Basin mixer
 with pop-up waste set

●●●●●●●●●●●●●●●●●●●●
23 462 001
 M-Size
 Basin mixer
 with pop-up waste set

●●●●●●●●●●●●●●●●●●●●
32 628 001
 L-Size
 Basin mixer
 with pop-up waste set



●●●●●●●●●●●●●●●●●●●●
32 901 001
 XL-Size
 Basin mixer
 for freestanding basins

●●●●●●●●●●●●●●●●●●●●
19 967 001 + 23 571 000
 L-Size Basin mixer, 230 mm
 + separate concealed body

●●●●●●●●●●●●●●●●●●●●
32 935 001
 S-Size
 Bidet mixer



●●●●●●●●●●●●●●●●●●●●
19 578 001
 4-hole bath combination

●●●●●●●●●●●●●●●●●●●●
33 624 001
 Bath/shower mixer

●●●●●●●●●●●●●●●●●●●●
19 285 001 + 35 501 000
 Bath/shower trimset
 + separate concealed body
19 286 001 + 35 501 000
 Shower trimset
 + separate concealed body

●●●●●●●●●●●●●●●●●●●●
33 636 001
 Shower mixer

Replace the second and third last digit and replace by the below colour code to order the coloured version.

- Colour options:**
 ● 00 | StarLight Chrome ● GL | Cool Sunrise ● DA | Warm Sunset ● A0 | Hard Graphite ● BE | Polished Nickel
 ● DC | SuperSteel ● GN | Brushed Cool Sunrise ● DL | Brushed Warm Sunset ● AL | Brushed Hard Graphite ● EN | Brushed Nickel



This is only a selection of the product range. All other products from the range are also available in SPA Colours by special production.



20 389 000 / GL0 / DA0 / A00 / AL0
L-Size
3-hole basin mixer
high spout



40 629 000 / DA0
Towel rail 600 mm



40 630 000 / DA0
Towel ring



19 937 000 / DA0 + 35 500 000
Thermostatic shower mixer
with 2 way diverter
+ separate concealed body



40 631 000 / GL0 / GN0 / DA0 / DL0 / A00 / AL0 / BE0 / EN0
Robe hook



40 625 000 / DA0
Toilet paper holder



19 920 000 / DA0 + 35 501 000
Bath/shower mixer
+ separate concealed body



23 318 000 / GL0 / DA0 / A00 / AL0 + 45 984 001
Bath/shower mixer
floor mounted
+ separate concealed body



23 303 000 / GL0 / DA0 / A00 / AL0
M-Size
Basin mixer



19 936 000 / GL0 / DA0 / A00 / AL0
4-hole bath combination

Replace the second and third last digit and replace by the below colour code to order the coloured version.

Colour options:

- | | | | | |
|-------------------------|-----------------------------|----------------------------|------------------------------|------------------------|
| ● 00 StarLight Chrome | ● GL Cool Sunrise | ● DA Warm Sunset | ● A0 Hard Graphite | ● BE Polished Nickel |
| ● DC SuperSteel | ● GN Brushed Cool Sunrise | ● DL Brushed Warm Sunset | ● AL Brushed Hard Graphite | ● EN Brushed Nickel |



This is only a selection of the product range. All other products from the range are also available in SPA Colours by special production.



40 369 001
Holder for Glass, Soap dish
or Soap dispenser



40 394 001
Soap dispenser



40 365 001
Towel ring



40 366 001
Towel rail 600 mm
40 386 001
Towel rail 800 mm
40 688 001
Towel rail 450 mm



40 371 001
Double towel bar



40 802 001
Double towel rail 600 mm



40 364 001
Robe hook



40 421 001
Grip bar 295 mm



40 367 001
Toilet paper holder
40 689 001
without cover



40 385 001
Spare toilet paper holder



40 374 001
Toilet brush set



40 800 001
Multi-towel rack 550 mm

Replace the second and third last digit and replace by the below colour code to order the coloured version.

- Colour options:**
- 00 | StarLight Chrome
 - GL | Cool Sunrise
 - DA | Warm Sunset
 - A0 | Hard Graphite
 - BE | Polished Nickel
 - DC | SuperSteel
 - GN | Brushed Cool Sunrise
 - DL | Brushed Warm Sunset
 - AL | Brushed Hard Graphite
 - EN | Brushed Nickel



This is only a selection of the product range. All other products from the range are also available in SPA Colours by special production.



●●●●●●●●●●
27 251 000 / GL0 / GN0 / DA0 / DL0 / A00 / AL0 / BE0 / EN0
 Side shower F-Series 5"
 127 mm x 127 mm
 1 spray pattern: Rain

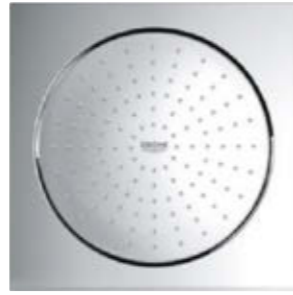

●●●●●●●●●●
27 271 000 / GL0 / GN0 / DA0 / DL0 / A00 / AL0 / BE0 / EN0
 Head shower F-Series 10"
 1 spray pattern: Rain



●●●●●●●●●●
27 477 000 / GL0 / DA0 / A00 / AL0
 Head shower Rainshower 310
 metal
 1 spray pattern: Rain



●●●●●●●●●●
26 066 000
 Head shower set Rainshower 310
 projection 380 mm
 1 spray pattern: Rain
 with 9.5 l/min. GROHE EcoJoy
26 067 000
 length 142 mm



●●●●●●●●●●
19 468 000 + 35 500 000
 Thermostatic bath/shower mixer
 with integrated 2-way diverter
 + separate concealed body



●●●●●●●●●●
27 226 001
 Shower set
 with hand shower 110 Massage
 with GROHE EasyReach tray
 rail 900 mm



●●●●●●●●●●
27 491 000 / GL0 / DA0 / A00 / AL0
 Head shower Cosmopolitan 180
 with chrome plated spray face
 1 spray pattern: Rain



●●●●●●●●●●
34 065 002
 Thermostatic shower mixer



●●●●●●●●●●
26 075 000
 Euphoria XXL 310
 Shower system with thermostat
 hand shower Euphoria 110 Massage
 450 mm shower arm

Replace the second and third last digit and replace by the below colour code to order the coloured version.

- Colour options:
- 00 | StarLight Chrome
 - GL | Cool Sunrise
 - DA | Warm Sunset
 - A0 | Hard Graphite
 - BE | Polished Nickel
 - DC | SuperSteel
 - GN | Brushed Cool Sunrise
 - DL | Brushed Warm Sunset
 - AL | Brushed Hard Graphite
 - EN | Brushed Nickel



This is only a selection of the product range. All other products from the range are also available in SPA Colours by special production.

DESIGN	PRODUCT	00	DC	GL	GN	DA	DL	A0	AL	BE	EN
ESSENCE	19 285 001	•	•	•	•	•	•	•	•	•	•
	19 286 001	•	•	•	•	•	•	•	•	•	•
	19 578 001	•	•	•	•	•	•	•	•	•	•
	19 967 001	•	•	•	•	•	•	•	•	•	•
	23 462 001	•	•	•	•	•	•	•	•	•	•
	23 491 001	•	•	•	•	•	•	•	•	•	•
	23 589 001	•	•	•	•	•	•	•	•	•	•
	32 628 001	•	•	•	•	•	•	•	•	•	•
	32 901 001	•	•	•	•	•	•	•	•	•	•
	32 935 001	•	•	•	•	•	•	•	•	•	•
	33 624 001	•	•	•	•	•	•	•	•	•	•
	33 636 001	•	•	•	•	•	•	•	•	•	•
	GRANDERA	19 920 000	•				•				
19 936 000		•		•		•		•	•		
19 937 000		•				•					
20 389 000		•		•		•		•	•		
23 303 000		•		•		•		•	•		
23 318 000		•		•		•		•	•		
40 625 000		•				•					
40 629 000		•				•					
40 630 000		•				•					
40 631 000		•		•	•	•	•	•	•	•	•
ALLURE BRILLIANT	19 785 000	•				•		•			
	19 792 000	•		•	•	•	•	•	•	•	•
	20 344 000	•		•		•		•			
	23 029 000	•		•	•	•	•	•	•	•	•
	23 119 000	•				•		•			
ESSENTIALS	40 364 001	•	•	•	•	•	•	•	•	•	•
	40 365 001	•	•	•	•	•	•	•	•	•	•
	40 366 001	•	•	•	•	•	•	•	•	•	•
	40 367 001	•	•	•	•	•	•	•	•	•	•
	40 369 001	•	•	•	•	•	•	•	•	•	•
	40 371 001	•	•	•	•	•	•	•	•	•	•
	40 374 001	•	•	•	•	•	•	•	•	•	•
	40 385 001	•	•	•	•	•	•	•	•	•	•
	40 386 001	•	•	•	•	•	•	•	•	•	•
	40 394 001	•	•	•	•	•	•	•	•	•	•
	40 421 001	•	•	•	•	•	•	•	•	•	•
	40 688 001	•	•	•	•	•	•	•	•	•	•
	40 689 001	•	•	•	•	•	•	•	•	•	•
	40 800 001	•	•	•	•	•	•	•	•	•	•
	40 802 001	•	•	•	•	•	•	•	•	•	•
SHOWERS	19 468 000	•	•	•	•	•	•	•	•	•	•
	26 066 000	•	•	•	•	•	•	•	•	•	•
	26 067 000	•	•	•	•	•	•	•	•	•	•
	26 075 000	•	•	•	•	•	•	•	•	•	•
	27 226 001	•	•	•	•	•	•	•	•	•	•
	27 251 000	•		•	•	•	•	•	•	•	•
	27 271 000	•		•	•	•	•	•	•	•	•
	27 477 000	•		•		•		•	•		
	27 491 000	•		•		•		•	•		
	34 065 002	•	•	•	•	•	•	•	•	•	•

Replace the second and third last digit and replace by the below colour code to order the coloured version.

- Colour options:
- 00 | StarLight Chrome
 - DC | SuperSteel
 - GL | Cool Sunrise
 - GN | Brushed Cool Sunrise
 - DA | Warm Sunset
 - DL | Brushed Warm Sunset
 - A0 | Hard Graphite
 - AL | Brushed Hard Graphite
 - BE | Polished Nickel
 - EN | Brushed Nickel

This is only a selection of the product range. All other products from the range are also available in SPA Colours by special production.



DISCOVER THE WORLD OF GROHE

What you see here represents just a small selection of what the world of GROHE has to offer. Whether you are looking for ideas and inspiration or solutions for bath and kitchen, here's where you'll find it.

Just scan the QR codes to view the latest brochures as download or PDF on your tablet or smart phone.

Or visit the world of GROHE at grohe.com



SPA Broschure



GROHE Magazine



Water.Intelligence.Enjoyment. Magazine

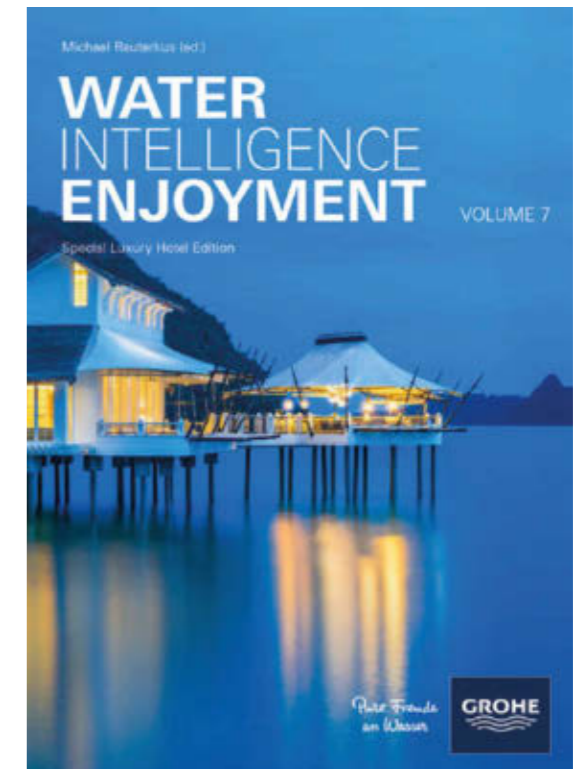

Water Intelligence Enjoyment Book

GROHE.COM

Follow us



Just scan the QR code to view the latest brochure as download or PDF on your tablet or smartphone.

Grohe AG
Feldmühleplatz 15
D - 40545 Düsseldorf
Germany

© 08/2017 – Copyright by GROHE

PART OF LIXIL