

Contemporary Lines

Purezze minimaliste, virtuosismi scultorei, geometrismi architettonici...Un panorama progettuale ricco di suggestioni, armonie, contrasti, giochi di forme, texture e colori. È il catalogo design di CRISTINA, nato dal connubio tra il know-how creativo e tecnico dell'azienda e il talento delle grandi firme del progetto. Per un ambiente squisitamente contemporaneo.

Minimalistische Reinheit, bildhauerische Virtuosität, architektonische Geometrien... Ein reizvoller, harmonievoller und kontrastreicher Projektaufbau, der sich durch Form- und Farbspiele auszeichnet. Der Designkatalog von CRISTINA entsteht aus der Vereinigung von kreativen un technischen Knowhow mit dem Talent der bedeutenden Namen, die an diesem Projekt beteiligt sind. Für ein herrlich zeitgenössisches Ambiente.

Minimalist purity, sculptural virtuosity, architectural geometries... A design landscape full of charm, harmonies, contrasts, playful forms, textures and colours. That's the CRISTINA catalogue, born from the combination of the creative and technical know-how of the company and the talent of the best designers. For an exquisitely contemporary environment.

Pureté minimaliste, sculpture de maître, géométries architecturales... Un projet à l'italienne riche en suggestions, contrastes, jeux de formes, textures et couleurs. Le catalogue design de CRISTINA est né du mariage entre savoir-faire créatif et technique de l'entreprise et le talent des grands noms du project. Pour un environnement délicieusement contemporain.

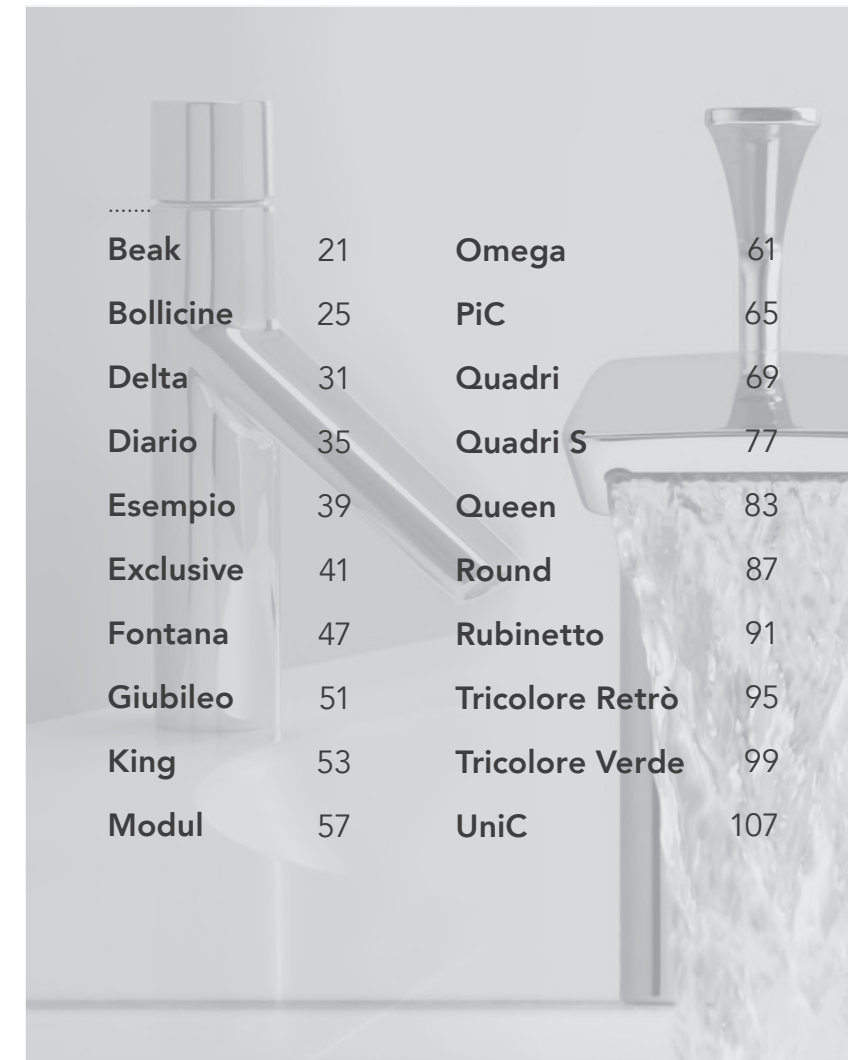

.....			
Beak	21	Omega	61
Bollicine	25	PiC	65
Delta	31	Quadri	69
Diario	35	Quadri S	77
Esempio	39	Queen	83
Exclusive	41	Round	87
Fontana	47	Rubinetto	91
Giubileo	51	Tricolore Retrò	95
King	53	Tricolore Verde	99
Modul	57	UniC	107



LAVABO / BASIN WASCHTISCH / LAVABO

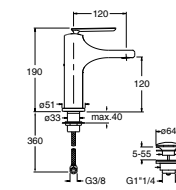

BE 220 REGULAR

Miscelatore monocomando
REGULAR per lavabo con
scarico Up&Down da 1"1/4

Waschtisch -Einhandmischer
REGULAR mit Ablaufgarnitur
Up&Down 1"1/4

Basin mixer REGULAR
with 1"1/4 Up&Down
waste

Mitigeur lavabo REGULAR
avec vidage Up&Down 1"1/4

BE 920 Senza scarico · Without waste · Ohne Ablaufgarnitur · Sans vidage

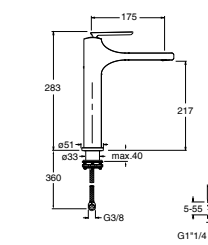

BE 222 TALL

Miscelatore monocomando
TALL per lavabo con
scarico Up&Down da 1"1/4

Waschtisch -Einhandmischer
TALL mit Ablaufgarnitur
Up&Down 1"1/4

Basin mixer TALL
with 1"1/4 Up&Down
waste

Mitigeur lavabo TALL
avec vidage Up&Down 1"1/4

BE 922 Senza scarico · Without waste · Ohne Ablaufgarnitur · Sans vidage

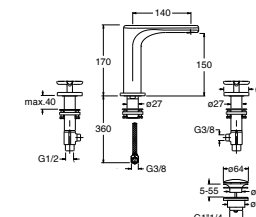

BE 205 REGULAR

Miscelatore bicomando
REGULAR per lavabo 3 fori con
scarico Up&Down da 1"1/4

3-Loch Waschtischbatterie
REGULAR mit Ablaufgarnitur
Up&Down 1"1/4

3 hole basin mixer
REGULAR with 1"1/4
Up&Down waste

Mélangeur lavabo 3 trous REGULAR
avec vidage Up&Down 1"1/4

BE 905 Senza scarico · Without waste · Ohne Ablaufgarnitur · Sans vidage

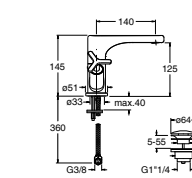

BE 226 REGULAR

Miscelatore bicomando
REGULAR per lavabo con
scarico Up&Down da 1"1/4

Zweigriff-Waschtischbatterie
REGULAR mit Ablaufgarnitur
Up&Down 1"1/4

Basin mixer
REGULAR with 1"1/4
Up&Down waste

Mélangeur lavabo REGULAR
avec vidage Up&Down 1"1/4

BE 926 Senza scarico · Without waste · Ohne Ablaufgarnitur · Sans vidage

LAVABO / BASIN
WASCHTISCH / LAVABO

Beak

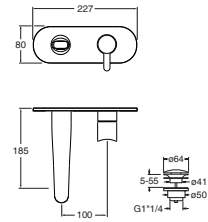

BE 276 REGULAR

Set da esterno per miscelatore monocomando lavabo REGULAR CS 237-CS 238 con scarico Up&Down da 1"1/4 e piastra in metallo

Fertigmontageset Waschtisch-Einhandmischer REGULAR Wandmontage für Einbaukörper CS 237 - CS 238 mit Ablaufgarnitur Up&Down 1"1/4 und Abdeckplatte aus Metall

BE 976 Senza scarico · Without waste · Ohne Ablaufgarnitur · Sans vidage

Wall mounted basin mixer REGULAR external parts for CS 237 - CS 238 with 1"1/4 Up&Down waste and metal plate

Façade externe mitigeur lavabo encastré REGULAR pour CS 237 - CS 238 avec vidage Up&Down 1"1/4 et plaque en métal

BE 242 REGULAR

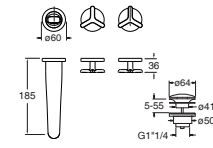

Set da esterno miscelatore bicomando lavabo REGULAR per CS 233 - CS 234 con scarico Up&Down da 1"1/4

Fertigmontageset Zweigriff-Waschtischbatterie REGULAR Wandmontage für Einbaukörper CS 233 - CS 234 mit Ablaufgarnitur Up&Down 1"1/4

BE 942 Senza scarico · Without waste · Ohne Ablaufgarnitur · Sans vidage

Wall mounted basin mixer REGULAR external parts for CS 233 - CS 234 with 1"1/4 Up&Down waste

Façade externe mélangeur lavabo encastré REGULAR pour mécanisme CS 233 - CS 234 avec vidage Up&Down 1"1/4

BIDET / BIDET

Beak

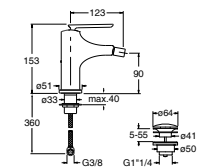

BE 320

Miscelatore monocomando per bidet con scarico Up&Down da 1"1/4

Bidet-Einhandmischer mit Ablaufgarnitur Up&Down 1"1/4

BE 370 Senza scarico · Without waste · Ohne Ablaufgarnitur · Sans vidage

Bidet mixer with 1"1/4 Up&Down waste

Mitigeur bidet avec vidage Up&Down 1"1/4

BE 326

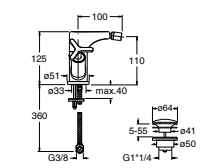

Miscelatore bicomando per bidet con scarico da Up&Down da 1"1/4

Zweigriff-Bidetbatterie mit Ablaufgarnitur Up&Down 1"1/4

BE 376 Senza scarico · Without waste · Ohne Ablaufgarnitur · Sans vidage

Bidet mixer with 1"1/4 Up&Down waste

Mélangeur bidet avec vidage Up&Down 1"1/4

VASCA / BATH
WANNEN / BAIN DOUCHE

Beak

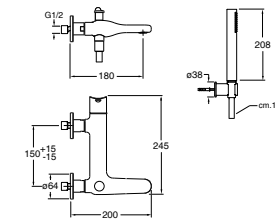

BE 180

Miscelatore monocomando per vasca esterno con flessibile LONG LIFE e doccetta anticalcare

Wannen-Einhandmischer Aufputz mit Brauseschlauch LONG LIFE und Handbrause mit Antikalk-System

External bath mixer with LONG LIFE flexible hose and anti-lime hand shower

Mitigeur bain douche extérieur avec flexible LONG LIFE et douchette anticalcaire

BE 108

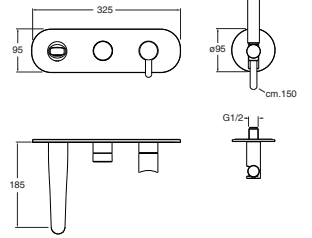

Set da esterno per miscelatore monocomando doccia/vasca CS 137 con deviatore 2 uscite, doccetta anticalcare in ottone, flessibile LONG LIFE e piastra in metallo

Fertigmontageset Brause / Wannen-Einhandmischer mit 2 Wege Umsteller für Einbaukörper CS 137, Handbrause aus Messing mit Antikalk-System, Brauseschlauch LONG LIFE und Abdeckplatte aus Metall

Bath/shower mixer external parts for CS 137 with 2 outlet diverter LONG LIFE flexible hose, brass anti-lime hand shower and metal plate

Façade externe mitigeur douche/bain douche encastré pour mécanisme CS137 avec inverseur 2 sorties, douchette anticalcaire en laiton, flexible LONG LIFE et plaque en métal

DOCCIA / SHOWER
BRAUSE / DOUCHE

Beak

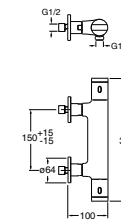

BE 451

Miscelatore termostatico per doccia esterno

Termostat-Brausebatterie Aufputz

External thermostatic shower mixer

Mitigeur douche thermostatique extérieur

BE 689

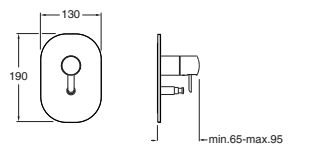

Set da esterno per miscelatore monocomando doccia/vasca CS 535 con deviatore 2 uscite e piastra in metallo

Fertigmontageset Wannen/Brause-Einhandmischer für Einbaukörper CS 535 mit 2 Wege Umsteller und Abdeckplatte aus Metall

Bath/shower mixer external parts for CS 535 with 2 outlet diverter and metal plate

Façade externe pour mitigeur douche/bain douche 2 sorties pour mécanisme CS 535 avec plaque en métal



BO 220

LAVABO / BASIN
WASCHTISCH / LAVABO

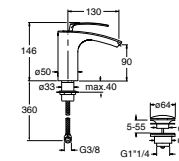

BO 220 REGULAR

Miscelatore monocomando per lavabo REGULAR con scarico Up&Down da 1"1/4

Waschtisch-Einhandmischer REGULAR mit Ablaufgarnitur Up&Down 1"1/4

Basin mixer REGULAR with 1"1/4 Up&Down waste

Mitigeur lavabo REGULAR avec vidage Up&Down 1"1/4

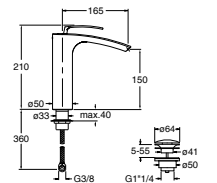

BO 227 MEDIUM

Miscelatore monocomando per lavabo MEDIUM con scarico Up&Down da 1"1/4

Waschtisch-Einhandmischer MEDIUM mit Ablaufgarnitur Up&Down 1"1/4

Basin mixer MEDIUM with 1"1/4 Up&Down waste

Mitigeur lavabo MEDIUM avec vidage Up&Down 1"1/4

BO 920 Senza scarico · Without waste · Ohne Ablaufgarnitur · Sans vidage

BO 927 Senza scarico · Without waste · Ohne Ablaufgarnitur · Sans vidage

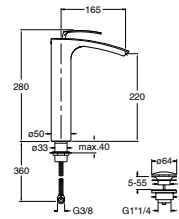

BO 228 TALL

Miscelatore monocomando TALL per lavabo con scarico Up&Down da 1"1/4

Waschtisch-Einhandmischer TALL mit Ablaufgarnitur Up&Down 1"1/4

Basin mixer TALL with 1"1/4 Up&Down waste

Mitigeur lavabo TALL avec vidage Up&Down 1"1/4

BO 928 Senza scarico · Without waste · Ohne Ablaufgarnitur · Sans vidage

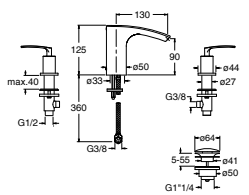

BO 205 REGULAR

Miscelatore bicomando REGULAR per lavabo 3 fori con scarico Up&Down da 1"1/4

3-Loch Waschtischbatterie REGULAR mit Ablaufgarnitur Up&Down 1"1/4

3 hole basin mixer REGULAR with 1"1/4 Up&Down waste

Mélangeur lavabo 3 trous REGULAR avec vidage Up&Down 1"1/4

BO 905 Senza scarico · Without waste · Ohne Ablaufgarnitur · Sans vidage

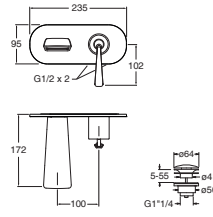
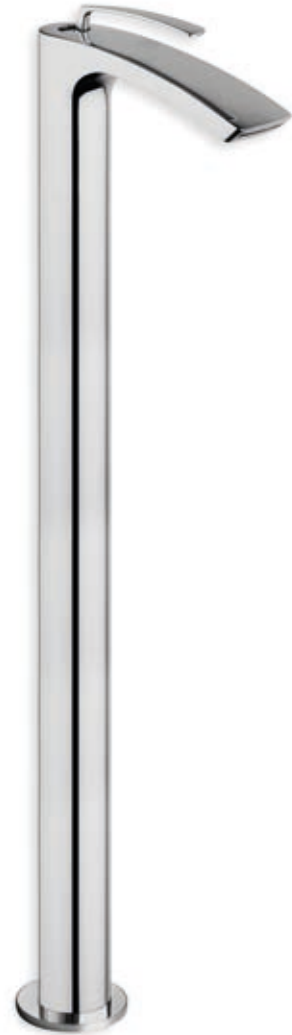

BO 266 REGULAR

Set da esterno per miscelatore monocomando lavabo REGULAR CS 237 - CS 238 con scarico Up&Down da 1"1/4 e piastra in metallo

Fertigmontageset Waschtisch-Einhandmischer REGULAR Wandmontage für Einbaukörper CS 237 - CS 238 mit Ablaufgarnitur Up&Down 1"1/4 und Abdeckplatte aus Metall

Wall mounted basin mixer REGULAR external parts for CS 237 - CS 238 with 1"1/4 Up&Down waste and metal plate

Façade externe mitigeur lavabo encastré REGULAR pour mécanisme CS 237 - CS 238 avec vidage Up&Down 1"1/4 et plaque en métal

BO 966 Senza scarico · Without waste · Ohne Ablaufgarnitur · Sans vidage

BO 290

Set da esterno per miscelatore monocomando lavabo a pavimento CS 290 con scarico Up&Down da 1"1/4

Fertigmontageset Waschtisch-Einhandmischer bodenstehend für Einbaukörper CS 290 mit Ablaufgarnitur Up&Down 1"1/4

Floor mounted basin mixer external parts for CS 290 with 1"1/4 Up&Down waste

Façade externe mitigeur lavabo sur pied pour mécanisme CS 290 avec vidage Up&Down 1"1/4

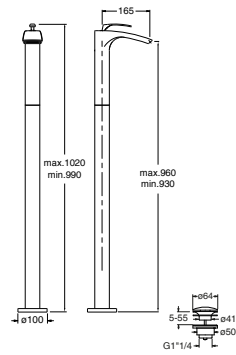

BO 242 REGULAR

Set da esterno miscelatore bicomando lavabo REGULAR per CS 233 con scarico Up&Down da 1"1/4 e piastra in metallo

Fertigmontageset Zweigriff-Waschtischbatterie REGULAR Wandmontage für Einbaukörper CS 233 mit Ablaufgarnitur Up&Down 1"1/4 und Abdeckplatte aus Metall

Wall mounted basin mixer REGULAR external parts for CS 233 with 1"1/4 Up&Down waste and metal plate

Façade externe mélangeur lavabo encastré REGULAR pour mécanisme CS 233 avec vidage Up&Down 1"1/4 et plaque en métal

BO 942 Senza scarico · Without waste · Ohne Ablaufgarnitur · Sans vidage

BO 990 Senza scarico · Without waste · Ohne Ablaufgarnitur · Sans vidage

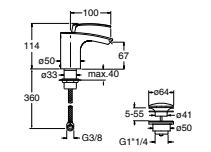

BO 320

Miscelatore monocomando per bidet con scarico Up&Down da 1"1/4

Bidet-Einhandmischer mit Ablaufgarnitur Up&Down 1"1/4

Bidet mixer with 1"1/4 Up&Down waste

Mitigeur bidet avec vidage Up&Down 1"1/4

BO 370 Senza scarico · Without waste · Ohne Ablaufgarnitur · Sans vidage

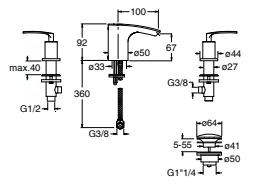

BO 330

Miscelatore bicomando per bidet 3 fori con scarico Up&Down da 1"1/4

3-Loch Bidetbatterie mit Ablaufgarnitur Up&Down 1"1/4

3 hole bidet mixer with 1"1/4 Up&Down waste

Mélangeur bidet 3 trous avec vidage Up&Down 1"1/4

BO 380 Senza scarico · Without waste · Ohne Ablaufgarnitur · Sans vidage

VASCA / BATH
WANNEN / BAIN DOUCHE

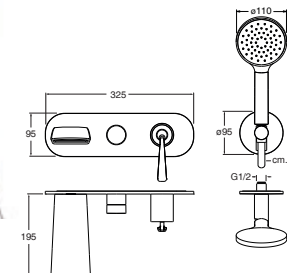

BO 108

Set da esterno per miscelatore monocomando doccia/vasca CS 137 con deviatore 2 uscite, doccetta anticalcare, flessibile LONG LIFE e piastra in metallo

Fertigmontageset Brause/Wannen-Einhandmischer für Einbaukörper CS 137 mit 2 Wege Umsteller, Handbrause mit Antikalk-System, Brauseschlauch LONG LIFE und Abdeckplatte aus Metall

Bath/shower mixer external parts for CS 137 with 2 outlet diverter, anti-lime hand shower, LONG LIFE flexible hose and metal plate

Façade externe mitigeur douche/bain douche encastré pour mécanisme CS 137 avec inverseur 2 sorties, douchette anticalcaire, flexible LONG LIFE et plaque en métal

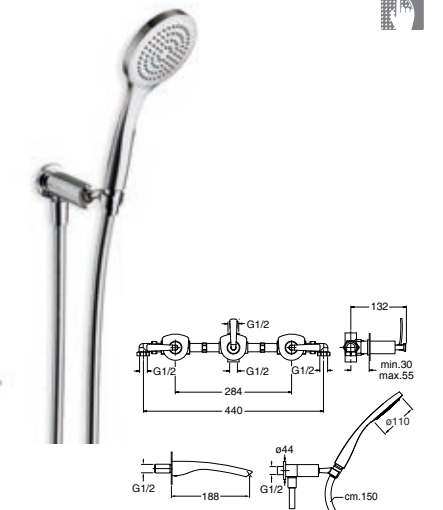

BO 111

Set completo per miscelatore bicomando vasca da incasso con bocca erogazione, flessibile LONG LIFE e doccetta anticalcare orientabile

Unterputz 3-Loch Wannenbatterie inkl. Einbaukörper mit Wanneneinlauf, Brauseschlauch LONG LIFE, Handbrause mit Antikalk-System und verstellbarem Wandhalter

Complete 3 hole concealed bath mixer with spout, LONG LIFE flexible hose and adjustable anti-lime hand shower

Mélangeur douche/bain douche encastré complet avec bec de remplissage, flexible LONG LIFE et douchette anticalcaire orientable

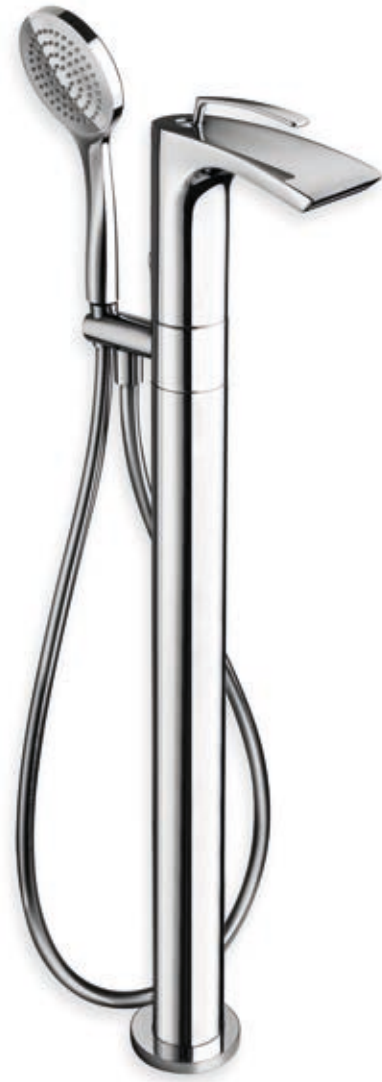

BO 190

Set da esterno per miscelatore monocomando vasca a pavimento CS 290 con flessibile LONG LIFE e doccetta anticalcare

Fertigmontageset Wannen-Einhandmischer bodenstehend für Einbaukörper CS 290 mit Brauseschlauch LONG LIFE und Handbrause mit Antikalk-System

Floor mounted bath mixer external parts for CS 290 with LONG LIFE flexible hose and anti-lime hand shower

Façade externe mitigeur bain douche sur pied pour mécanisme CS 290 avec flexible LONG LIFE et douchette anticalcaire

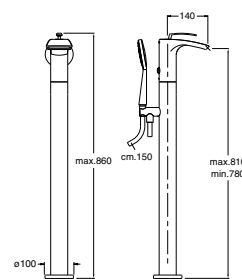

BO 121

Miscelatore monocomando per bordo vasca 2 fori con deviatore, doccetta anticalcare estraibile e FOLLOW ME

2-Loch Wannenrand-Einhandmischer mit Umsteller, herausziehbarer Handbrause mit Antikalk-System und FOLLOW ME - Funktion

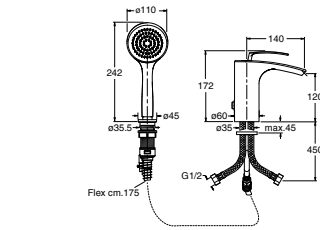

2 hole deck mounted bath mixer with diverter, pull-out anti-lime hand shower and FOLLOW ME

Mitigeur bain douche sur gorge 2 trous avec inverseur, douchette anticalcaire extractible et FOLLOW ME



BO 126

Miscelatore bicomando per bordo vasca 4 fori con deviatore, bocca erogazione, doccetta anticalcare estraibile e FOLLOW ME

4-Loch Wannenrandkombination mit Umsteller, Wanneneinlauf, herausziehbarer Handbrause mit Antikalk-System und FOLLOW ME - Funktion

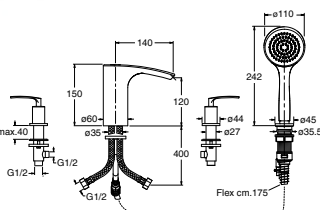

4 hole deck mounted bath mixer with diverter, spout, pull-out anti-lime hand shower and FOLLOW ME

Mélangeur bain douche sur gorge 4 trous avec inverseur, bec de remplissage, douchette anticalcaire extractible et FOLLOW ME



BO 689

Set da esterno per miscelatore monocomando doccia/vasca CS 535 con deviatore 2 uscite e piastra in metallo

Fertigmontageset Wannen/Brause-Einhandmischer für Einbaukörper CS 535 mit 2 Wege Umsteller und Abdeckplatte aus Metall

Bath/shower mixer external parts for CS 535 with 2 outlet diverter and metal plate

Façade externe pour mitigeur douche/bain douche 2 sorties pour mécanisme CS 535 avec plaque en métal

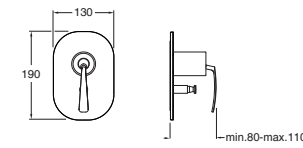

BO 113

Set completo per miscelatore bicomando vasca da incasso con bocca erogazione, soffione anticalcare ispezionabile, flessibile LONG LIFE e doccetta anticalcare

Unterputz 3-Loch Wannenbatterie inkl. Einbaukörper mit Wanneneinlauf, Kopfbrause mit Antikalk-System, Brauseschlauch LONG LIFE und Handbrause mit Antikalk-System

Complete 3 hole concealed bath mixer with spout, checkable anti-lime overhead shower, LONG LIFE flexible hose and anti-lime hand shower

Mélangeur douche/bain douche encastré complet avec bec de remplissage, pomme de douche anticalcaire démontable, flexible LONG LIFE et douchette anticalcaire

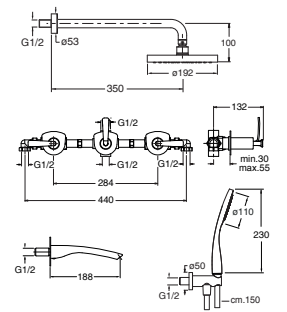



LAVABO / BASIN
WASCHTISCH / LAVABO

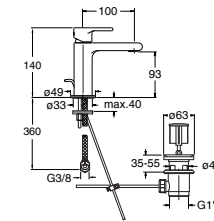

DE 221 REGULAR

Miscelatore monocomando REGULAR per lavabo con scarico 1"1/4 e asta comando

Basin mixer REGULAR with 1"1/4 pop up waste

Waschtisch-Einhandmischer REGULAR mit Ablaufgarnitur 1"1/4 und Zugstange

Mitigeur lavabo REGULAR avec vidage 1"1/4 à trette

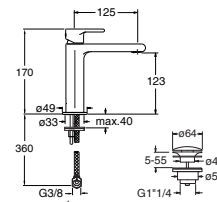

DE 227 MEDIUM

Miscelatore monocomando MEDIUM per lavabo con scarico Up&Down da 1"1/4

Basin mixer MEDIUM with 1"1/4 Up&Down waste

Waschtisch-Einhandmischer MEDIUM mit Ablaufgarnitur Up&Down 1"1/4

Mitigeur lavabo MEDIUM avec vidage Up&Down 1"1/4

DE 920 Senza scarico · Without waste · Ohne Ablaufgarnitur · Sans vidage

DE 927 Senza scarico · Without waste · Ohne Ablaufgarnitur · Sans vidage

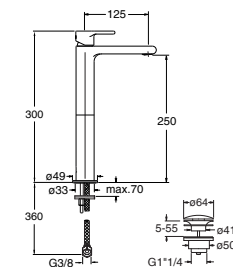

DE 222 TALL

Miscelatore monocomando TALL per lavabo con scarico Up&Down da 1"1/4

Basin mixer TALL with 1"1/4 Up&Down waste

Waschtisch-Einhandmischer TALL mit Ablaufgarnitur Up&Down 1"1/4

Mitigeur lavabo TALL avec vidage Up&Down 1"1/4

DE 922 Senza scarico · Without waste · Ohne Ablaufgarnitur · Sans vidage

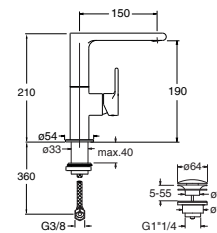

DE 228 REGULAR

Miscelatore monocomando REGULAR per lavabo con bocca girevole e scarico Up&Down da 1"1/4

Basin mixer REGULAR with swivel spout and 1"1/4 Up&Down waste

Waschtisch-Einhandmischer REGULAR mit schwenkbarem Auslauf und Ablaufgarnitur Up&Down 1"1/4

Mitigeur lavabo REGULAR avec bec orientable et vidage Up&Down 1"1/4

DE 928 Senza scarico · Without waste · Ohne Ablaufgarnitur · Sans vidage

LAVABO / BASIN
WASCHTISCH / LAVABO

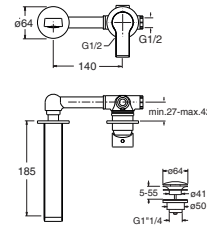

DE 237 REGULAR

Set completo per miscelatore monocomando lavabo REGULAR da incasso con scarico Up&Down da 1"1/4

Unterputz-Waschtisch-Einhandmischer REGULAR Wandmontage inkl. Einbaukörper mit Ablaufgarnitur Up&Down 1"1/4

Complete wall mounted basin mixer REGULAR with 1"1/4 Up&Down waste

Mitigeur lavabo encastré REGULAR complet avec vidage Up&Down 1"1/4

DE 937 Senza scarico · Without waste · Ohne Ablaufgarnitur · Sans vidage

VASCA / BATH
WANNEN / BAIN DOUCHE

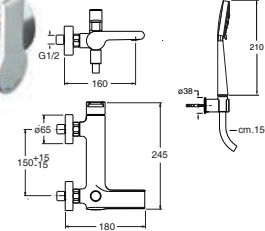

DE 180

Miscelatore monocomando per vasca esterno con flessibile LONG LIFE e doccetta comfort anticalcare

Wannen-Einhandmischer Aufputz mit Brauseschlauch LONG LIFE und Komfort Handbrause mit Antikalk-System

External bath mixer with LONG LIFE flexible hose and anti-lime comfort hand shower

Mitigeur bain douche extérieur avec flexible LONG LIFE et douchette anticalcaire confort

BIDET / BIDET

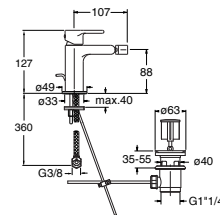

DE 321

Miscelatore monocomando per bidet con scarico 1"1/4 e asta comando

Bidet-Einhandmischer mit Ablaufgarnitur 1"1/4 und Zugstange

Bidet mixer with 1"1/4 pop up waste

Mitigeur bidet avec vidage 1"1/4 à tirette

DE 370 Senza scarico · Without waste · Ohne Ablaufgarnitur · Sans vidage

Delta



VASCA / BATH
WANNEN / BAIN DOUCHE

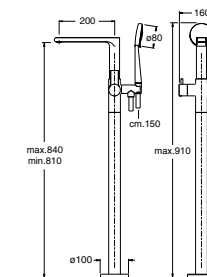
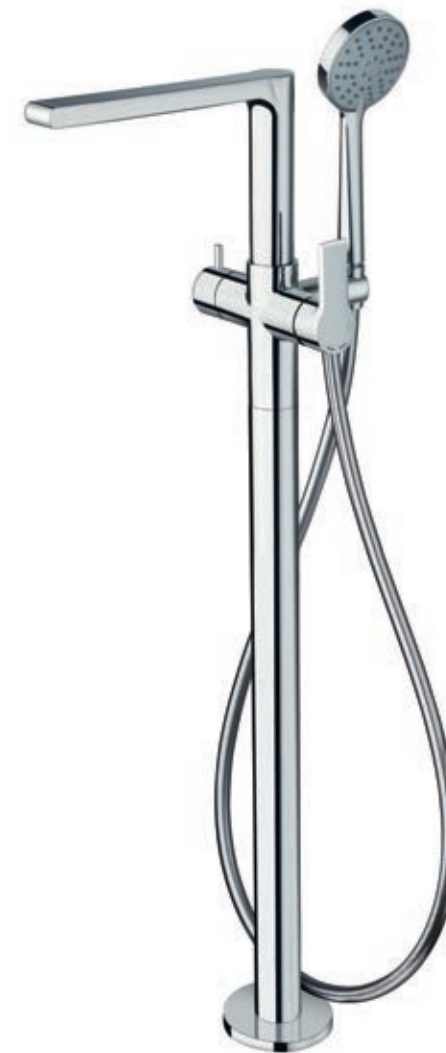

DE 189

Set da esterno per miscelatore monocomando vasca a pavimento CS 290 con flessibile LONG LIFE e doccetta anticalcare con miscelazione indipendente

Fertigmontageset Wannen-Einhandmischer bodenstehend für Einbaukörper CS 290 mit Brauseschlauch LONG LIFE und Handbrause mit Antikalk-System und separater Mischung

Floor mounted bath mixer external parts for CS 290 with LONG LIFE flexible hose and anti-lime hand shower with independent mixing

Façade externe mitigeur bain douche sur pied pour mécanisme CS 290 avec flexible LONG LIFE et douchette anticalcaire avec mélange indépendant

DOCCIA / SHOWER
BRAUSE / DOUCHE

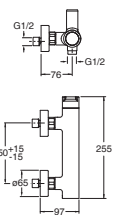

DE 481

Miscelatore monocomando per doccia esterno

Brause-Einhandmischer Aufputz

External shower mixer

Mitigeur douche extérieur

Delta





LAVABO / BASIN WASCHTISCH / LAVABO

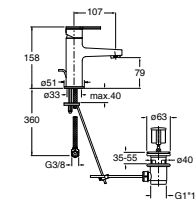

DI 221 REGULAR

Miscelatore monocomando REGULAR per lavabo con scarico 1"1/4 e asta comando

Basin mixer REGULAR with 1"1/4 pop up waste

Waschtisch-Einhandmischer REGULAR mit Ablaufgarnitur 1"1/4 und Zugstange

Mitigeur lavabo REGULAR avec vidage 1"1/4 à trette

DI 920 Senza scarico · Without waste · Ohne Ablaufgarnitur · Sans vidage

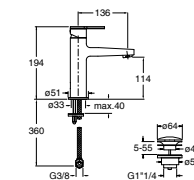

DI 263 MEDIUM

Miscelatore monocomando MEDIUM per lavabo con scarico Up&Down da 1"1/4

Basin mixer MEDIUM with 1"1/4 Up&Down waste

Waschtisch-Einhandmischer MEDIUM mit Ablaufgarnitur Up&Down 1"1/4

Mitigeur lavabo MEDIUM avec vidage Up&Down 1"1/4

DI 963 Senza scarico · Without waste · Ohne Ablaufgarnitur · Sans vidage

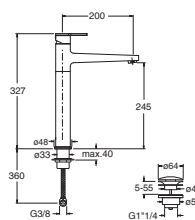

DI 222 TALL

Miscelatore monocomando TALL per lavabo con scarico Up&Down da 1"1/4

Basin mixer TALL with 1"1/4 Up&Down waste

Waschtisch-Einhandmischer TALL mit Ablaufgarnitur Up&Down 1"1/4

Mitigeur lavabo TALL avec vidage Up&Down 1"1/4

DI 922 Senza scarico · Without waste · Ohne Ablaufgarnitur · Sans vidage

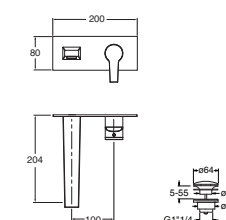

DI 266 REGULAR

Set da esterno per miscelatore monocomando lavabo REGULAR CS 237 - CS 238 con scarico Up&Down da 1"1/4 e piastra in metallo

Wall mounted basin mixer REGULAR external parts for CS 237 - CS 238 with 1"1/4 Up&Down waste and metal plate

Fertigmontageset Waschtisch-Einhandmischer REGULAR Wandmontage für Einbaukörper CS 237 - CS 238 mit Ablaufgarnitur Up&Down 1"1/4 und Abdeckplatte aus Metall

Façade externe mitigeur lavabo encastré REGULAR pour mécanisme CS 237 - CS 238 avec vidage Up&Down 1"1/4 et plaque en métal

DI 966 Senza scarico · Without waste · Ohne Ablaufgarnitur · Sans vidage

BIDET / BIDET



DI 321

Miscelatore monocomando per bidet con scarico 1"1/4 e asta comando

Bidet mixer with 1"1/4 pop up waste

Bidet-Einhandmischer mit Ablaufgarnitur 1"1/4 und Zugstange

Mitigeur bidet avec vidage 1"1/4 à tirette

DI 370 Senza scarico · Without waste · Ohne Ablaufgarnitur · Sans vidage

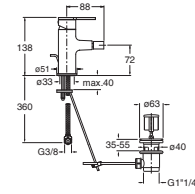

VASCA / BATH
WANNEN / BAIN DOUCHE



DI 100

Miscelatore monocomando per vasca esterno con flessibile LONG LIFE e doccetta anticalcare

External bath mixer with LONG LIFE flexible hose and anti-lime hand shower

Wannen-Einhandmischer Aufputz mit Braueschlauch LONG LIFE und Handbrause mit Antikalk-System

Mitigeur bain douche extérieur avec flexible LONG LIFE et douchette anticalcaire

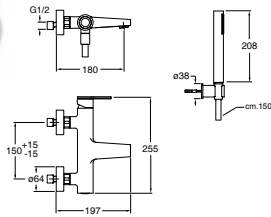

DOCCIA / SHOWER
BRAUSE / DOUCHE

Diario



DI 401

Miscelatore monocomando per doccia esterno

External shower mixer

Brause-Einhandmischer Aufputz

Mitigeur douche extérieur

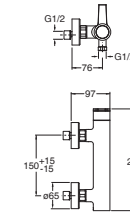

VASCA / BATH
WANNEN / BAIN DOUCHE



DI 108

Set da esterno per miscelatore monocomando doccia/vasca CS 137 con deviatore 2 uscite, doccetta anticalcare, flessibile LONG LIFE e piastra in metallo

Bath/shower mixer external parts for CS 137 with 2 outlet diverter, anti-lime hand shower, LONG LIFE flexible hose and metal plate

Fertigmontageset Brause/Wannen-Einhandmischer mit 2 Wege Umsteller für Einbaukörper CS 137, Handbrause mit Antikalk-System, Braueschlauch LONG LIFE und Abdeckplatte aus Metall

Façade externe mitigeur douche / bain douche encastré pour mécanisme CS 137 avec inverseur 2 sorties, douchette anticalcaire, flexible LONG LIFE et plaque en métal

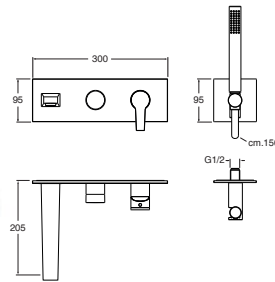

DI 129

Miscelatore monocomando per bordo vasca con deviatore 2 uscite e piastra in metallo

Deck mounted bath mixer with 2 outlet diverter and metal plate

Wannenrand-Einhandmischer mit 2 Wege Umsteller mit Abdeckplatte aus Metall

Mitigeur bain douche sur gorge avec inverseur 2 sorties et plaque en métal

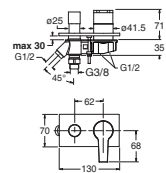

DI 689

Set da esterno per miscelatore monocomando doccia/vasca CS 535 con deviatore 2 uscite e piastra in metallo

Bath/shower mixer external parts for CS 535 with 2 outlet diverter and metal plate

Fertigmontageset Wannen/Brause-Einhandmischer für Einbaukörper CS 535 mit 2 Wege Umsteller und Abdeckplatte aus Metall

Façade externe pour mitigeur douche/bain douche 2 sorties pour mécanisme CS 535 avec plaque en métal

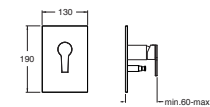

DI 486

Miscelatore termostatico per doccia esterno con colonna girevole, soffione anticalcare ispezionabile, doccetta anticalcare con supporto scorrevole e flessibile LONG LIFE

External thermostatic shower mixer with swivel column pipe, checkable anti-lime overhead shower, anti-lime hand shower with slide rail and LONG LIFE flexible hose

Termostat-Brausebatterie Aufputz mit schwenkbarem Rohr, Kopfbrause mit Antikalk-System, Braueschlauch LONG LIFE, Handbrause mit Antikalk-System und Gleitschieber

Colonne de douche orientable thermostatique avec pomme de douche anticalcaire démontable, douchette anticalcaire avec curseur réglable et flexible LONG LIFE

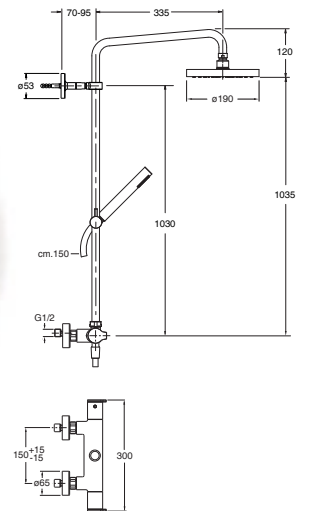



LAVABO / BASIN WASCHTISCH / LAVABO

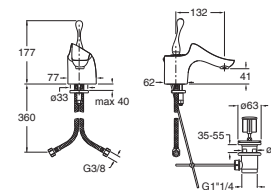

EP 221 REGULAR

Miscelatore monocomando REGULAR per lavabo con scarico 1"1/4 e asta comando

Waschtisch-Einhandmischer REGULAR mit Ablaufgarnitur 1"1/4 und Zugstange

Basin mixer REGULAR with 1"1/4 pop up waste

Mitigeur lavabo REGULAR avec vidage 1"1/4 à tirette

BIDET / BIDET

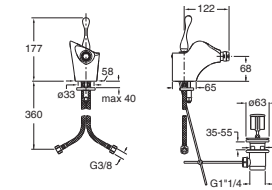

EP 321

Miscelatore monocomando per bidet con scarico 1"1/4 e asta comando

Bidet-Einhandmischer mit Ablaufgarnitur 1"1/4 und Zugstange

Bidet mixer with 1"1/4 pop up waste

Mitigeur bidet avec vidage 1"1/4 à tirette

VASCA / BATH WANNEN / BAIN DOUCHE

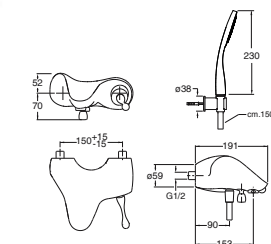

EP 100

Miscelatore monocomando per vasca esterno con flessibile LONG LIFE e doccia anticalcare

Wannen-Einhandmischer Aufputz mit Brauseschlauch LONG LIFE und Handbrause mit Antikalk-System

External bath mixer with LONG LIFE flexible hose and anti-lime hand shower

Mitigeur bain douche extérieur avec flexible LONG LIFE et douchette anticalcaire

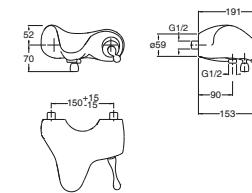

EP 107

Miscelatore monocomando per vasca esterno

Wannen-Einhandmischer Aufputz

External bath mixer

Mitigeur bain douche extérieur



EV226

LAVABO / BASIN
WASCHTISCH / LAVABO

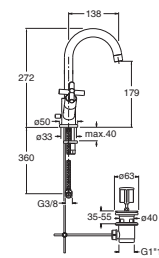

EV 226 REGULAR

Miscelatore bicomando REGULAR per lavabo con scarico 1"1/4 e asta comando

Zweigriff-Waschtischbatterie REGULAR mit Ablaufgarnitur 1"1/4 und Zugstange

Basin mixer REGULAR with 1"1/4 pop up waste

Mélangeur lavabo REGULAR avec vidage 1"1/4 à tirette

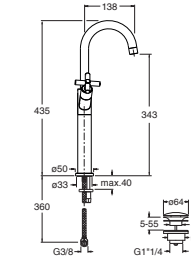

EV 248 TALL

Miscelatore bicomando TALL per lavabo con scarico Up&Down da 1"1/4

Zweigriff-Waschtischbatterie TALL mit Ablaufgarnitur Up&Down 1"1/4

Basin mixer TALL with 1"1/4 Up&Down waste

Mélangeur lavabo TALL avec vidage Up&Down 1"1/4

EV 948 Senza scarico · Without waste · Ohne Ablaufgarnitur · Sans vidage

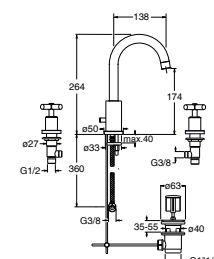
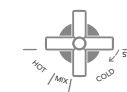

EV 205 REGULAR

Miscelatore bicomando REGULAR per lavabo 3 fori con scarico 1"1/4 e asta comando

3-Loch Waschtischbatterie REGULAR mit Ablaufgarnitur 1"1/4 und Zugstange

3 hole basin mixer REGULAR with 1"1/4 pop up waste

Mélangeur lavabo 3 trous REGULAR avec vidage 1"1/4 à tirette

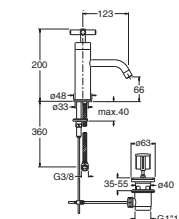

EV 221 REGULAR

Miscelatore monocomando progressivo REGULAR per lavabo con scarico 1"1/4 e asta comando

Waschtisch-Einhandmischer REGULAR mit progressiver Kartusche und Ablaufgarnitur 1"1/4 und Zugstange

Progressive basin mixer REGULAR with 1"1/4 pop up waste

Mitigeur lavabo REGULAR cartouche progressive avec vidage 1"1/4 à tirette

EV 920 Senza scarico · Without waste · Ohne Ablaufgarnitur · Sans vidage



LAVABO / BASIN
WASCHTISCH / LAVABO

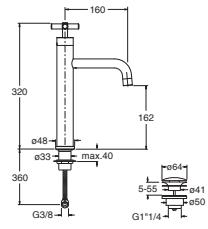

EV 225 MEDIUM

Miscelatore monocomando progressivo MEDIUM per lavabo con scarico Up&Down da 1"1/4

Waschtisch-Einhandmischer MEDIUM mit progressiver Kartusche und Ablaufgarnitur Up&Down 1"1/4

EV 925 Senza scarico · Without waste · Ohne Ablaufgarnitur · Sans vidage

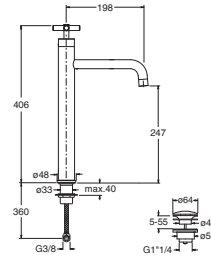

EV 222 TALL

Miscelatore monocomando progressivo TALL per lavabo con scarico Up&Down da 1"1/4

Waschtisch-Einhandmischer TALL mit progressiver Kartusche und Ablaufgarnitur Up&Down 1"1/4

EV 922 Senza scarico · Without waste · Ohne Ablaufgarnitur · Sans vidage

Exclusive



BIDET / BIDET

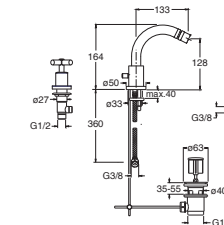
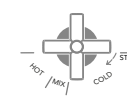

EV 330

Miscelatore bicomando per bidet 3 fori con scarico 1"1/4 e asta comando

3-Loch Bidetbatterie mit Ablaufgarnitur 1"1/4 und Zugstange

3 hole bidet mixer with 1"1/4 pop up waste

Mélangeur bidet 3 trous avec vidage 1"1/4 à tirette

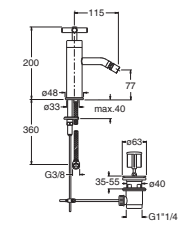

EV 321

Miscelatore monocomando progressivo per bidet con scarico 1"1/4 e asta comando

Bidet-Einhandmischer mit progressiver Kartusche und Ablaufgarnitur 1"1/4 und Zugstange

EV 370 Senza scarico · Without waste · Ohne Ablaufgarnitur · Sans vidage

Progressive bidet mixer with 1"1/4 pop up waste

Mitigeur bidet cartouche progressive avec vidage 1"1/4 à tirette

BIDET / BIDET

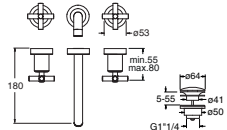

EV 242 REGULAR

Set da esterno miscelatore bicomando lavabo REGULAR per CS 233 - CS 234 con scarico Up&Down da 1"1/4

Fertigmontageset Zweigriff-Waschtischbatterie REGULAR Wandmontage für Einbaukörper CS 233 - CS 234 mit Ablaufgarnitur Up&Down 1"1/4

EV 942 Senza scarico · Without waste · Ohne Ablaufgarnitur · Sans vidage

Wall mounted basin mixer REGULAR external parts for CS 233 - CS 234 with 1"1/4 Up&Down waste

Façade externe mélangeur lavabo encastré REGULAR pour mécanisme CS 233 - CS 234 avec vidage Up&Down 1"1/4

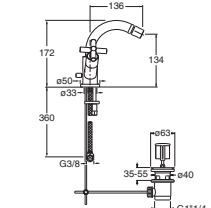

EV 326

Miscelatore bicomando per bidet con scarico 1"1/4 e asta comando

Zweigriff-Bidetbatterie mit Ablaufgarnitur 1"1/4 und Zugstange

EV 942 Senza scarico · Without waste · Ohne Ablaufgarnitur · Sans vidage

Bidet mixer with 1"1/4 pop up waste

Mélangeur bidet avec vidage 1"1/4 à tirette

VASCA / BATH
WANNEN / BAIN DOUCHE

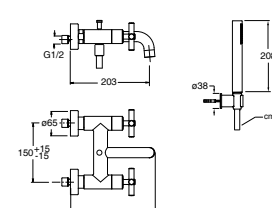

EV 180

Miscelatore bicomando per vasca esterno con flessibile LONG LIFE e doccia anticalcare

Zweigriff-Wannenbatterie Aufputz mit Brauseschlauch LONG LIFE und Handbrause mit Antikalk-System

External bath mixer with LONG LIFE flexible hose and anti-lime hand shower

Mélangeur bain douche avec flexible LONG LIFE et douche anticalcaire orientable

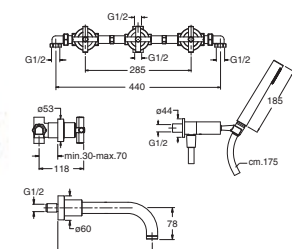

EV 111

Set completo per miscelatore bicomando vasca da incasso con bocca erogazione, flessibile LONG LIFE e doccia anticalcare orientabile

Unterputz 3-Loch Wannenbatterie inkl. Einbaukörper mit Wanneneinlauf, Brauseschlauch LONG LIFE, Handbrause mit Antikalk-System und verstellbarem Wandhalter

Complete 3 hole concealed bath mixer with spout, LONG LIFE flexible hose and adjustable anti-lime hand shower

Mélangeur douche/bain douche encastré complet avec bec de remplissage, flexible LONG LIFE et douche anticalcaire orientable

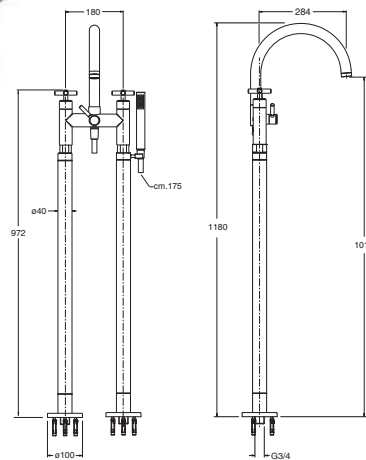

EV 108

Miscelatore bicomando per vasca esterno con colonne a pavimento, flessibile LONG LIFE e doccetta anticalcare

Zweigriff-Wannenbatterie Aufputz bodenstehend mit Brauseschlauch LONG LIFE und Handbrause mit Antikalk-System

Floor mounted bath mixer with LONG LIFE flexible hose and anti-lime hand shower

Mélangeur bain douche extérieur sur pied avec flexible LONG LIFE et douchette anticalcaire

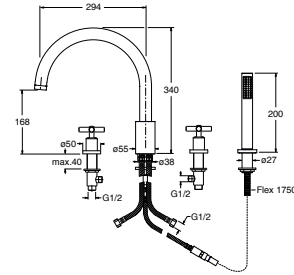

EV 124 LARGE

Miscelatore bicomando LARGE per bordo vasca 4 fori con bocca erogazione, doccetta anticalcare estraibile e deviatore

4-Loch Wannenrandkombination LARGE mit Umsteller, Wanneneinlauf und herausziehbarer Handbrause mit Antikalk-System

4 hole deck mounted bath mixer LARGE with diverter, spout and pull-out anti-lime hand shower

Mélangeur bain douche LARGE sur gorge 4 trous avec inverseur, bec de remplissage et douchette anticalcaire extractible

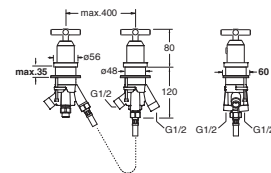

XV 142

Miscelatore termostatico per bordo vasca con deviatore 2 uscite

Thermostat Wannenrandbatterie mit 2 Wege Umsteller

Deck mounted thermostatic bath mixer with 2 outlet diverter

Mitigeur thermostatique bain douche sur gorge avec inverseur 2 sorties

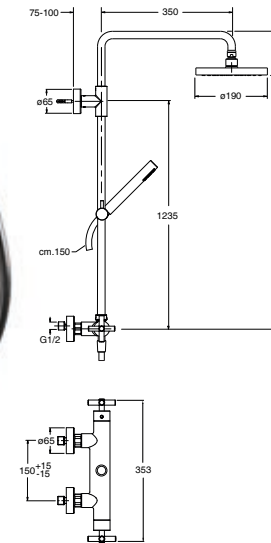

EV 456

Miscelatore termostatico per doccia esterno con colonna girevole, soffione anticalcare ispezionabile, doccetta anticalcare con supporto scorrevole e flessibile LONG LIFE

Thermostat-Brausebatterie Aufputz mit schwenkbarem Rohr, Kopfbrause mit Antikalk-System, Brauseschlauch LONG LIFE, Handbrause mit Antikalk-System und Gleitschieber

External thermostatic shower mixer with swivel column pipe, checkable anti-lime overhead shower, anti-lime hand shower with slide rail and LONG LIFE flexible hose

Colonne de douche orientable thermostatique avec pomme de douche anticalcaire démontable, douchette anticalcaire avec curseur réglable et flexible LONG LIFE

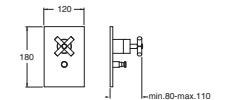

EV 669

Set da esterno per miscelatore monocomando progressivo doccia/vasca CS 535 con deviatore 2 uscite

Fertigmontageset Wannen/Brause-Einhandmischer mit progressiver Kartusche für Einbaukörper CS 535 mit 2 Wege Umsteller und Abdeckplatte aus ABS

Progressive bath/shower mixer external parts for CS 535 with 2 outlet diverter

Façade externe pour mitigeur douche/bain douche cartouche progressive 2 sorties pour mécanisme CS 535 et plaque en ABS



Ausführung für den deutschen Markt



LAVABO / BASIN
WASCHTISCH / LAVABO

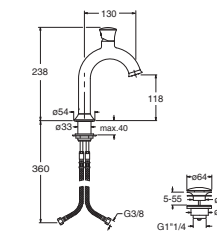

FN 220 REGULAR

Miscelatore monocomando
REGULAR per lavabo con scarico
Up&Down da 1"1/4

Waschtisch-Einhandmischer
REGULAR mit Ablaufgarnitur
Up&Down 1"1/4

Basin mixer REGULAR with 1"1/4
Up&Down waste

Mitigeur lavabo REGULAR
avec vidage Up&Down 1"1/4

FN 920 Senza scarico · Without waste · Ohne Ablaufgarnitur · Sans vidage

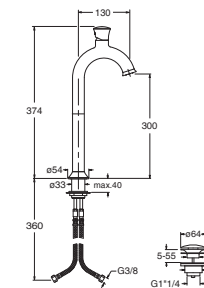

FN 222 TALL

Miscelatore monocomando
TALL per lavabo con scarico
Up&Down da 1"1/4

Waschtisch-Einhandmischer
TALL mit Ablaufgarnitur
Up&Down 1"1/4

Basin mixer TALL with 1"1/4
Up&Down waste

Mitigeur lavabo TALL avec vidage
Up&Down 1"1/4

FN 922 Senza scarico · Without waste · Ohne Ablaufgarnitur · Sans vidage

BIDET / BIDET

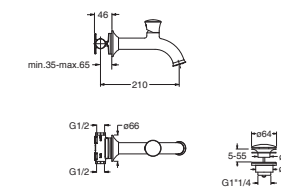

FN 232 REGULAR

Set completo per miscelatore
monocomando lavabo
REGULAR da incasso con scarico
Up&Down da 1"1/4

Unterputz-Waschtisch
Einhandmischer REGULAR
Wandmontage inkl. Einbaukörper
mit Ablaufgarnitur Up&Down 1"1/4

Complete wall mounted
basin mixer REGULAR with 1"1/4
Up&Down waste

Mitigeur lavabo encastré
REGULAR complet avec vidage
Up&Down 1"1/4

FN 932 Senza scarico · Without waste · Ohne Ablaufgarnitur · Sans vidage

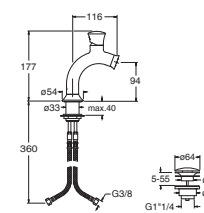

FN 320

Miscelatore monocomando
per bidet con scarico
Up&Down da 1"1/4

Bidet-Einhandmischer mit
Ablaufgarnitur Up&Down 1"1/4

Bidet mixer with 1"1/4
Up&Down waste

Mitigeur bidet avec vidage
Up&Down 1"1/4

FN 370 Senza scarico · Without waste · Ohne Ablaufgarnitur · Sans vidage

VASCA / BATH
WANNEN / BAIN DOUCHE

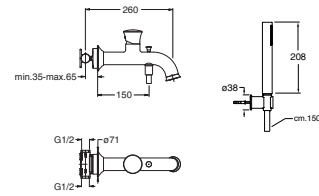

FN 100

Set completo per miscelatore monocomando vasca da incasso con flessibile LONG LIFE e doccetta anticalcare

Complete concealed bath mixer with LONG LIFE flexible hose and anti-lime hand shower

Unterputz Wannen-Einhandmischer inkl. Einbaukörper mit Brauseschlauch LONG LIFE und Handbrause mit Antikalk-System

Mitigeur bain douche encastré complet avec flexible LONG LIFE et douchette anticalcaire

DOCCIA / SHOWER
BRAUSE / DOUCHE

Fontana

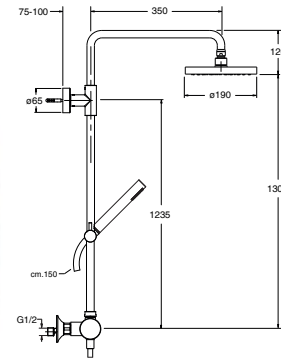

FN 456

Miscelatore termostatico per doccia esterno con colonna girevole, soffione anticalcare ispezionabile, doccetta anticalcare con supporto scorrevole e flessibile LONG LIFE

External thermostatic shower mixer with swivel column pipe, checkable anti-lime overhead shower, anti-lime hand shower with slide rail and LONG LIFE flexible hose

Thermostat-Brausebatterie Aufputz mit schwenkbarem Rohr, Kopfbrause mit Antikalk-System, Brauseschlauch LONG LIFE, Handbrause mit Antikalk-System und Gleitschieber

Colonne de douche orientable thermostatique avec pomme de douche anticalcaire démontable, douchette anticalcaire avec curseur réglable et flexible LONG LIFE

DOCCIA / SHOWER
BRAUSE / DOUCHE

Fontana

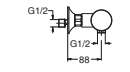

FN 451

Miscelatore termostatico per doccia esterno

External thermostatic shower mixer

Thermostat-Brausebatterie Aufputz

Mitigeur douche thermostatique extérieur

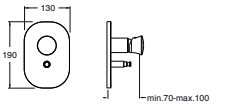

FN 689

Set da esterno per miscelatore monocomando doccia/vasca CS 535 con deviatore 2 uscite e piastra in metallo

Bath/shower mixer external parts for CS 535 with 2 outlet diverter and metal plate

Fertigmontageset Wannen/Brause-Einhandmischer für Einbaukörper CS 535 mit 2 Wege Umsteller und Abdeckplatte aus Metall

Façade externe pour mitigeur douche/bain douche 2 sorties pour mécanisme CS 535 avec plaque en métal

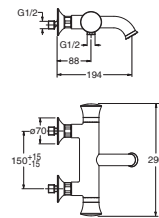

FN 157

Miscelatore termostatico per vasca esterno

External thermostatic bath mixer

Thermostat-Wannenbatterie Aufputz

Mitigeur thermostatique bain douche





LAVABO / BASIN
WASCHTISCH / LAVABO

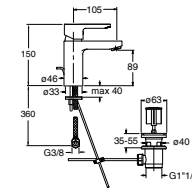

GE 221 REGULAR

Miscelatore monocomando REGULAR per lavabo con cartuccia C2 LLC WATER SAVING e scarico 1"1/4 con asta comando

Waschtisch-Einhandmischer REGULAR mit Kartusche C2 LLC WATER SAVING, Ablaufgarnitur 1"1/4 und Zugstange

Basin mixer REGULAR with C2 cartridge LLC WATER SAVING and 1"1/4 pop up waste

Mitigeur lavabo REGULAR avec cartouche C2 LLC WATER SAVING et vidage 1"1/4 à tirette

BIDET / BIDET

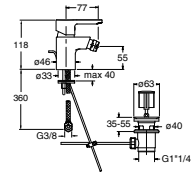

GE 321

Miscelatore monocomando per bidet con cartuccia C2 LLC WATER SAVING e scarico 1"1/4 con asta comando

Bidet-Einhandmischer mit Kartusche C2 LLC WATER SAVING, Ablaufgarnitur 1"1/4 und Zugstange

Bidet mixer with C2 cartridge LLC WATER SAVING and 1"1/4 pop up waste

Mitigeur bidet avec cartouche C2 LLC WATER SAVING et vidage 1"1/4 à tirette

VASCA / BATH
WANNEN / BAIN DOUCHE

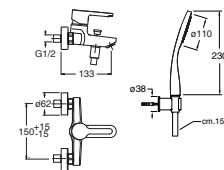

GE 100

Miscelatore monocomando per vasca esterno con cartuccia C2 LLC WATER SAVING, flessibile LONG LIFE e doccetta anticalcare

Wannen-Einhandmischer Aufputz mit Kartusche C2 LLC WATER SAVING, Brauseschlauch LONG LIFE und Handbrause mit Antikalk-System

External bath mixer with C2 cartridge LLC WATER SAVING, LONG LIFE flexible hose and anti-lime hand shower

Mitigeur bain douche extérieur avec cartouche C2 LLC WATER SAVING, flexible LONG LIFE et douchette anticalcaire

DOCCIA / SHOWER
BRAUSE / DOUCHE

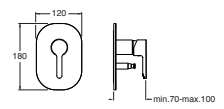

GE 659

Set da esterno per miscelatore monocomando doccia/vasca CS 535 con deviatore 2 uscite e piastra in ABS

Fertigmontageset Wannen/Brause-Einhandmischer mit 2 Wege Umsteller für Einbaukörper CS 535 und Abdeckplatte aus ABS

Bath/shower mixer external parts for CS 535 with 2 outlet diverter and ABS cover plate

Façade externe pour mitigeur douche/bain douche 2 sorties pour mécanisme CS 535 et plaque en ABS



LAVABO / BASIN WASCHTISCH / LAVABO

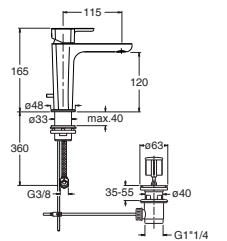

KG 211 REGULAR

Lavabi e bidet da piano sono disponibili con 2 diverse leve di comando

Standing washbasin and bidet taps are available with two different levers

Miscelatore monocomando REGULAR per lavabo con scarico 1"1/4 e asta comando

Basin mixer REGULAR with 1"1/4 pop up waste

Waschtisch- und Bidetmischer sind mit zwei verschiedenen Bedienhebeln erhältlich

Les lavabos et bidets sont disponibles avec deux poignées différentes

Waschtisch-Einhandmischer REGULAR mit Ablaufgarnitur 1"1/4 und Zugstange

Mitigeur lavabo REGULAR avec vidage 1"1/4 à tirette

KG 910 Senza scarico · Without waste · Ohne Ablaufgarnitur · Sans vidage

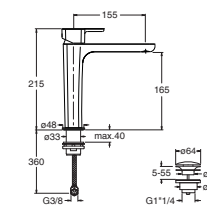

KG 217 MEDIUM

Miscelatore monocomando MEDIUM per lavabo con scarico Up&Down da 1"1/4

Basin mixer MEDIUM with 1"1/4 Up&Down waste

Waschtisch-Einhandmischer MEDIUM mit Ablaufgarnitur Up&Down 1"1/4

Mitigeur lavabo MEDIUM avec vidage Up&Down 1"1/4

KG 917 Senza scarico · Without waste · Ohne Ablaufgarnitur · Sans vidage

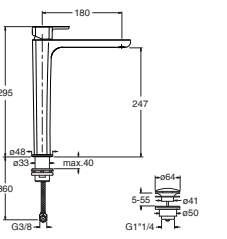

KG 212 TALL

Miscelatore monocomando TALL per lavabo con scarico Up&Down da 1"1/4

Basin mixer TALL with 1"1/4 Up&Down waste

Waschtisch-Einhandmischer TALL mit Ablaufgarnitur Up&Down 1"1/4

Mitigeur lavabo TALL avec vidage Up&Down 1"1/4

KG 912 Senza scarico · Without waste · Ohne Ablaufgarnitur · Sans vidage

LAVABO / BASIN
WASCHTISCH / LAVABO

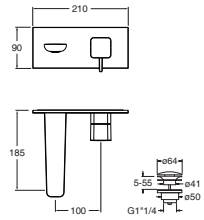

KG 276 REGULAR

Set da esterno per miscelatore monocomando lavabo REGULAR CS 237 - CS 238 con scarico Up&Down da 1"1/4 e piastra in metallo

Fertigmontageset Waschtisch-Einhandmischer REGULAR Wandmontage für Einbaukörper CS 237 - CS 238 mit Ablaufgarnitur Up&Down 1"1/4 und Abdeckplatte aus Metall

Wall mounted basin mixer REGULAR external parts for CS 237 - CS 238 with 1"1/4 Up&Down waste and metal plate

Façade externe mitigeur lavabo encastré REGULAR pour CS 237 - CS 238 avec vidage Up&Down 1"1/4 et plaque en métal

KG 976 Senza scarico * Without waste * Ohne Ablaufgarnitur * Sans vidage

BIDET / BIDET

King

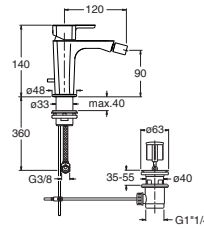

KG 311

Miscelatore monocomando per bidet con scarico 1"1/4 e asta comando

Bidet-Einhandmischer mit Ablaufgarnitur 1"1/4 und Zugstange

Bidet mixer with 1"1/4 pop up waste

Mitigeur bidet avec vidage 1"1/4 à tirette

KG 360 Senza scarico * Without waste * Ohne Ablaufgarnitur * Sans vidage

VASCA / BATH
WANNEN / BAIN DOUCHE

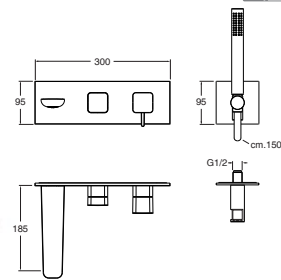

KG 108

Set da esterno per miscelatore monocomando doccia/vasca CS 137 con deviatore 2 uscite, doccetta anticalcare in ottone, flessibile LONG LIFE e piastra in metallo

Fertigmontageset Brause/Wannen-Einhandmischer mit 2 Wege Umsteller für Einbaukörper CS 137, Handbrause aus Messing mit Antikalk-System, Brauseschlauch LONG LIFE und Abdeckplatte aus Metall

Bath/shower mixer external parts for CS 137 with 2 outlet diverter, brass anti-lime hand shower, LONG LIFE flexible hose and metal plate

Façade externe mitigeur douche/bain douche encastré pour mécanisme CS 137 avec inverseur 2 sorties, douchette anticalcaire en laiton, flexible LONG LIFE et plaque en métal

DOCCIA / SHOWER
BRAUSE / DOUCHE

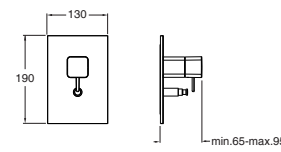

KG 689

Set da esterno per miscelatore monocomando doccia/vasca CS 535 con deviatore 2 uscite e piastra in metallo

Fertigmontageset Wannen/Brause-Einhandmischer für Einbaukörper CS 535 mit 2 Wege Umsteller und Abdeckplatte aus Metall

Bath/shower mixer external parts for CS 535 with 2 outlet diverter and metal plate

Façade externe pour mitigeur douche/bain douche 2 sorties pour mécanisme CS 535 avec plaque en métal



KG 276



KG 227



MD 220

LAVABO / BASIN WASCHTISCH / LAVABO

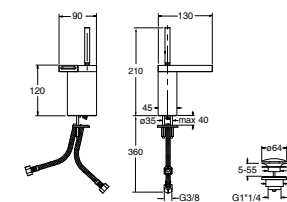

MD 220 REGULAR

Miscelatore monocomando per lavabo REGULAR con scarico Up&Down da 1"1/4

Basin mixer REGULAR with 1"1/4 Up&Down waste

Waschtisch-Einhandmischer REGULAR mit Ablaufgarnitur Up&Down 1"1/4

Mitigeur lavabo REGULAR avec vidage Up&Down 1"1/4

MD 920 Senza scarico · Without waste · Ohne Ablaufgarnitur · Sans vidage

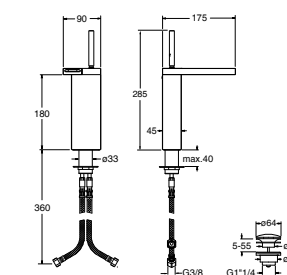

MD 223 MEDIUM

Miscelatore monocomando per lavabo MEDIUM con scarico Up&Down da 1"1/4

Basin mixer MEDIUM with 1"1/4 Up&Down waste

Waschtisch-Einhandmischer MEDIUM mit Ablaufgarnitur Up&Down 1"1/4

Mitigeur lavabo MEDIUM avec vidage Up&Down 1"1/4

MD 923 Senza scarico · Without waste · Ohne Ablaufgarnitur · Sans vidage

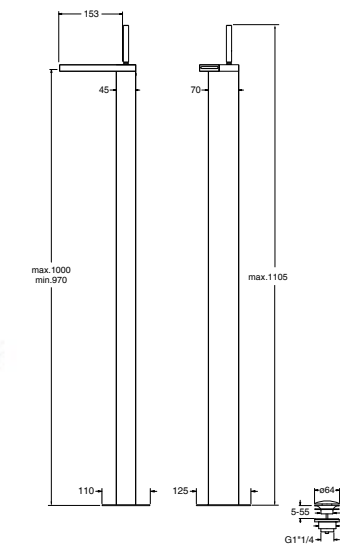

MD 289

Set da esterno per miscelatore monocomando lavabo a pavimento CS 290 con scarico Up&Down da 1"1/4

Floor mounted basin mixer external parts for CS 290 with 1"1/4 Up&Down waste

Fertigmontageset Waschtisch-Einhandmischer bodenstehend für Einbaukörper CS 290 mit Ablaufgarnitur Up&Down 1"1/4

Façade externe mitigeur lavabo sur pied pour mécanisme CS 290 avec vidage Up&Down 1"1/4

MD 989 Senza scarico · Without waste · Ohne Ablaufgarnitur · Sans vidage



LAVABO / BASIN
WASCHTISCH / LAVABO

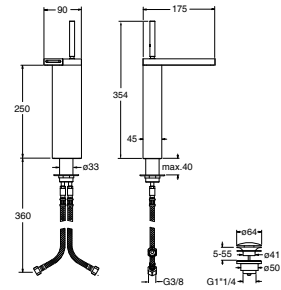

MD 222 TALL

Miscelatore monocomando TALL per lavabo con scarico Up&Down da 1"1/4

Waschtisch-Einhandmischer TALL mit Ablaufgarnitur Up&Down 1"1/4

Basin mixer TALL with 1"1/4 Up&Down waste

Mitigeur lavabo TALL avec vidage Up&Down 1"1/4

MD 922 Senza scarico · Without waste · Ohne Ablaufgarnitur · Sans vidage

BIDET / BIDET

Modul

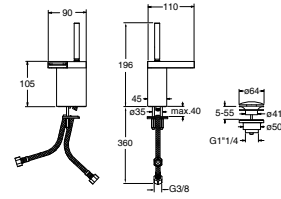

MD 320

Miscelatore monocomando per bidet con scarico Up&Down da 1"1/4

Bidet-Einhandmischer mit Ablaufgarnitur Up&Down 1"1/4

Bidet mixer with 1"1/4 Up&Down waste

Mitigeur bidet avec vidage Up&Down 1"1/4

MD 370 Senza scarico · Without waste · Ohne Ablaufgarnitur · Sans vidage

VASCA / BATH
WANNEN / BAIN DOUCHE

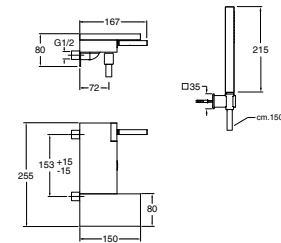

MD 100

Miscelatore monocomando per vasca esterno con flessibile LONG LIFE e doccetta anticalcare

Wannen-Einhandmischer Aufputz mit Brauseschlauch LONG LIFE und Handbrause mit Antikalk-System

External bath mixer with LONG LIFE flexible hose and anti-lime hand shower

Mitigeur bain douche extérieur avec flexible LONG LIFE et douchette anticalcaire

MD 121

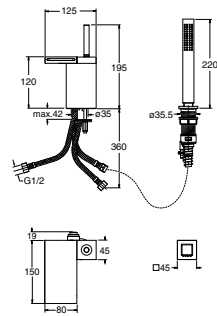

Miscelatore monocomando per bordo vasca 2 fori con deviatore, doccetta anticalcare estraibile e FOLLOW ME

2-Loch Wannenrand-Einhandmischer mit Umsteller, herausziehbarer Handbrause mit Antikalk-System und FOLLOW ME - Funktion

2 hole deck mounted bath mixer with diverter, pull-out anti-lime hand shower and FOLLOW ME

Mitigeur bain douche sur gorge 2 trous avec inverseur, douchette anticalcaire extractible et FOLLOW ME

VASCA / BATH
WANNEN / BAIN DOUCHE

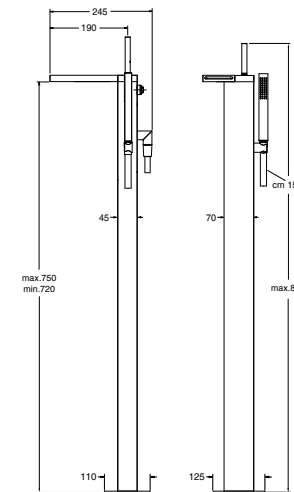

MD 190

Set da esterno per miscelatore monocomando vasca a pavimento CS 290 con flessibile LONG LIFE e doccetta anticalcare

Fertigmontageset Wannen-Einhandmischer bodenstehend für Einbaukörper CS 290 mit Brauseschlauch LONG LIFE und Handbrause mit Antikalk-System

Floor mounted bath mixer external parts for CS 290 with LONG LIFE flexible hose and anti-lime hand shower

Façade externe mitigeur bain douche sur pied pour mécanisme CS 290 avec flexible LONG LIFE et douchette anticalcaire

DOCCIA / SHOWER
BRAUSE / DOUCHE

Modul

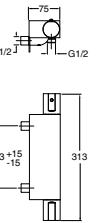

MD 451

Miscelatore termostatico per doccia esterno

Thermostat-Brausebatterie Aufputz

External thermostatic shower mixer

Mitigeur douche thermostatique extérieur

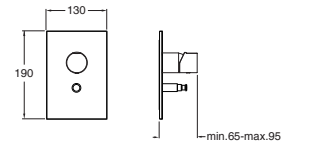

MD 689

Set da esterno per miscelatore monocomando doccia/vasca CS 535 con deviatore 2 uscite e piastra in metallo

Fertigmontageset Wannen/Brause-Einhandmischer für Einbaukörper CS 535 mit 2 Wege Umsteller und Abdeckplatte aus Metall

Bath/shower mixer external parts for CS 535 with 2 outlet diverter and metal plate

Façade externe pour mitigeur douche/bain douche 2 sorties pour mécanisme CS 535 avec plaque en métal



OG 220

LAVABO / BASIN
WASCHTISCH / LAVABO

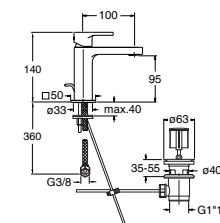

OG 221 REGULAR

Miscelatore monocomando REGULAR per lavabo con scarico 1"1/4 e asta comando

Basin mixer REGULAR with 1"1/4 pop up waste

Waschtisch-Einhandmischer REGULAR mit Ablaufgarnitur 1"1/4 und Zugstange

Mitigeur lavabo REGULAR avec vidage 1"1/4 à tirette

OG 920 Senza scarico · Without waste · Ohne Ablaufgarnitur · Sans vidage

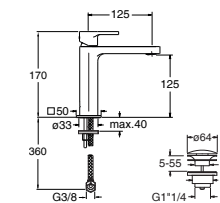

OG 227 MEDIUM

Miscelatore monocomando MEDIUM per lavabo con scarico Up&Down da 1"1/4

Basin mixer MEDIUM with 1"1/4 Up&Down waste

Waschtisch-Einhandmischer MEDIUM mit Ablaufgarnitur Up&Down 1"1/4

Mitigeur lavabo MEDIUM avec vidage Up&Down 1"1/4

OG 927 Senza scarico · Without waste · Ohne Ablaufgarnitur · Sans vidage

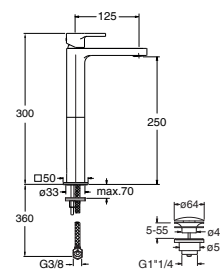

OG 222 TALL

Miscelatore monocomando TALL per lavabo con scarico Up&Down da 1"1/4

Basin mixer TALL with 1"1/4 Up&Down waste

Waschtisch-Einhandmischer TALL mit Ablaufgarnitur Up&Down 1"1/4

Mitigeur lavabo TALL avec vidage Up&Down 1"1/4

OG 922 Senza scarico · Without waste · Ohne Ablaufgarnitur · Sans vidage

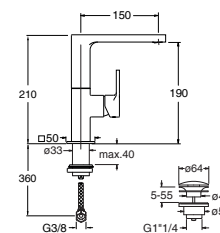

OG 228 REGULAR

Miscelatore monocomando REGULAR per lavabo con bocca girevole e scarico Up&Down da 1"1/4

Basin mixer REGULAR with swivel spout and 1"1/4 Up&Down waste

Waschtisch-Einhandmischer REGULAR mit schwenkbarem Auslauf und Ablaufgarnitur Up&Down 1"1/4

Mitigeur lavabo REGULAR avec bec orientable et vidage Up&Down 1"1/4

OG 928 Senza scarico · Without waste · Ohne Ablaufgarnitur · Sans vidage

LAVABO / BASIN
WASCHTISCH / LAVABO

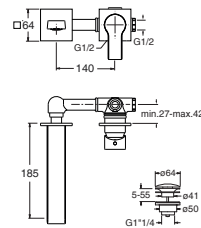

OG 237 REGULAR

Set completo per miscelatore monocomando lavabo REGULAR da incasso con scarico Up&Down da 1"1/4

Unterputz-Waschtisch Einhandmischer REGULAR Wandmontage inkl. Einbaukörper mit Ablaufgarnitur Up&Down 1"1/4

Complete wall mounted basin mixer REGULAR with 1"1/4 Up&Down waste

Mitigeur lavabo encastré REGULAR complet avec vidage Up&Down 1"1/4

OG 937 Senza scarico · Without waste · Ohne Ablaufgarnitur · Sans vidage

BIDET / BIDET

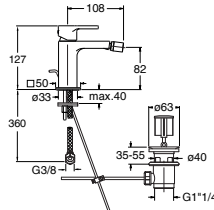

OG 321

Miscelatore monocomando per bidet con scarico 1"1/4 e asta comando

Bidet-Einhandmischer mit Ablaufgarnitur 1"1/4 und Zugstange

Bidet mixer with 1"1/4 pop up waste

Mitigeur bidet avec vidage 1"1/4 à tirette

OG 370 Senza scarico · Without waste · Ohne Ablaufgarnitur · Sans vidage

Omega



VASCA / BATH
WANNEN / BAIN DOUCHE

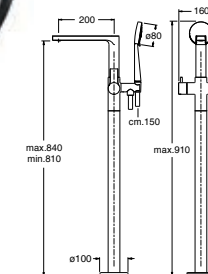
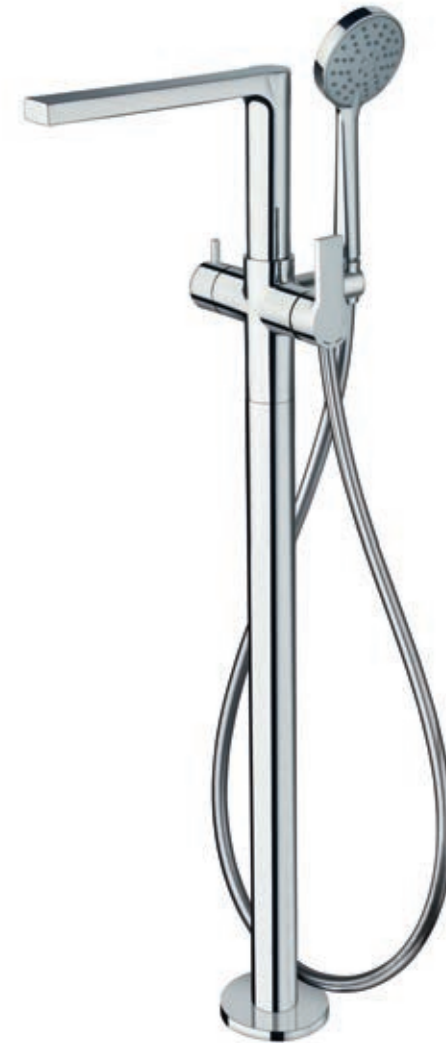

OG 189

Set da esterno per miscelatore monocomando vasca a pavimento CS 290 con flessibile LONG LIFE e doccetta anticalcare con miscelazione indipendente

Fertigmontageset Wannen-Einhandmischer bodenstehend für Einbaukörper CS 290 mit Brauseschlauch LONG LIFE und Handbrause mit Antikalk-System und separater Mischung

Floor mounted bath mixer external parts for CS 290 with LONG LIFE flexible hose and anti-lime hand shower with independent mixing

Façade externe mitigeur bain douche sur pied pour mécanisme CS 290 avec flexible LONG LIFE et douchette anticalcaire avec mélange indépendant

DOCCIA / SHOWER
BRAUSE / DOUCHE

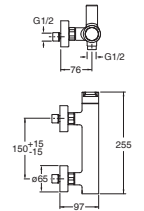

OG 481

Miscelatore monocomando per doccia esterno

Brause-Einhandmischer Aufputz

External shower mixer

Mitigeur douche extérieur

OG 689

VASCA / BATH
WANNEN / BAIN DOUCHE

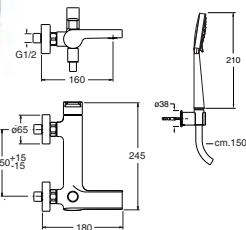

OG 180

Miscelatore monocomando per vasca esterno con flessibile LONG LIFE e doccetta comfort anticalcare

Wannen-Einhandmischer Aufputz mit Brauseschlauch LONG LIFE und Komfort Handbrause mit Antikalk-System

External bath mixer with LONG LIFE flexible hose and anti-lime comfort hand shower

Mitigeur bain douche extérieur avec flexible LONG LIFE et douchette anticalcaire confort

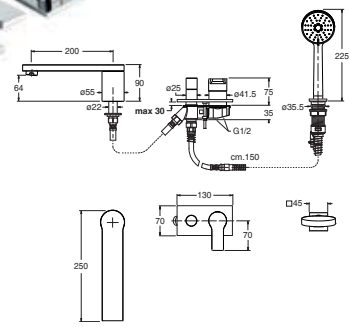
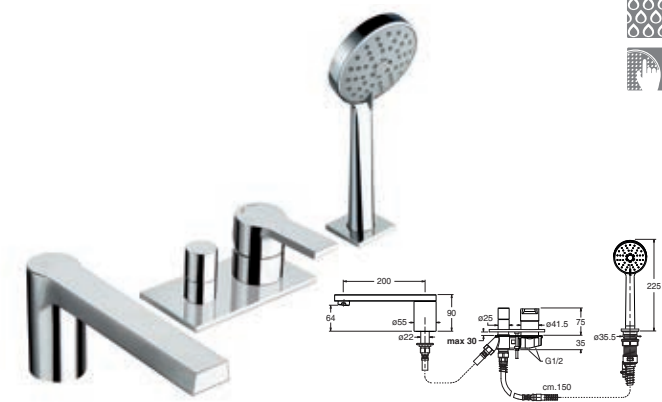

OG 121

Miscelatore monocomando per bordo vasca 4 fori con deviatore bocca erogazione, doccetta comfort anticalcare estraibile, FOLLOW ME e piastra in metallo

4-Loch Wannenrand-Einhandmischer mit Umsteller, Wanneneinlauf, herausziehbarer Handbrause, FOLLOW ME - Funktion und Abdeckplatte aus Metall

4 hole deck mounted bath mixer with diverter, spout, pull-out anti-lime comfort hand shower, FOLLOW ME and metal plate

Mitigeur bain douche sur gorge 4 trous avec inverseur, bec de remplissage, douchette anticalcaire extractible, FOLLOW ME et plaque en métal

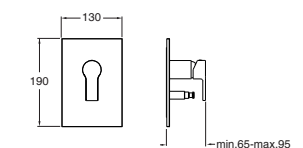

OG 689

Set da esterno per miscelatore monocomando doccia/vasca CS 535 con deviatore 2 uscite e piastra in metallo

Fertigmontageset Wannen/Brause-Einhandmischer für Einbaukörper CS 535 mit 2 Wege Umsteller und Abdeckplatte aus Metall

Bath/shower mixer external parts for CS 535 with 2 outlet diverter and metal cover plate

Façade externe pour mitigeur douche/bain douche 2 sorties pour mécanisme CS 535 avec plaque en métal



PM 221

LAVABO / BASIN
WASCHTISCH / LAVABO

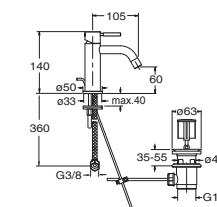

PM 221 REGULAR

Miscelatore monocomando REGULAR per lavabo con scarico 1"1/4 e asta comando

Basin mixer REGULAR with 1"1/4 pop up waste

Waschtisch-Einhandmischer REGULAR mit Ablaufgarnitur 1"1/4 und Zugstange

Mitigeur lavabo REGULAR avec vidage 1"1/4 à trette

PM 920 Senza scarico · Without waste · Ohne Ablaufgarnitur · Sans vidage

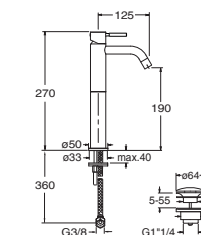

PM 222 TALL

Miscelatore monocomando TALL per lavabo con scarico Up&Down da 1"1/4

Basin mixer TALL with 1"1/4 Up&Down waste

Waschtisch-Einhandmischer TALL mit Ablaufgarnitur Up&Down 1"1/4

Mitigeur lavabo TALL avec vidage Up&Down 1"1/4

PM 922 Senza scarico · Without waste · Ohne Ablaufgarnitur · Sans vidage

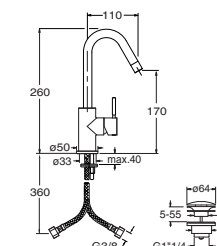

PM 226 REGULAR

Miscelatore monocomando REGULAR per lavabo con scarico Up&Down da 1"1/4

Basin mixer REGULAR with 1"1/4 Up&Down waste

Waschtisch-Einhandmischer REGULAR mit Ablaufgarnitur Up&Down 1"1/4

Mitigeur lavabo REGULAR avec vidage Up&Down 1"1/4

PM 926 Senza scarico · Without waste · Ohne Ablaufgarnitur · Sans vidage

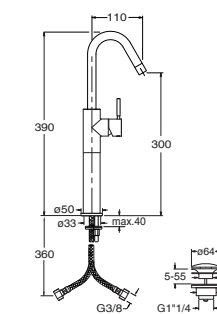

PM 228 TALL

Miscelatore monocomando TALL per lavabo con scarico Up&Down da 1"1/4

Basin mixer TALL with 1"1/4 Up&Down waste

Waschtisch-Einhandmischer TALL mit Ablaufgarnitur Up&Down 1"1/4

Mitigeur lavabo TALL avec vidage Up&Down 1"1/4

PM 928 Senza scarico · Without waste · Ohne Ablaufgarnitur · Sans vidage



LAVABO / BASIN
WASCHTISCH / LAVABO

BIDET / BIDET

Pic

DOCCIA / SHOWER
BRAUSE / DOUCHE

Pic

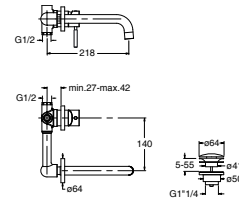

PM 237 REGULAR

Set completo per miscelatore monocomando lavabo REGULAR da incasso con scarico Up&Down da 1"1/4

Unterputz-Waschtisch-Einhandmischer REGULAR Wandmontage inkl. Einbaukörper mit Ablaufgarnitur Up&Down 1"1/4

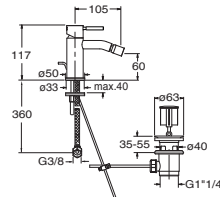

PM 321

Miscelatore monocomando per bidet con scarico 1"1/4 e asta comando

Bidet-Einhandmischer mit Ablaufgarnitur 1"1/4 und Zugstange

Bidet mixer with 1"1/4 pop up waste

Mitigeur bidet avec vidage 1"1/4 à tirette

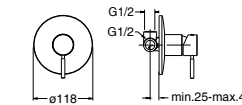

PM 118

Set completo per miscelatore monocomando doccia da incasso con piastra in metallo

Unterputz Brause Einhandmischer inkl. Einbaukörper mit Abdeckplatte aus Metall

Complete concealed shower mixer with metal plate

Mitigeur douche encastré complet avec plaque en métal

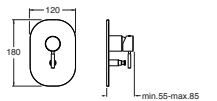

PM 659

Set da esterno per miscelatore monocomando doccia/vasca CS 535 con deviatore 2 uscite e piastra in ABS

Fertigmontageset Wannen/Brause-Einhandmischer mit 2 Wege Umsteller für Einbaukörper CS 535 und Abdeckplatte aus ABS

Bath/shower mixer external parts for CS 535 with 2 outlet diverter and ABS cover plate

Façade externe pour mitigeur douche/bain douche 2 sorties pour mécanisme CS 535 et plaque en ABS

PM 937 Senza scarico · Without waste · Ohne Ablaufgarnitur · Sans vidage

PM 370 Senza scarico · Without waste · Ohne Ablaufgarnitur · Sans vidage

BIDET / BIDET



VASCA / BATH
WANNEN / BAIN DOUCHE

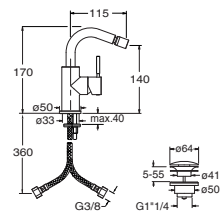

PM 326

Miscelatore monocomando per bidet con scarico Up&Down da 1"1/4

Bidet-Einhandmischer mit Ablaufgarnitur Up&Down 1"1/4

Basin mixer TALL with 1"1/4 Up&Down waste

Mitigeur bidet avec vidage Up&Down 1"1/4

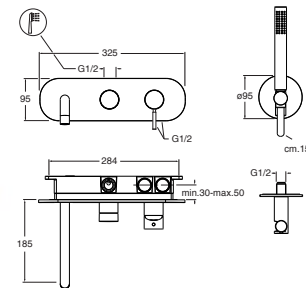

PM 108

Set completo per miscelatore monocomando doccia/vasca da incasso con deviatore 2 uscite, doccetta anticalcare, flessibile LONG LIFE e piastra in metallo

Unterputz Brause/Wannen-Einhandmischer inkl. Einbaukörper mit 2 Wege Umsteller, Handbrause mit Antikalk-System, Brauseschlauch LONG LIFE und Abdeckplatte aus Metall

Complete concealed bath/shower mixer with 2 outlet diverter, anti-lime hand shower, LONG LIFE flexible hose and metal plate

Mitigeur douche/bain douche encastré complet avec inverseur 2 sorties, douchette anticalcaire, flexible LONG LIFE et plaque en métal

PM 376 Senza scarico · Without waste · Ohne Ablaufgarnitur · Sans vidage





QM 220

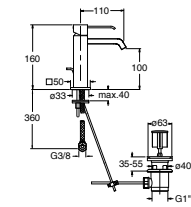

QM 221 REGULAR

Miscelatore monocomando REGULAR per lavabo con scarico 1"1/4 e asta comando

Basin mixer REGULAR with 1"1/4 pop up waste

Waschtisch-Einhandmischer REGULAR mit Ablaufgarnitur 1"1/4 und Zugstange

Mitigeur lavabo REGULAR avec vidage 1"1/4 à trette

QM 920 Senza scarico · Without waste · Ohne Ablaufgarnitur · Sans vidage

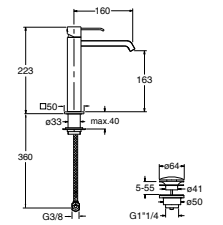

QM 227 MEDIUM

Miscelatore monocomando MEDIUM per lavabo con scarico Up&Down da 1"1/4

Basin mixer MEDIUM with 1"1/4 Up&Down waste

Waschtisch-Einhandmischer MEDIUM mit Ablaufgarnitur Up&Down 1"1/4

Mitigeur lavabo MEDIUM avec vidage Up&Down 1"1/4

QM 927 Senza scarico · Without waste · Ohne Ablaufgarnitur · Sans vidage

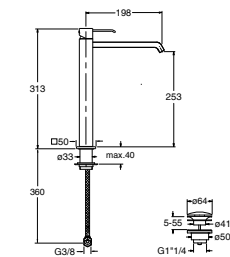

QM 228 TALL

Miscelatore monocomando TALL per lavabo con scarico Up&Down da 1"1/4

Basin mixer TALL with 1"1/4 Up&Down waste

Waschtisch-Einhandmischer TALL mit Ablaufgarnitur Up&Down 1"1/4

Mitigeur lavabo TALL avec vidage Up&Down 1"1/4

QM 928 Senza scarico · Without waste · Ohne Ablaufgarnitur · Sans vidage

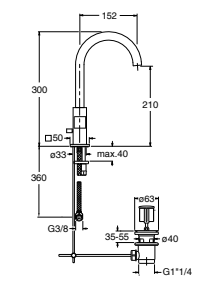

QD 226 REGULAR

Miscelatore bicomando REGULAR per lavabo con scarico 1"1/4 e asta comando

Basin mixer REGULAR with 1"1/4 pop up waste

Zweigriff-Waschtischbatterie REGULAR mit Ablaufgarnitur 1"1/4 und Zugstange

Mélangeur lavabo REGULAR avec vidage 1"1/4 à trette

QD 920 Senza scarico · Without waste · Ohne Ablaufgarnitur · Sans vidage

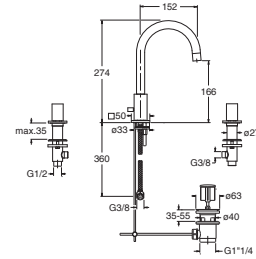
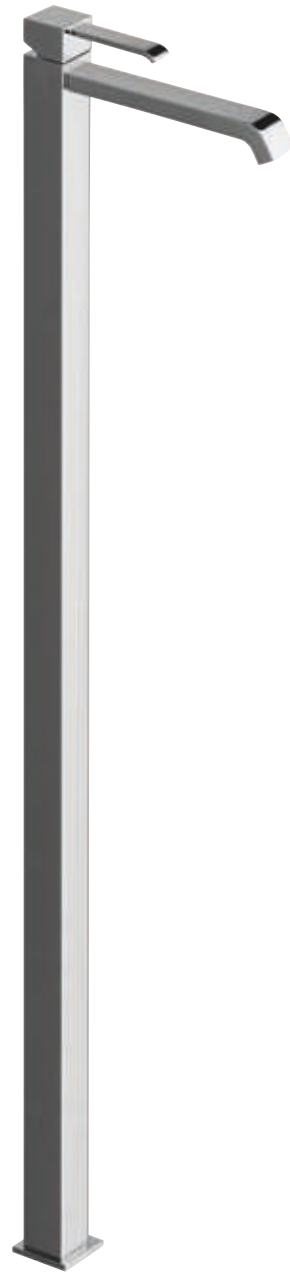

QD 205 REGULAR

Miscelatore bicomando REGULAR per lavabo 3 fori con scarico 1"1/4 e asta comando

3 hole basin mixer REGULAR with 1"1/4 pop up waste

3-Loch Waschtischbatterie REGULAR mit Ablaufgarnitur 1"1/4 und Zugstange

Mélangeur lavabo 3 trous REGULAR avec vidage 1"1/4 à tirette

QD 904 Senza scarico · Without waste · Ohne Ablaufgarnitur · Sans vidage

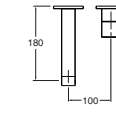
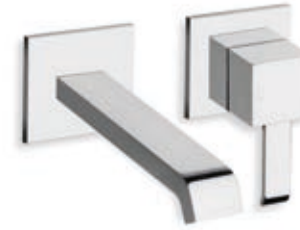

QM 277 REGULAR

Set da esterno per miscelatore monocomando lavabo REGULAR CS 237 - CS 238 con scarico Up&Down da 1"1/4

Wall mounted basin mixer REGULAR external parts for CS 237 - CS 238 with 1"1/4 Up&Down waste

Fertigmontageset Waschtisch-Einhandmischer REGULAR Wandmontage für Einbaukörper CS 237 - CS 238 mit Ablaufgarnitur Up&Down 1"1/4

Façade externe mitigeur lavabo encastré REGULAR pour mécanisme CS 237 - CS 238 avec vidage Up&Down 1"1/4

QM 977 Senza scarico · Without waste · Ohne Ablaufgarnitur · Sans vidage

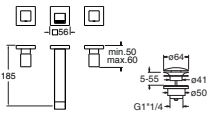
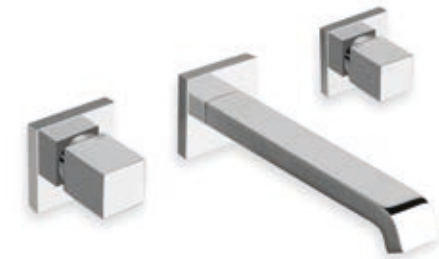

QD 242 REGULAR

Set da esterno miscelatore bicomando lavabo REGULAR per CS 233 - CS 234 con scarico Up&Down da 1"1/4

Wall mounted basin mixer REGULAR external parts for CS 233 - CS 234 with 1"1/4 Up&Down waste

Fertigmontageset Zweigriff-Waschtischbatterie REGULAR Wandmontage für Einbaukörper CS 233 - CS 234 mit Ablaufgarnitur Up&Down 1"1/4

Façade externe mélangeur lavabo encastré REGULAR pour mécanisme CS 233 - CS 234 avec vidage Up&Down 1"1/4

QD 942 Senza scarico · Without waste · Ohne Ablaufgarnitur · Sans vidage

BIDET / BIDET



QM 290

Set da esterno per miscelatore monocomando lavabo a pavimento CS 290 con scarico Up&Down da 1"1/4

Floor mounted basin mixer external parts for CS 290 with 1"1/4 Up&Down waste

Fertigmontageset Waschtisch-Einhandmischer bodenstehend für Einbaukörper CS 290 mit Ablaufgarnitur Up&Down 1"1/4

Façade externe mitigeur lavabo sur pied pour mécanisme CS 290 avec vidage Up&Down 1"1/4

QM 920 Senza scarico · Without waste · Ohne Ablaufgarnitur · Sans vidage

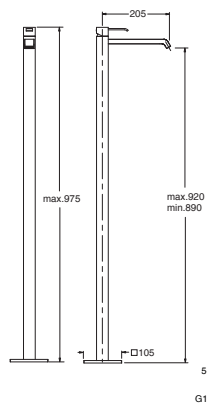

QM 276 REGULAR

Set da esterno per miscelatore monocomando lavabo REGULAR CS 237 - CS 238 con scarico Up&Down da 1"1/4 e piastra in metallo

Wall mounted basin mixer REGULAR external parts for CS 237 - CS 238 with 1"1/4 Up&Down waste and metal plate

Fertigmontageset Waschtisch-Einhandmischer REGULAR Wandmontage für Einbaukörper CS 237 - CS 238 mit Ablaufgarnitur Up&Down 1"1/4 und Abdeckplatte aus Metall

Façade externe mitigeur lavabo encastré REGULAR pour mécanisme CS 237 - CS 238 avec vidage Up&Down 1"1/4 et plaque en métal

QM 976 Senza scarico · Without waste · Ohne Ablaufgarnitur · Sans vidage

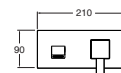

QM 321

Miscelatore monocomando per bidet con scarico 1"1/4 e asta comando

Bidet mixer with 1"1/4 pop up waste

Bidet-Einhandmischer mit Ablaufgarnitur 1"1/4 und Zugstange

Mitigeur bidet avec vidage 1"1/4 à tirette

QM 370 Senza scarico · Without waste · Ohne Ablaufgarnitur · Sans vidage

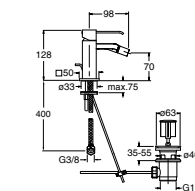

QD 326

Miscelatore bicomando per bidet con scarico 1"1/4 e asta comando

Bidet mixer with 1"1/4 pop up waste

Zweigriff-Bidetbatterie mit Ablaufgarnitur 1"1/4 und Zugstange

Mélangeur bidet avec vidage 1"1/4 à tirette

QD 370 Senza scarico · Without waste · Ohne Ablaufgarnitur · Sans vidage

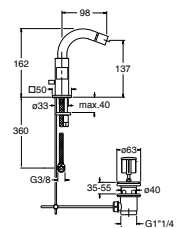

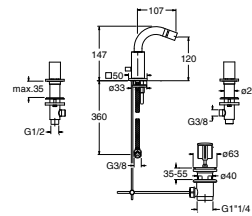

QD 330

Miscelatore bicomando per bidet 3 fori con scarico 1"1/4 e asta comando

3 hole bidet mixer with 1"1/4 pop up waste

3-Loch Bidetbatterie mit Ablaufgarnitur 1"1/4 und Zugstange

Mélangeur bidet 3 trous avec vidage 1"1/4 à trette

QD 379 Senza scarico * Without waste * Ohne Ablaufgarnitur * Sans vidage

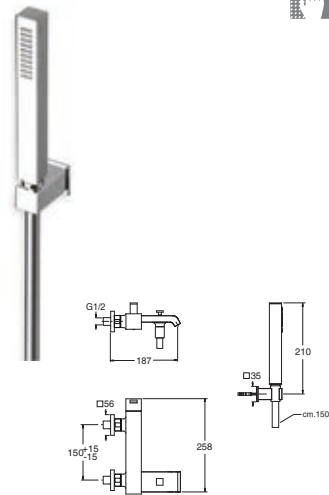

QM 100

Miscelatore monocomando per vasca esterno con flessibile LONG LIFE e doccetta anticalcare

External bath mixer with LONG LIFE flexible hose and anti-lime hand shower

Wannen-Einhandmischer Aufputz mit Brauseschlauch LONG LIFE und Handbrause mit Antikalk-System

Mitigeur bain douche extérieur avec flexible LONG LIFE et douchette anticalcaire

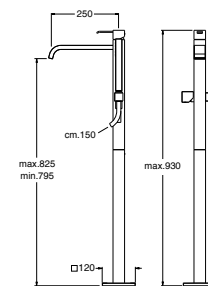

QM 189

Set da esterno per miscelatore monocomando vasca a pavimento CS 290 con flessibile LONG LIFE e doccetta anticalcare con miscelazione indipendente

Floor mounted bath mixer external parts for CS 290 with LONG LIFE flexible hose and anti-lime hand shower with independent mixing

Fertigmontageset Wannen-Einhandmischer bodenstehend für Einbaukörper CS 290 mit Brauseschlauch LONG LIFE und Handbrause mit Antikalk-System und separater Mischung

Façade externe mitigeur bain douche sur pied pour mécanisme CS 290 avec flexible LONG LIFE et douchette anticalcaire avec mélange indépendant

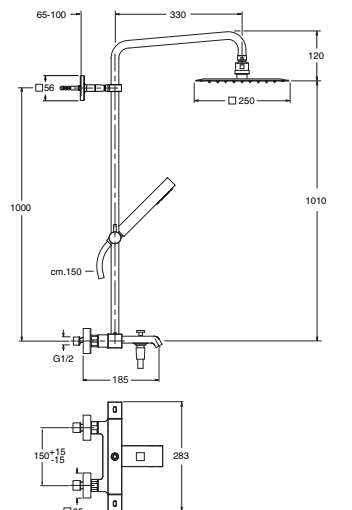

QD 188

Miscelatore termostatico "corpo freddo" per vasca esterno con colonna girevole, soffione SANDWICH SPECIAL 25x25 cm, doccetta anticalcare e flessibile LONG LIFE

Cold touch external thermostatic bath mixer with swivel column pipe, 25x25 cm SANDWICH SPECIAL overhead shower, anti-lime hand shower and LONG LIFE flexible hose

Termostat-Wannenbatterie Aufputz "Armaturenkörper mit Verbrühungsschutz" mit schwenkbarem Rohr, mit Kopfbrause SANDWICH SPECIAL 25 x 25 cm, Handbrause mit Antikalk-System und Brauseschlauch LONG LIFE

Colonne de bain douche orientable thermostatique "corps froid" avec pomme de douche SANDWICH SPECIAL 25 x 25 cm, douchette anticalcaire et flexible LONG LIFE

QD 100

Miscelatore bicomando per vasca esterno con flessibile LONG LIFE e doccetta anticalcare

External bath mixer with LONG LIFE flexible hose and anti-lime hand shower

Zweigriff-Wannenbatterie Aufputz mit Brauseschlauch LONG LIFE und Handbrause mit Antikalk-System

Mélangeur bain douche avec flexible LONG LIFE et douchette anticalcaire

QM 108

Set da esterno per miscelatore monocomando doccia/vasca CS 137 con deviatore 2 uscite, doccetta anticalcare, flessibile LONG LIFE e piastra in metallo

Bath/shower mixer external parts for CS 137 with 2 outlet diverter, anti-lime hand shower, LONG LIFE flexible hose and metal plate

Fertigmontageset Brause/Wannen-Einhandmischer für Einbaukörper CS 137 mit 2 Wege Umsteller, Handbrause mit Antikalk-System, Brauseschlauch LONG LIFE und Abdeckplatte aus Metall

Façade externe mitigeur douche/bain douche encastré pour mécanisme CS 137 avec inverseur 2 sorties, douchette anticalcaire, flexible LONG LIFE et plaque en métal

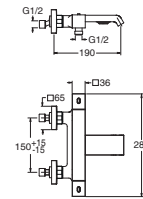

QD 187

Miscelatore termostatico "corpo freddo" per vasca esterno

"Cold touch" external thermostatic bath mixer

Thermostat-Wannenbatterie Aufputz "Armaturenkörper mit Verbrühungsschutz"

Mitigeur thermostatique bain douche "corps froid"

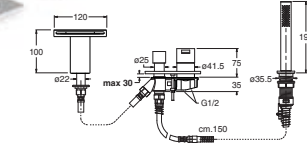
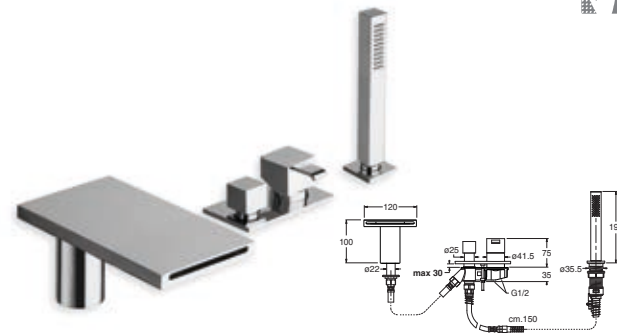

QM 181

Miscelatore monocomando per bordo vasca 4 fori con deviatore, bocca erogazione, doccetta anticalcare estraibile, FOLLOW ME e piastra in metallo

4 hole deck mounted bath mixer with diverter, spout, pull-out anti-lime hand shower, FOLLOW ME and metal plate

4-Loch Wannenrand-Einhandmischer mit Umsteller, Wanneneinlauf, herausziehbarer Handbrause, FOLLOW ME - Funktion und Abdeckplatte aus Metall

Mitigeur bain douche sur gorge 4 trous avec inverseur, bec de remplissage, douchette anticalcaire extractible, FOLLOW ME et plaque en métal

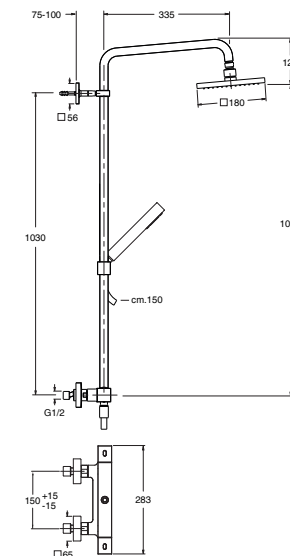

QD 478

Miscelatore termostatico "corpo freddo" per doccia esterno con colonna girevole, soffione anticalcare ispezionabile, doccetta anticalcare con supporto scorrevole e flessibile LONG LIFE

Cold touch external thermostatic shower mixer with swivel column pipe, checkable anti-lime overhead shower, anti-lime hand shower with slide rail and LONG LIFE flexible hose

Thermostat-Brausebatterie Aufputz "Armaturenkörper mit Verbrühungsschutz" mit schwenkbarem Rohr, Kopfbrause mit Antikalk-System, Brauseschlauch LONG LIFE, Handbrause mit Antikalk-System und Gleitschieber

Colonne de douche orientable thermostatique "corps froid" avec pomme de douche anticalcaire démontable, douchette anticalcaire avec curseur réglable et flexible LONG LIFE

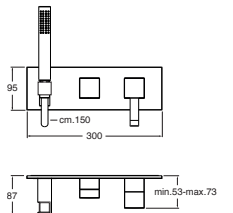

QM 608

Set da esterno per miscelatore monocomando doccia/vasca CS 137 con deviatore 2 uscite, doccetta anticalcare, flessibile LONG LIFE e piastra in metallo

Bath/shower mixer external parts for CS 137 with 2 outlet diverter, anti-lime hand shower, LONG LIFE flexible hose and metal plate

Fertigmontageset Brause/Wannen-Einhandmischer für Einbaukörper CS 137 mit 2 Wege Umsteller, Handbrause mit Antikalk-System, Brauseschlauch LONG LIFE und Abdeckplatte aus Metall

Façade externe mitigeur douche/bain douche encastré pour mécanisme CS 137 avec inverseur 2 sorties, douchette anticalcaire, flexible LONG LIFE et plaque en métal

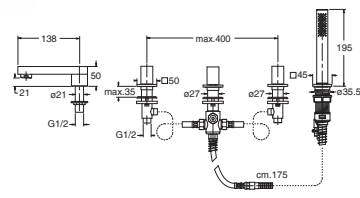
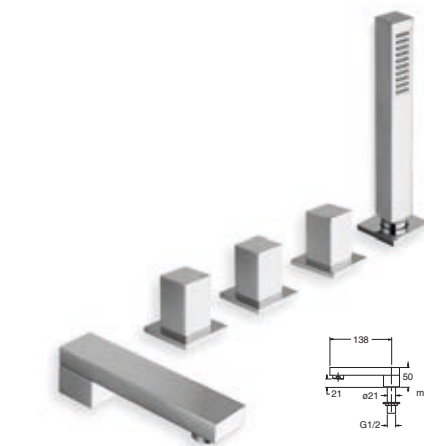

QD 121

Miscelatore bicomando per bordo vasca 5 fori con deviatore, bocca erogazione, doccetta anticalcare estraibile e FOLLOW ME

5 hole deck mounted bath mixer with diverter, spout, pull-out anti-lime hand shower and FOLLOW ME

5-Loch Wannenrandkombination mit Umsteller, Wanneneinlauf, herausziehbarer Handbrause mit Antikalk-System und FOLLOW ME - Funktion

Mélangeur bain douche sur gorge 5 trous avec inverseur, bec de remplissage, douchette anticalcaire extractible et FOLLOW ME

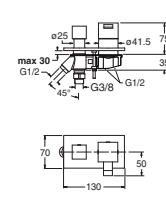

QM 129

Miscelatore monocomando per bordo vasca con deviatore 2 uscite e piastra in metallo

Deck mounted bath mixer with 2 outlet diverter and metal plate

Wannenrand-Einhandmischer mit 2 Wege Umsteller und Abdeckplatte aus Metall

Mitigeur bain douche sur gorge avec inverseur 2 sorties et plaque en métal

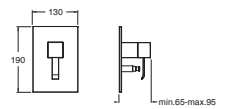

QM 689

Set da esterno per miscelatore monocomando doccia/vasca CS 535 con deviatore 2 uscite e piastra in metallo

Bath/shower mixer external parts for CS 535 with 2 outlet diverter and metal plate

Fertigmontageset Wannen/Brause-Einhandmischer für Einbaukörper CS 535 mit 2 Wege Umsteller und Abdeckplatte aus Metall

Façade externe pour mitigeur douche/bain douche 2 sorties pour mécanisme CS 535 avec plaque en métal



LAVABO / BASIN
WASCHTISCH / LAVABO

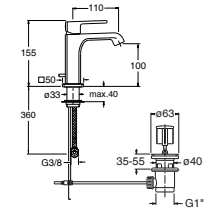

QS 221 REGULAR

Miscelatore monocomando REGULAR per lavabo con scarico 1"1/4 e asta comando

Basin mixer REGULAR with 1"1/4 pop up waste

Waschtisch-Einhandmischer REGULAR mit Ablaufgarnitur 1"1/4 und Zugstange

Mitigeur lavabo REGULAR avec vidage 1"1/4 à tirette

QS 920 Senza scarico · Without waste · Ohne Ablaufgarnitur · Sans vidage

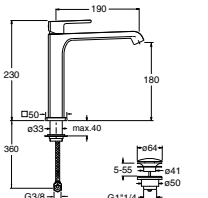

QS 227 MEDIUM

Miscelatore monocomando MEDIUM per lavabo con scarico Up&Down da 1"1/4

Basin mixer MEDIUM with 1"1/4 Up&Down waste

Waschtisch-Einhandmischer MEDIUM mit Ablaufgarnitur Up&Down 1"1/4

Mitigeur lavabo MEDIUM avec vidage Up&Down 1"1/4

QS 927 Senza scarico · Without waste · Ohne Ablaufgarnitur · Sans vidage

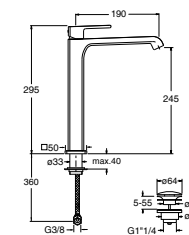

QS 222 TALL

Miscelatore monocomando TALL per lavabo con scarico Up&Down da 1"1/4

Basin mixer TALL with 1"1/4 Up&Down waste

Waschtisch-Einhandmischer TALL mit Ablaufgarnitur Up&Down 1"1/4

Mitigeur lavabo TALL avec vidage Up&Down 1"1/4

QS 922 Senza scarico · Without waste · Ohne Ablaufgarnitur · Sans vidage

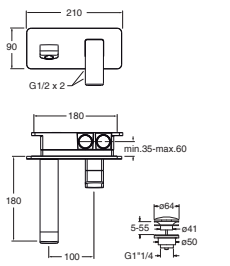

QS 276 REGULAR

Set completo per miscelatore monocomando lavabo REGULAR da incasso con scarico Up&Down da 1"1/4 e piastra in metallo

Complete wall mounted basin mixer REGULAR with 1"1/4 Up&Down waste and metal plate

Unterputz-Waschtisch-Einhandmischer REGULAR Wandmontage inkl. Einbaukörper mit Ablaufgarnitur Up&Down 1"1/4 und Abdeckplatte aus Metall

Mitigeur lavabo encastré REGULAR complet avec vidage Up&Down 1"1/4 et plaque en métal

QS 976 Senza scarico · Without waste · Ohne Ablaufgarnitur · Sans vidage

LAVABO / BASIN
WASCHTISCH / LAVABO

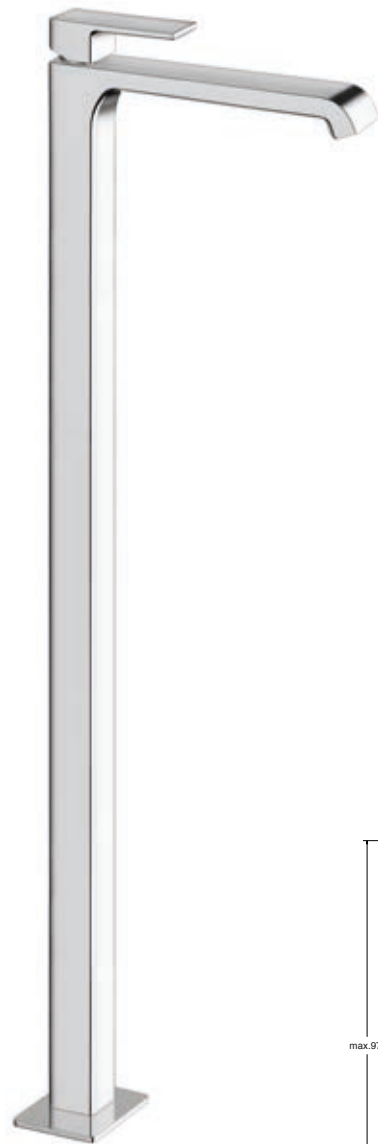

QS 290

Set da esterno per miscelatore monocomando lavabo a pavimento CS 290 con scarico Up&Down da 1"1/4

Fertigmontageset Waschtisch-Einhandmischer bodenstehend für Einbaukörper CS 290 mit Ablaufgarnitur Up&Down 1"1/4

QS 920 Senza scarico · Without waste · Ohne Ablaufgarnitur · Sans vidage

Floor mounted basin mixer external parts for CS 290 with 1"1/4 Up&Down waste

Façade externe mitigeur lavabo sur pied pour mécanisme CS 290 avec vidage Up&Down 1"1/4

BIDET / BIDET

Quadri S



QS 321

Miscelatore monocomando per bidet con scarico 1"1/4 e asta comando

Bidet-Einhandmischer mit Ablaufgarnitur 1"1/4 und Zugstange

QS 370 Senza scarico · Without waste · Ohne Ablaufgarnitur · Sans vidage

VASCA / BATH
WANNEN / BAIN DOUCHE



QS 100

Miscelatore monocomando per vasca esterno con flessibile LONG LIFE e doccia anticalcare

Wannen-Einhandmischer Aufputz mit Brauseschlauch LONG LIFE und Handbrause mit Antikalk-System

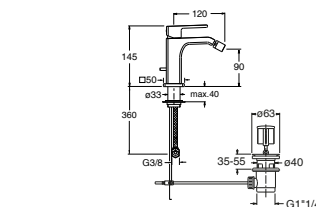

Bidet mixer with 1"1/4 pop up waste

Mitigeur bidet avec vidage 1"1/4 à tirette

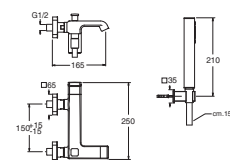

External bath mixer with LONG LIFE flexible hose and anti-lime hand shower

Mitigeur bain douche extérieur avec flexible LONG LIFE et douchette anticalcaire

VASCA / BATH
WANNEN / BAIN DOUCHE



QS 189

Set da esterno per miscelatore monocomando vasca a pavimento CS 290 con flessibile LONG LIFE e doccia anticalcare con miscelazione indipendente

Fertigmontageset Wannen-Einhandmischer bodenstehend für Einbaukörper CS 290 mit Brauseschlauch LONG LIFE und Handbrause mit Antikalk-System und separater Mischung

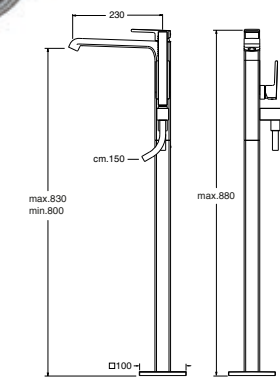

Floor mounted bath mixer external parts for CS 290 with LONG LIFE flexible hose and anti-lime hand shower with independent mixing

Façade externe mitigeur bain douche sur pied pour mécanisme CS 290 avec flexible LONG LIFE et douchette anticalcaire avec mélange indépendant

Quadri S



QS 108

Set completo per miscelatore monocomando doccia/vasca da incasso con deviatore 2 uscite, doccia anticalcare, flessibile LONG LIFE e piastra in metallo

Unterputz Brause/Wannen-Einhandmischer inkl. Einbaukörper mit 2 Wege Umsteller, Handbrause mit Antikalk-System, Brauseschlauch LONG LIFE und Abdeckplatte aus Metall

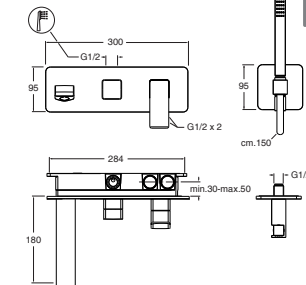

Complete concealed bath/shower mixer with 2 outlet diverter, anti-lime hand shower, LONG LIFE flexible hose and metal plate

Mitigeur douche/bain douche encastré complet avec inverseur 2 sorties, douchette anticalcaire, flexible LONG LIFE et plaque en métal

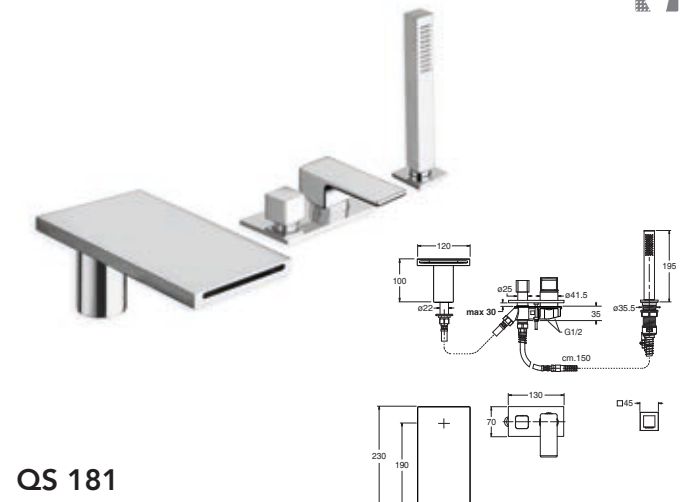

QS 181

Miscelatore monocomando per bordo vasca 4 fori con deviatore bocca erogazione, doccia anticalcare estraibile, FOLLOW ME e piastra in metallo

4-Loch Wannenrand-Einhandmischer mit Umsteller, Wanneneinlauf, herausziehbarer Handbrause, FOLLOW ME - Funktion und Abdeckplatte aus Metall

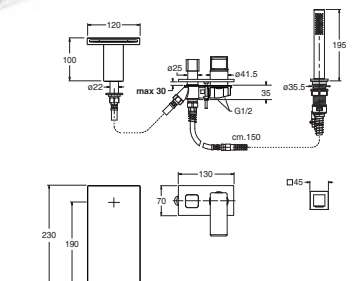

4 hole deck mounted bath mixer with diverter, spout, pull-out anti-lime hand shower, FOLLOW ME and metal plate

Mitigeur bain douche sur gorge 4 trous avec inverseur, bec de remplissage, douchette anticalcaire extractible, FOLLOW ME et plaque en métal

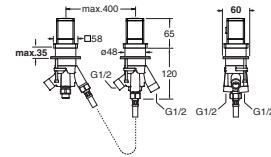

XQ 142

Miscelatore termostatico per bordo vasca con deviatore 2 uscite

Deck mounted thermostatic bath mixer with 2 outlet diverter

Thermostat Wannenrandbatterie mit 2 Wege Umsteller

Mitigeur thermostatique bain douche sur gorge avec inverseur 2 sorties

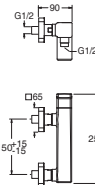

QS 401

Miscelatore monocomando per doccia esterno

External shower mixer

Brause-Einhandmischer Aufputz

Mitigeur douche extérieur

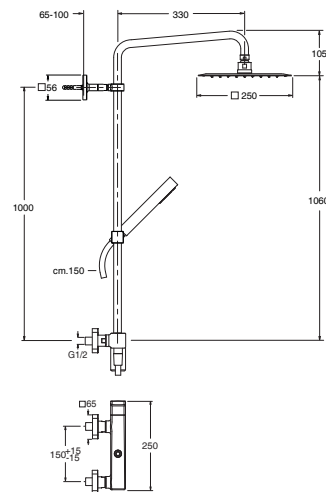
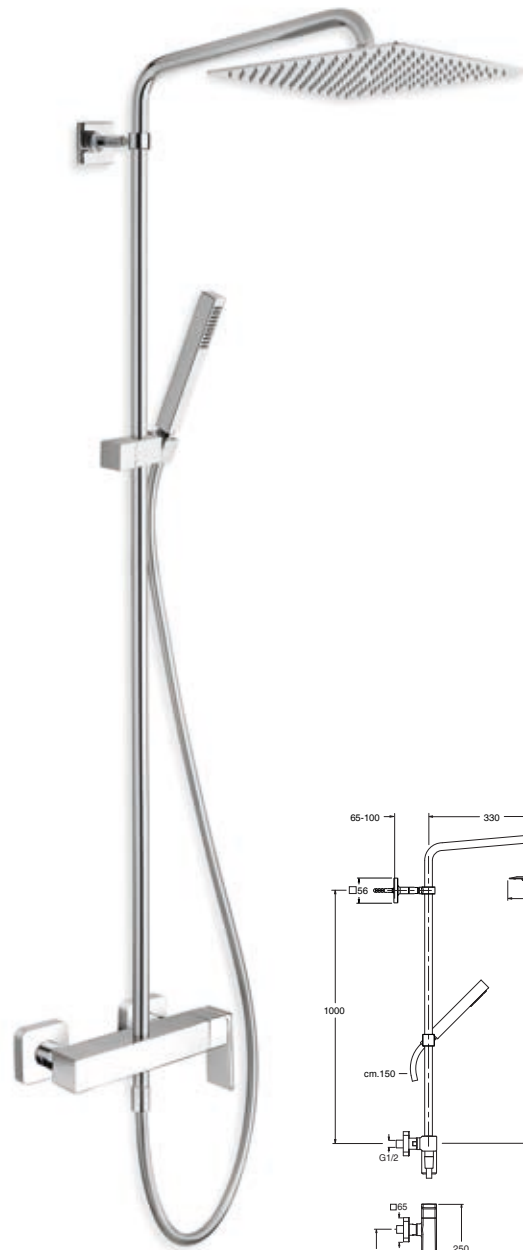

QS 409

Miscelatore monocomando per doccia esterno con colonna girevole, soffione SANDWICH SPECIAL 25 x 25 cm, flessibile LONG LIFE e doccetta anticalcare con supporto scorrevole

External shower mixer with swivel column pipe, 25 x 25 cm SANDWICH SPECIAL overhead shower, LONG LIFE flexible hose and anti-lime hand shower with slide rail

Brause-Einhandmischer Aufputz mit schwenkbarem Rohr, mit Kopfbrause SANDWICH SPECIAL 25 x 25 cm, Brauseschlauch LONG LIFE, Handbrause mit Antikalk-System und Gleitschieber

Mitigeur douche extérieur avec colonne orientable, pomme de douche SANDWICH SPECIAL 25 x 25 cm, flexible LONG LIFE et douchette anticalcaire avec curseur réglable

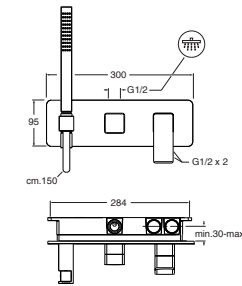

QS 608

Set completo per miscelatore monocomando doccia/vasca da incasso con deviatore 2 uscite, doccetta anticalcare e flessibile LONG LIFE

Complete concealed bath/shower mixer with 2 outlet diverter, anti-lime hand shower and LONG LIFE flexible hose

Unterputz Brause/Wannen-Einhandmischer inkl. Einbaukörper mit 2 Wege Umsteller, Handbrause mit Antikalk-System, Brauseschlauch LONG LIFE und Abdeckplatte aus Metall

Mitigeur douche/bain douche encastré complet avec inverseur 2 sorties, douchette anticalcaire, flexible LONG LIFE et plaque en métal

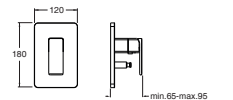

QS 689

Set da esterno per miscelatore monocomando doccia/vasca CS 535 con deviatore 2 uscite e piastra in metallo

Bath/shower mixer external parts for CS 535 with 2 outlet diverter and metal plate

Fertigmontageset Wannen/Brause-Einhandmischer für Einbaukörper CS 535 mit 2 Wege Umsteller und Abdeckplatte aus Metall

Façade externe pour mitigeur douche/bain douche 2 sorties pour mécanisme CS 535 avec plaque en métal





LAVABO / BASIN WASCHTISCH / LAVABO



Lavabi e bidet da piano sono disponibili con 2 diverse leve di comando

Waschtisch- und Bidetmischer sind mit zwei verschiedenen Bedienhebeln erhältlich.

Standing washbasin and bidet taps are available with two different levers

Les lavabos et bidets sont disponibles avec deux poignées différentes.



QE 211 REGULAR

Miscelatore monocomando REGULAR per lavabo con scarico 1"1/4 e asta comando

Waschtisch-Einhandmischer REGULAR mit Ablaufgarnitur 1"1/4 und Zugstange

Basin mixer REGULAR with 1"1/4 pop up waste

Mitigeur lavabo REGULAR avec vidage 1"1/4 á tirette

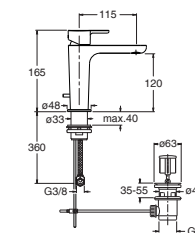

QE 910 Senza scarico · Without waste · Ohne Ablaufgarnitur · Sans vidage



QE 217 MEDIUM

Miscelatore monocomando MEDIUM per lavabo con scarico Up&Down da 1"1/4

Waschtisch-Einhandmischer MEDIUM mit Ablaufgarnitur Up&Down 1"1/4

Basin mixer MEDIUM with 1"1/4 Up&Down waste

Mitigeur lavabo MEDIUM avec vidage Up&Down 1"1/4

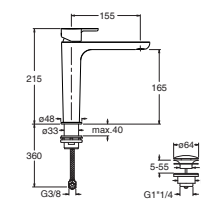

QE 917 Senza scarico · Without waste · Ohne Ablaufgarnitur · Sans vidage



QE 212 TALL

Miscelatore monocomando TALL per lavabo con scarico Up&Down da 1"1/4

Waschtisch-Einhandmischer TALL mit Ablaufgarnitur Up&Down 1"1/4

Basin mixer TALL with 1"1/4 Up&Down waste

Mitigeur lavabo TALL avec vidage Up&Down 1"1/4

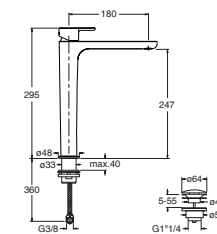

QE 912 Senza scarico · Without waste · Ohne Ablaufgarnitur · Sans vidage

LAVABO / BASIN
WASCHTISCH / LAVABO

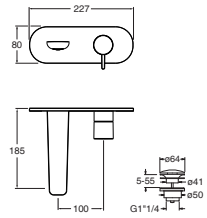

QE 276 REGULAR

Set da esterno per miscelatore monocomando lavabo REGULAR CS 237 - CS 238 con scarico Up&Down da 1"1/4 e piastra in metallo

Fertigmontageset Waschtisch-Einhandmischer REGULAR Wandmontage für Einbaukörper CS 237 - CS 238 mit Ablaufgarnitur Up&Down 1"1/4 und Abdeckplatte aus Metall

Wall mounted basin mixer REGULAR external parts for CS 237 - CS 238 with 1"1/4 Up&Down waste and metal plate

Façade externe mitigeur lavabo encastré REGULAR pour mécanisme CS 237 - CS 238 avec vidage Up&Down 1"1/4 et plaque en métal

QE 976 Senza scarico * Without waste * Ohne Ablaufgarnitur * Sans vidage

BIDET / BIDET

Queen

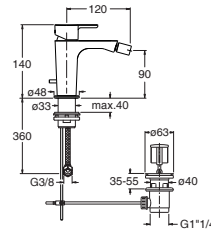

QE 311

Miscelatore monocomando per bidet con scarico 1"1/4 e asta comando

Bidet-Einhandmischer mit Ablaufgarnitur 1"1/4 und Zugstange

Bidet mixer with 1"1/4 pop up waste

Mitigeur bidet avec vidage 1"1/4 à tirette

QE 360 Senza scarico * Without waste * Ohne Ablaufgarnitur * Sans vidage

VASCA / BATH
WANNEN / BAIN DOUCHE

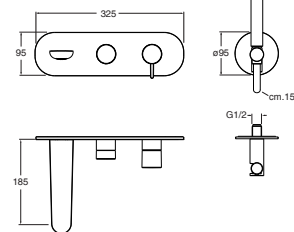

QE 108

Set da esterno per miscelatore monocomando doccia/vasca CS 137 con deviatore 2 uscite, doccetta anticalcare in ottone, flessibile LONG LIFE e piastra in metallo

Fertigmontageset Brause/Wannen-Einhandmischer mit 2 Wege Umsteller für Einbaukörper CS 137, Handbrause aus Messing mit Antikalk-System, Brauseschlauch LONG LIFE und Abdeckplatte aus Metall

Bath/shower mixer external parts for CS 137 with 2 outlet diverter, brass anti-lime hand shower, LONG LIFE flexible hose and metal plate

Façade externe mitigeur douche/bain douche encastré pour mécanisme CS 137 avec inverseur 2 sorties, douchette anticalcaire en laiton, flexible LONG LIFE et plaque en métal

DOCCIA / SHOWER
BRAUSE / DOUCHE

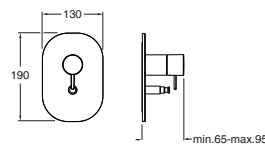

QE 689

Set da esterno per miscelatore monocomando doccia/vasca CS 535 con deviatore 2 uscite e piastra in metallo

Fertigmontageset Wannen/Brause-Einhandmischer für Einbaukörper CS 535 mit 2 Wege Umsteller und Abdeckplatte aus Metall

Bath/shower mixer external parts for CS 535 with 2 outlet diverter and metal plate

Façade externe pour mitigeur douche/bain douche 2 sorties pour mécanisme CS 535 avec plaque en métal





RN 222

LAVABO / BASIN
WASCHTISCH / LAVABO

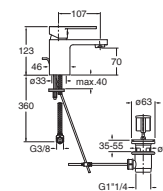

RN 221 REGULAR

Miscelatore monocomando REGULAR per lavabo con scarico 1"1/4 e asta comando

Basin mixer REGULAR with 1"1/4 pop up waste

Waschtisch-Einhandmischer REGULAR mit Ablaufgarnitur 1"1/4 und Zugstange

Mitigeur lavabo REGULAR avec vidage 1"1/4 à tirette

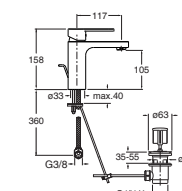

RN 222 LARGE

Miscelatore monocomando LARGE per lavabo con scarico 1"1/4 e asta comando

Basin mixer LARGE with 1"1/4 pop up waste

Waschtisch-Einhandmischer LARGE mit Ablaufgarnitur 1"1/4 und Zugstange

Mitigeur lavabo LARGE avec vidage 1"1/4 à tirette

BIDET / BIDET

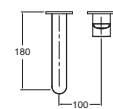

RN 267 REGULAR

Set da esterno per miscelatore monocomando lavabo CS 237 - CS 238 con scarico Up&Down da 1"1/4

Wall mounted basin mixer external parts for CS 237 - CS 238 with 1"1/4 Up&Down waste

Fertigmontageset Waschtisch-Einhandmischer REGULAR Wandmontage für Einbaukörper CS 237 - CS 238 mit Ablaufgarnitur Up&Down 1"1/4

Façade externe mitigeur lavabo encastré REGULAR pour mécanisme CS 237 - CS 238 avec vidage Up&Down 1"1/4

RN 967 Senza scarico · Without waste · Ohne Ablaufgarnitur · Sans vidage

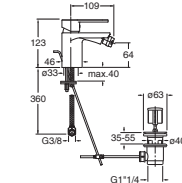

RN 321

Miscelatore monocomando per bidet con scarico 1"1/4 e asta comando

Bidet mixer with 1"1/4 pop up waste

Bidet-Einhandmischer mit Ablaufgarnitur 1"1/4 und Zugstange

Mitigeur bidet avec vidage 1"1/4 à tirette

BIDET / BIDET



RN 322

Miscelatore monocomando per bidet con scarico 1"1/4 e asta comando

Bidet-Einhandmischer mit Ablaufgarnitur 1"1/4 und Zugstange

Bidet mixer with 1"1/4 pop up waste

Mitigeur bidet avec vidage 1"1/4 á tirette

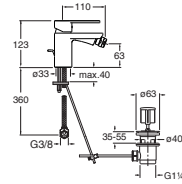

VASCA / BATH
WANNEN / BAIN DOUCHE

Round



RN 100

Miscelatore monocomando per vasca esterno con flessibile LONG LIFE e doccetta anticalcare

Wannen-Einhandmischer Aufputz mit Brauseschlauch LONG LIFE und Handbrause mit Antikalk-System

External bath mixer with LONG LIFE flexible hose and anti-lime hand shower

Mitigeur bain douche extérieur avec flexible LONG LIFE et douchette anticalcaire

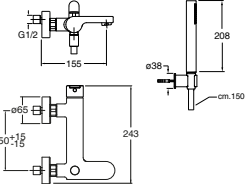

DOCCIA / SHOWER
BRAUSE / DOUCHE

Round



RN 409

Miscelatore monocomando per doccia esterno con colonna girevole, soffione SANDWICH SPECIAL ø20 cm, flessibile LONG LIFE e doccetta anticalcare con supporto scorrevole

Brause-Einhandmischer Aufputz mit schwenkbarem Rohr, mit Kopfbrause SANDWICH SPECIAL ø20 cm, Brauseschlauch LONG LIFE, Handbrause mit Antikalk-System und Gleitschieber

External shower mixer with swivel column pipe, ø20 cm SANDWICH SPECIAL overhead shower, LONG LIFE flexible hose and anti-lime hand shower with slide rail

Mitigeur douche extérieur avec colonne orientable, pomme de douche SANDWICH SPECIAL ø20 cm, flexible LONG LIFE et douchette anticalcaire avec curseur réglable

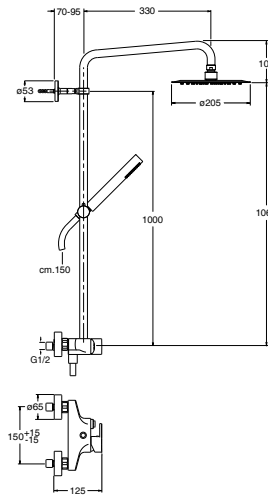

RN 686

Set da esterno per miscelatore monocomando doccia CS 535 con piastra in metallo

Fertigmontageset Brause-Einhandmischer für Einbaukörper CS 535 mit Abdeckplatte aus Metall

Shower mixer external parts for CS 535 with 1 outlet and metal plate

Façade externe pour mitigeur douche 1 sortie pour mécanisme CS 535 avec plaque en métal

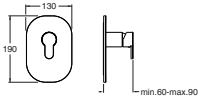

DOCCIA / SHOWER
BRAUSE / DOUCHE



RN 121

Miscelatore monocomando per bordo vasca 3 fori con deviatore bocca erogazione doccetta anticalcare estraibile e FOLLOW ME

3-Loch Wannenrand-Einhandmischer mit Umsteller, Wanneneinlauf, herausziehbarer Handbrause und FOLLOW ME - Funktion



3 hole deck mounted bath mixer with diverter, spout, pull-out anti-lime hand shower and FOLLOW ME

Mitigeur bain douche sur gorge 3 trous avec inverseur, bec de remplissage, douchette anticalcaire extractible et FOLLOW ME

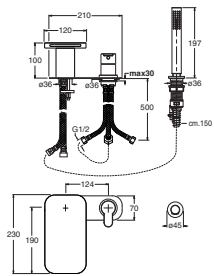

RN 401

Miscelatore monocomando per doccia esterno

Brause-Einhandmischer Aufputz

External shower mixer

Mitigeur douche extérieur

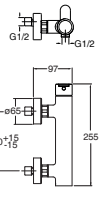

RN 689

Set da esterno per miscelatore monocomando doccia/vasca CS 535 con deviatore 2 uscite e piastra in metallo

Fertigmontageset Wannen/Brause-Einhandmischer für Einbaukörper CS 535 mit 2 Wege Umsteller und Abdeckplatte aus Metall

Bath/shower mixer external parts for CS 535 with 2 outlet diverter and metal plate

Façade externe pour mitigeur douche/bain douche 2 sorties pour mécanisme CS 535 avec plaque en métal

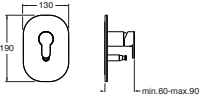



RU 224

LAVABO / BASIN WASCHTISCH / LAVABO

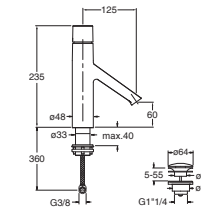

RU 224 REGULAR

Miscelatore monocomando REGULAR per lavabo con scarico Up&Down da 1"1/4

Waschtisch-Einhandmischer REGULAR mit Ablaufgarnitur Up&Down 1"1/4

Basin mixer REGULAR with 1"1/4 Up&Down waste

Mitigeur lavabo REGULAR avec vidage Up&Down 1"1/4

RU 924 Senza scarico · Without waste · Ohne Ablaufgarnitur · Sans vidage

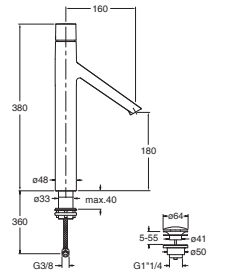

RU 229 MEDIUM

Miscelatore monocomando MEDIUM per lavabo con scarico Up&Down da 1"1/4

Waschtisch-Einhandmischer MEDIUM mit Ablaufgarnitur Up&Down 1"1/4

Basin mixer MEDIUM with 1"1/4 Up&Down waste

Mitigeur lavabo MEDIUM avec vidage Up&Down 1"1/4

RU 929 Senza scarico · Without waste · Ohne Ablaufgarnitur · Sans vidage

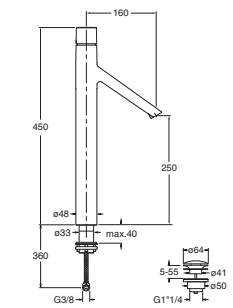

RU 228 TALL

Miscelatore monocomando TALL per lavabo con scarico Up&Down da 1"1/4

Waschtisch-Einhandmischer TALL mit Ablaufgarnitur Up&Down 1"1/4

Basin mixer TALL with 1"1/4 Up&Down waste

Mitigeur lavabo TALL avec vidage Up&Down 1"1/4

RU 928 Senza scarico · Without waste · Ohne Ablaufgarnitur · Sans vidage

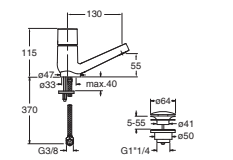

RU 220 REGULAR

Miscelatore monocomando REGULAR per lavabo con scarico Up&Down da 1"1/4

Waschtisch-Einhandmischer REGULAR mit Ablaufgarnitur 1"1/4

Basin mixer REGULAR with 1"1/4 Up&Down waste

Mitigeur lavabo REGULAR avec vidage 1"1/4

RU 920 Senza scarico · Without waste · Ohne Ablaufgarnitur · Sans vidage

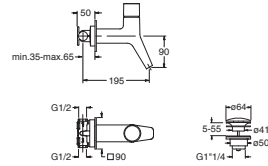

RU 232 REGULAR

Set completo per miscelatore monocomando lavabo REGULAR da incasso con scarico Up&Down da 1"1/4

Complete wall mounted basin mixer REGULAR with 1"1/4 Up&Down waste

Unterputz-Waschtisch-Einhandmischer REGULAR Wandmontage inkl. Einbaukörper mit Ablaufgarnitur Up&Down 1"1/4

Mitigeur lavabo encastré complet REGULAR avec vidage Up&Down 1"1/4

RU 932 Senza scarico · Without waste · Ohne Ablaufgarnitur · Sans vidage

BIDET / BIDET

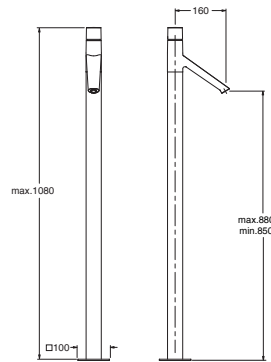

RU 290

Set da esterno per miscelatore monocomando lavabo a pavimento CS 290 con scarico Up&Down da 1"1/4

Floor mounted basin mixer external parts for CS 290 with 1"1/4 Up&Down waste

Fertigmontageset Waschtisch-Einhandmischer bodenstehend für Einbaukörper CS 290 mit Ablaufgarnitur Up&Down 1"1/4

Façade externe mitigeur lavabo sur pied pour mécanisme CS 290 avec vidage Up&Down 1"1/4

RU 990 Senza scarico · Without waste · Ohne Ablaufgarnitur · Sans vidage



RU 324

Miscelatore monocomando per bidet con scarico Up&Down da 1"1/4

Bidet mixer with 1"1/4 Up&Down waste

Bidet-Einhandmischer mit Ablaufgarnitur Up&Down 1"1/4

Mitigeur bidet avec vidage Up&Down 1"1/4

RU 374 Senza scarico · Without waste · Ohne Ablaufgarnitur · Sans vidage

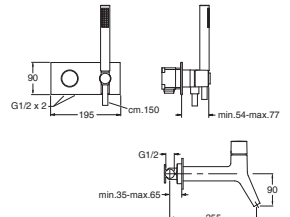
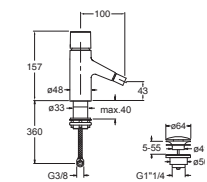

RU 100

Set completo per miscelatore monocomando vasca da incasso con flessibile LONG LIFE, piastra in metallo e doccetta anticalcare con miscelazione indipendente

Complete concealed bath mixer with LONG LIFE flexible hose, metal plate and anti-lime hand shower with independent mixing

Unterputz Wannen-Einhandmischer inkl. Einbaukörper mit Brauseschlauch LONG LIFE, Abdeckplatte aus Metall und Handbrause mit Antikalk-System und separater Mischung

Mitigeur bain douche encastré complet avec flexible LONG LIFE, plaque en métal et douchette anticalcaire avec mélange indépendant

**DOCCIA / SHOWER
BRAUSE / DOUCHE**

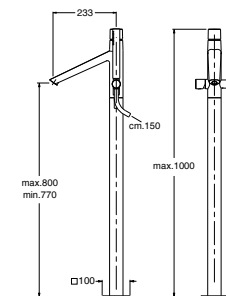

RU 190

Set da esterno per miscelatore monocomando vasca a pavimento CS 290 con flessibile LONG LIFE e doccetta anticalcare con miscelazione indipendente

Floor mounted bath mixer external parts for CS 290 with LONG LIFE flexible hose and anti-lime hand shower with independent mixing

Fertigmontageset Wannen-Einhandmischer bodenstehend für Einbaukörper CS 290 mit Brauseschlauch LONG LIFE und Handbrause mit Antikalk-System und unabhängiger Mischung

Façade externe mitigeur bain douche sur pied pour mécanisme CS 290 avec flexible LONG LIFE et douchette anticalcaire avec mélange indépendant



RU 689

Set da esterno per miscelatore monocomando doccia/vasca CS 535 con deviatore 2 uscite e piastra in metallo

Bath/shower mixer external parts for CS 535 with 2 outlet diverter and metal plate

Fertigmontageset Wannen/Brause-Einhandmischer für Einbaukörper CS 535 mit 2 Wege Umsteller und Abdeckplatte aus Metall

Façade externe pour mitigeur douche/bain douche 2 sorties pour mécanisme CS 535 avec plaque en métal

RU 689 Senza scarico · Without waste · Ohne Ablaufgarnitur · Sans vidage

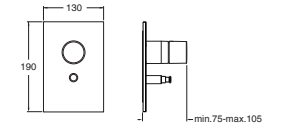



LAVABO / BASIN WASCHTISCH / LAVABO

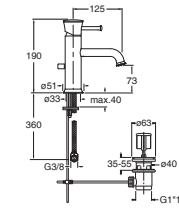

TO 221 REGULAR

Miscelatore monocomando REGULAR per lavabo con scarico 1"1/4 e asta comando

Basin mixer REGULAR with 1"1/4 pop up waste

Waschtisch-Einhandmischer REGULAR mit Ablaufgarnitur 1"1/4 und Zugstange

Mitigeur lavabo REGULAR avec vidage 1"1/4 à tirette

TO 920 Senza scarico · Without waste · Ohne Ablaufgarnitur · Sans vidage

Tricolore Retrò

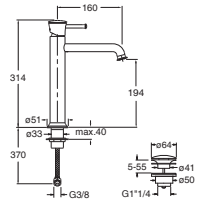

TO 227 MEDIUM

Miscelatore monocomando MEDIUM per lavabo con scarico Up&Down da 1"1/4

Basin mixer MEDIUM with 1"1/4 Up&Down waste

Waschtisch-Einhandmischer MEDIUM mit Ablaufgarnitur Up&Down 1"1/4

Mitigeur lavabo MEDIUM avec vidage Up&Down 1"1/4

TO 927 Senza scarico · Without waste · Ohne Ablaufgarnitur · Sans vidage

BIDET / BIDET

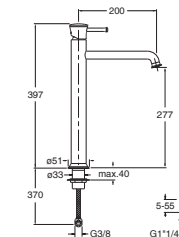

TO 222 TALL

Miscelatore monocomando TALL per lavabo con scarico Up&Down da 1"1/4

Basin mixer TALL with 1"1/4 Up&Down waste

Waschtisch-Einhandmischer TALL mit Ablaufgarnitur Up&Down 1"1/4

Mitigeur lavabo TALL avec vidage Up&Down 1"1/4

TO 922 Senza scarico · Without waste · Ohne Ablaufgarnitur · Sans vidage

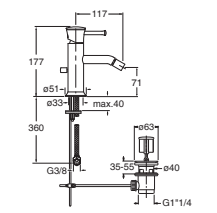

TO 321

Miscelatore monocomando per bidet con scarico 1"1/4 e asta comando

Bidet mixer with 1"1/4 pop up waste

Bidet-Einhandmischer mit Ablaufgarnitur 1"1/4 und Zugstange

Mitigeur bidet avec vidage 1"1/4 à tirette

TO 370 Senza scarico · Without waste · Ohne Ablaufgarnitur · Sans vidage

VASCA / BATH
WANNEN / BAIN DOUCHE

Tricolore Retrò

DOCCIA / SHOWER
BRAUSE / DOUCHE

Tricolore Retrò

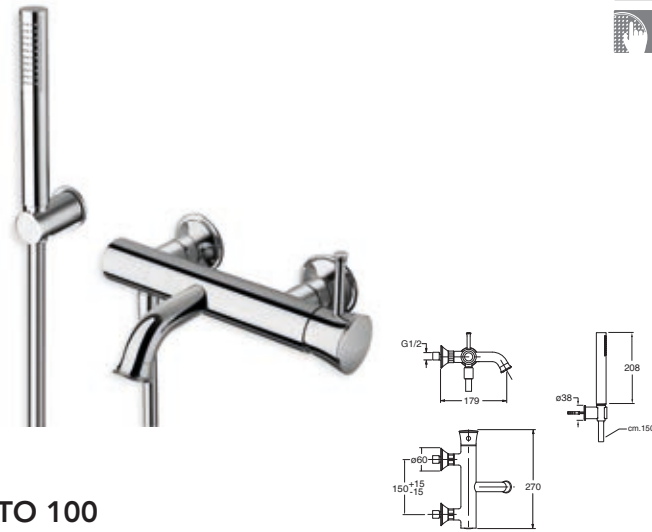

TO 100

Miscelatore monocomando per vasca esterno con flessibile LONG LIFE e doccetta anticalcare

External bath mixer with LONG LIFE flexible hose and anti-lime hand shower

Wannen-Einhandmischer Aufputz mit Brauseschlauch LONG LIFE und Handbrause mit Antikalk-System

Mitigeur bain douche extérieur avec flexible LONG LIFE et douchette anticalcaire



TO 101

Miscelatore monocomando per vasca esterno con flessibile LONG LIFE e doccetta anticalcare orientabile

External bath mixer with LONG LIFE flexible hose and adjustable anti-lime hand shower

Wannen-Einhandmischer Aufputz mit Brauseschlauch LONG LIFE, Handbrause mit Antikalk-System und verstellbarem Wandhalter

Mitigeur bain douche extérieur avec flexible LONG LIFE et douchette anticalcaire orientable



TO 686

Set da esterno per miscelatore monocomando doccia CS 535 con piastra in metallo

Fertigmontageset Brause-Einhandmischer für Einbaukörper CS 535 mit Abdeckplatte aus Metall

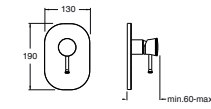

Shower mixer external parts for CS 535 with 1 outlet and metal plate

Façade externe pour mitigeur douche 1 sortie pour mécanisme CS 535 avec plaque en métal



TO 689

Set da esterno per miscelatore monocomando doccia/vasca CS 535 con deviatore 2 uscite e piastra in metallo

Fertigmontageset Wannen/Brause-Einhandmischer für Einbaukörper CS 535 mit 2 Wege Umsteller und Abdeckplatte aus Metall

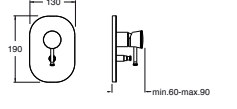

Bath/shower mixer external parts for CS 535 with 2 outlet diverter and metal plate

Façade externe pour mitigeur douche/bain douche 2 sorties pour mécanisme CS 535 avec plaque en métal



DOCCIA / SHOWER
BRAUSE / DOUCHE



TO 107

Miscelatore monocomando per vasca esterno

External bath mixer

Wannen-Einhandmischer Aufputz

Mitigeur bain douche extérieur



TO 401

Miscelatore monocomando per doccia esterno

External shower mixer

Brause-Einhandmischer Aufputz

Mitigeur douche extérieur





TV 221

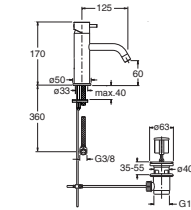

TV 221 REGULAR

Miscelatore monocomando REGULAR per lavabo con scarico 1"1/4 e asta comando

Basin mixer REGULAR with 1"1/4 pop up waste

Waschtisch-Einhandmischer REGULAR mit Ablaufgarnitur 1"1/4 und Zugstange

Mitigeur lavabo REGULAR avec vidage 1"1/4 à tirette

TV 920 Senza scarico · Without waste · Ohne Ablaufgarnitur · Sans vidage

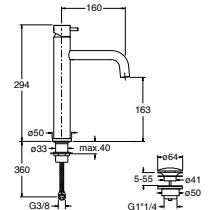

TV 227 MEDIUM

Miscelatore monocomando MEDIUM per lavabo con scarico Up&Down da 1"1/4

Basin mixer MEDIUM with 1"1/4 Up&Down waste

Waschtisch-Einhandmischer MEDIUM mit Ablaufgarnitur Up&Down 1"1/4

Mitigeur lavabo MEDIUM avec vidage Up&Down 1"1/4

TV 927 Senza scarico · Without waste · Ohne Ablaufgarnitur · Sans vidage

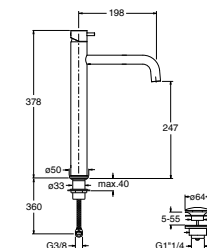

TV 222 TALL

Miscelatore monocomando TALL per lavabo con scarico Up&Down da 1"1/4

Basin mixer TALL with 1"1/4 Up&Down waste

Waschtisch-Einhandmischer TALL mit Ablaufgarnitur Up&Down 1"1/4

Mitigeur lavabo TALL avec vidage Up&Down 1"1/4

TV 922 Senza scarico · Without waste · Ohne Ablaufgarnitur · Sans vidage

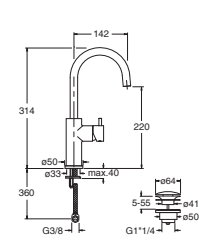

TV 226 REGULAR

Miscelatore monocomando REGULAR per lavabo con bocca girevole e scarico Up&Down da 1"1/4

Basin mixer REGULAR with swivel spout and 1"1/4 Up&Down waste

Waschtisch-Einhandmischer REGULAR mit Ablaufgarnitur Up&Down 1"1/4

Mitigeur lavabo REGULAR avec vidage Up&Down 1"1/4

TV 926 Senza scarico · Without waste · Ohne Ablaufgarnitur · Sans vidage

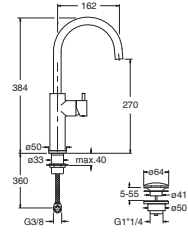

TV 229 MEDIUM

Miscelatore monocomando MEDIUM per lavabo con bocca girevole e scarico Up&Down da 1"1/4

Basin mixer MEDIUM with swivel spout and 1"1/4 Up&Down waste

Waschtisch-Einhandmischer MEDIUM mit Ablaufgarnitur Up&Down 1"1/4

Mitigeur lavabo MEDIUM avec vidage Up&Down 1"1/4

TV 929 Senza scarico · Without waste · Ohne Ablaufgarnitur · Sans vidage

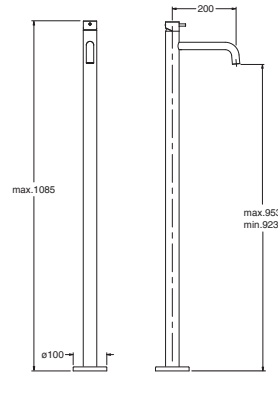

TV 290

Set da esterno per miscelatore monocomando lavabo a pavimento CS 290 con scarico Up&Down da 1"1/4

Floor mounted basin mixer external parts for CS 290 with 1"1/4 Up&Down waste

Fertigmontageset Waschtisch-Einhandmischer bodenstehend für Einbaukörper CS 290 mit Ablaufgarnitur Up&Down 1"1/4

Façade externe mitigeur lavabo sur pied pour mécanisme CS 290 avec vidage Up&Down 1"1/4

TV 990 Senza scarico · Without waste · Ohne Ablaufgarnitur · Sans vidage

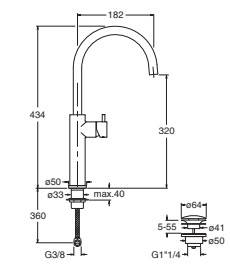

TV 249 TALL

Miscelatore monocomando TALL per lavabo con bocca girevole e scarico Up&Down da 1"1/4

Basin mixer TALL with swivel spout and 1"1/4 Up&Down waste

Waschtisch-Einhandmischer TALL mit Ablaufgarnitur Up&Down 1"1/4

Mitigeur lavabo TALL avec vidage Up&Down 1"1/4

TV 949 Senza scarico · Without waste · Ohne Ablaufgarnitur · Sans vidage



TV 224 REGULAR

Miscelatore monocomando per lavabo 2 fori con scarico Up&Down da 1"1/4

2 hole basin mixer with 1"1/4 Up&Down waste

2-Loch Waschtisch-Einhandmischer REGULAR mit Ablaufgarnitur Up&Down 1"1/4

Mitigeur lavabo 2 trous REGULAR avec vidage Up&Down 1"1/4

TV 924 Senza scarico · Without waste · Ohne Ablaufgarnitur · Sans vidage

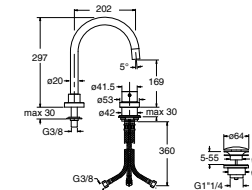

TV 277 REGULAR

Set da esterno per miscelatore monocomando lavabo REGULAR CS 237 - CS 238 con scarico Up&Down da 1"1/4

Wall mounted basin mixer REGULAR external parts for CS 237 - CS 238 with 1"1/4 Up&Down waste

Fertigmontageset Waschtisch-Einhandmischer REGULAR Wandmontage für Einbaukörper CS 237 - CS 238 mit Ablaufgarnitur Up&Down 1"1/4

Façade externe mitigeur lavabo encastré REGULAR pour mécanisme CS 237 - CS 238 avec vidage Up&Down 1"1/4

TV 977 Senza scarico · Without waste · Ohne Ablaufgarnitur · Sans vidage



TV 276 REGULAR

Set da esterno per miscelatore monocomando lavabo REGULAR CS 237 - CS 238 con scarico Up&Down da 1"1/4 e piastra in metallo

Wall mounted basin mixer REGULAR external parts for CS 237 - CS 238 with 1"1/4 Up&Down waste and metal plate

Fertigmontageset Waschtisch-Einhandmischer REGULAR Wandmontage für Einbaukörper CS 237 - CS 238 mit Ablaufgarnitur Up&Down 1"1/4 und Abdeckplatte aus Metall

Façade externe mitigeur lavabo encastré REGULAR pour mécanisme CS 237 - CS 238 avec vidage Up&Down 1"1/4 et plaque en métal

TV 976 Senza scarico · Without waste · Ohne Ablaufgarnitur · Sans vidage

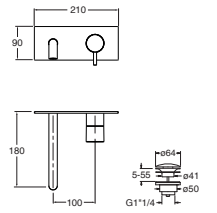

TV 265 REGULAR

Miscelatore monocomando REGULAR per lavabo con bocca incasso e scarico Up&Down da 1"1/4

Basin mixer REGULAR with wall mounted spout and 1"1/4 Up&Down waste

Waschtisch-Einhandmischer REGULAR mit Auslauf Wandmontage und Ablaufgarnitur Up&Down 1"1/4

Mitigeur lavabo REGULAR avec bec encastré et vidage Up&Down 1"1/4

TV 965 Senza scarico · Without waste · Ohne Ablaufgarnitur · Sans vidage

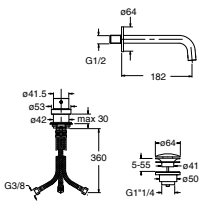



TV 321 REGULAR

Miscelatore monocomando per bidet con scarico 1"1/4 e asta comando

Bidet-Einhandmischer mit Ablaufgarnitur 1"1/4 und Zugstange

TV 370 Senza scarico · Without waste · Ohne Ablaufgarnitur · Sans vidage

Bidet mixer with 1"1/4 pop up waste

Mitigeur bidet avec vidage 1"1/4 à tirette

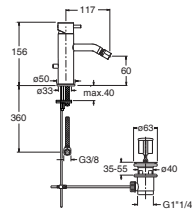

TV 326

Miscelatore monocomando per bidet con bocca girevole e scarico Up&Down da 1"1/4

Bidet-Einhandmischer mit Ablaufgarnitur Up&Down 1"1/4

TV 376 Senza scarico · Without waste · Ohne Ablaufgarnitur · Sans vidage

Bidet mixer with swivel spout and 1"1/4 Up&Down waste

Mitigeur bidet avec vidage Up&Down 1"1/4

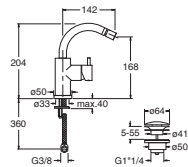

VASCA / BATH
WANNEN / BAIN DOUCHE



TV 180

Miscelatore monocomando per vasca esterno con flessibile LONG LIFE e doccetta anticalcare

Wannen-Einhandmischer Aufputz mit Brauseschlauch LONG LIFE und Handbrause mit Antikalk-System

External bath mixer with LONG LIFE flexible hose and anti-lime hand shower

Mitigeur bain douche extérieur avec flexible LONG LIFE et douchette anticalcaire

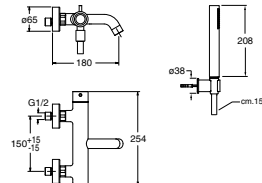

TV 108

Set da esterno per miscelatore monocomando doccia/vasca CS 137 con deviatore 2 uscite, doccetta anticalcare, flessibile LONG LIFE e piastra in metallo

Fertigmontageset Brause/Wannen-Einhandmischer für Einbaukörper CS 137 mit 2 Wege Umsteller, Handbrause mit Antikalk-System, Brauseschlauch LONG LIFE und Abdeckplatte aus Metall

Bath/shower mixer external parts for CS 137 with 2 outlet diverter, anti-lime hand shower, LONG LIFE flexible hose and metal plate

Façade externe mitigeur douche/bain douche encastré pour mécanisme CS 137 avec inverseur 2 sorties, douchette anticalcaire, flexible LONG LIFE et plaque en métal

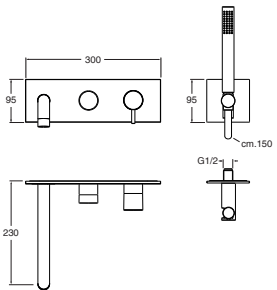

TV 189

Set da esterno per miscelatore monocomando vasca a pavimento CS 290 con flessibile LONG LIFE e doccetta anticalcare con miscelazione indipendente

Fertigmontageset Wannen-Einhandmischer bodenstehend für Einbaukörper CS 290 mit Brauseschlauch LONG LIFE und Handbrause mit Antikalk-System und separater Mischung

Floor mounted bath mixer external parts for CS 290 with LONG LIFE flexible hose and anti-lime hand shower with independent mixing

Façade externe mitigeur bain douche sur pied pour mécanisme CS 290 avec flexible LONG LIFE et douchette anticalcaire avec mélange indépendant

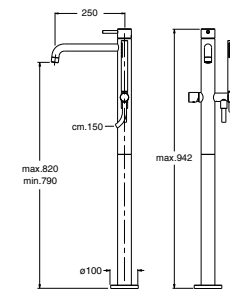

TV 121

Miscelatore monocomando per bordo vasca 2 fori con deviatore, doccetta anticalcare estraibile e FOLLOW ME

2-Loch Wannenrand-Einhandmischer mit Umsteller, herausziehbarer Handbrause mit Antikalk-System und FOLLOW ME - Funktion

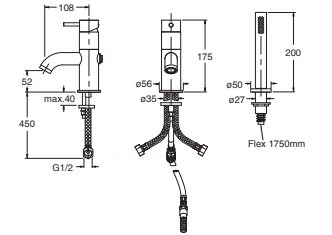

2 hole deck mounted bath mixer with diverter, pull-out anti-lime hand shower and FOLLOW ME

Mitigeur bain douche sur gorge 2 trous avec inverseur, douchette anticalcaire extractible et FOLLOW ME



XT 143

Miscelatore termostatico per bordo vasca con deviatore 3 uscite

Thermostat Wannenrandbatterie mit 3 Wege Umsteller

Deck mounted thermostatic bath mixer with 3 outlet diverter

Mitigeur thermostatique bain douche sur gorge avec inverseur 3 sorties

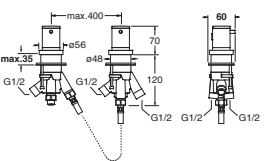

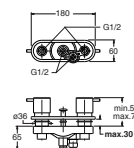

TV 133

Miscelatore bicomando per bordo vasca con deviatore 2 uscite e piastra in metallo

Deck mounted bath mixer with 2 outlet diverter and metal plate

Zweigriff-Wannenrandbatterie mit 2 Wege Umsteller und Abdeckplatte aus Metall

Mélangeur bain douche sur gorge avec inverseur 2 sorties et plaque en métal

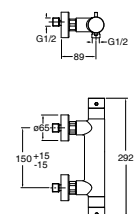

TV 451

Miscelatore termostatico per doccia esterno

External thermostatic shower mixer

Thermostat-Brausebatterie Aufputz

Mitigeur douche thermostatique extérieur

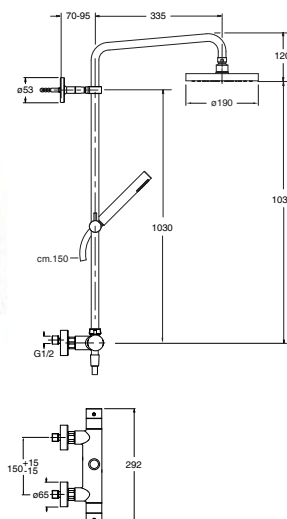

TV 486

Miscelatore termostatico per doccia esterno con colonna girevole, soffione anticalcare ispezionabile, doccetta anticalcare con supporto scorrevole e flessibile LONG LIFE

External thermostatic shower mixer with swivel column pipe, checkable anti-lime overhead shower, anti-lime hand shower with slide rail and LONG LIFE flexible hose

Thermostat-Brausebatterie Aufputz mit schwenkbarem Rohr, Kopfbrause mit Antikalk-System, Brauseschlauch LONG LIFE, Handbrause mit Antikalk-System und Gleitschieber

Colonne de douche orientable thermostatique avec pomme de douche anticalcaire démontable, douchette anticalcaire avec curseur réglable et flexible LONG LIFE

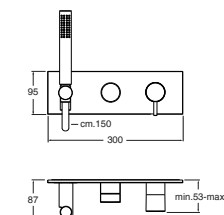

TV 608

Set da esterno per miscelatore monocomando doccia/vasca CS 137 con deviatore 2 uscite, doccetta anticalcare, flessibile LONG LIFE e piastra in metallo

Bath/shower mixer external parts for CS 137 with 2 outlet diverter, anti-lime hand shower, LONG LIFE flexible hose and metal plate

Fertigmontageset Brause/Wannen-Einhandmischer für Einbaukörper CS 137 mit 2 Wege Umsteller, Handbrause mit Antikalk-System, Brauseschlauch LONG LIFE und Abdeckplatte aus Metall

Façade externe mitigeur douche/bain douche encastré pour mécanisme CS 137 avec inverseur 2 sorties, douchette anticalcaire, flexible LONG LIFE et plaque en métal

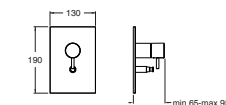

TV 689

Set da esterno per miscelatore monocomando doccia/vasca CS 535 con deviatore 2 uscite e piastra in metallo

Bath/shower mixer external parts for CS 535 with 2 outlet diverter and metal plate

Fertigmontageset Wannen/Brause-Einhandmischer für Einbaukörper CS 535 mit 2 Wege Umsteller und Abdeckplatte aus Metall

Façade externe pour mitigeur douche/bain douche 2 sorties pour mécanisme CS 535 avec plaque en métal





UC 222

LAVABO / BASIN
WASCHTISCH / LAVABO

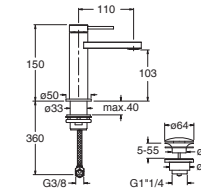

UC 220 REGULAR

Miscelatore monocomando REGULAR per lavabo con scarico Up&Down da 1"1/4

Waschtisch-Einhandmischer REGULAR mit Ablaufgarnitur Up&Down 1"1/4

Basin mixer REGULAR with 1"1/4 Up&Down waste

Mitigeur lavabo REGULAR avec vidage Up&Down 1"1/4

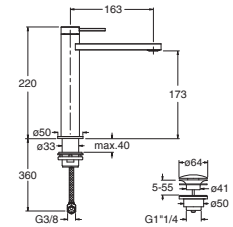

UC 227 MEDIUM

Miscelatore monocomando MEDIUM per lavabo con scarico Up&Down da 1"1/4

Waschtisch-Einhandmischer MEDIUM mit Ablaufgarnitur Up&Down 1"1/4

Basin mixer MEDIUM with 1"1/4 Up&Down waste

Mitigeur lavabo MEDIUM avec vidage Up&Down 1"1/4

UC 920 Senza scarico · Without waste · Ohne Ablaufgarnitur · Sans vidage

UC 927 Senza scarico · Without waste · Ohne Ablaufgarnitur · Sans vidage

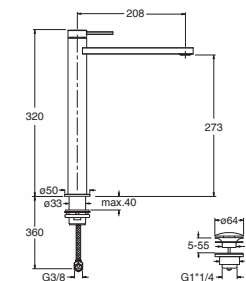

UC 222 TALL

Miscelatore monocomando TALL per lavabo con scarico Up&Down da 1"1/4

Waschtisch-Einhandmischer TALL mit Ablaufgarnitur Up&Down 1"1/4

Basin mixer TALL with 1"1/4 Up&Down waste

Mitigeur lavabo TALL avec vidage Up&Down 1"1/4

UC 922 Senza scarico · Without waste · Ohne Ablaufgarnitur · Sans vidage

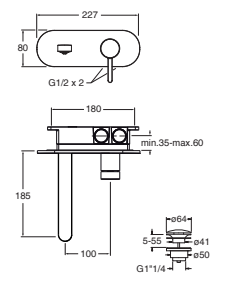

UC 276 REGULAR

Set completo per miscelatore monocomando lavabo REGULAR da incasso destro con scarico Up&Down da 1"1/4

Unterputz-Waschtisch-Einhandmischer REGULAR (rechts) Wandmontage inkl. Einbaukörper mit Ablaufgarnitur Up&Down 1"1/4 und Abdeckplatte aus Metall

Complete wall mounted basin mixer REGULAR with 1"1/4 Up&Down waste - right side

Mitigeur droite lavabo encastré REGULAR complet avec vidage Up&Down 1"1/4 et plaque en métal

UC 976 Senza scarico · Without waste · Ohne Ablaufgarnitur · Sans vidage

LAVABO / BASIN
WASCHTISCH / LAVABO

BIDET / BIDET

UniC

DOCCIA / SHOWER
BRAUSE / DOUCHE

UniC

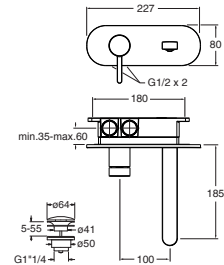

UC 277 REGULAR

Set completo per miscelatore monocomando lavabo REGULAR da incasso sinistro con scarico Up&Down da 1"1/4

Complete wall mounted basin mixer REGULAR with 1"1/4 Up&Down waste left side

Unterputz-Waschtisch-Einhandmischer REGULAR (links) Wandmontage inkl. Einbaukörper mit Ablaufgarnitur Up&Down 1"1/4 und Abdeckplatte aus Metall

Mitigeur gauche lavabo encastré complet REGULAR avec vidage Up&Down 1"1/4 et plaque en métal

UC 977 Senza scarico · Without waste · Ohne Ablaufgarnitur · Sans vidage

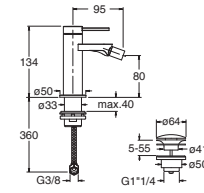

UC 320

Miscelatore monocomando per bidet con scarico Up&Down da 1"1/4

Bidet mixer with 1"1/4 Up&Down waste

Bidet-Einhandmischer mit Ablaufgarnitur Up&Down 1"1/4

Mitigeur bidet avec vidage Up&Down 1"1/4

UC 370 Senza scarico · Without waste · Ohne Ablaufgarnitur · Sans vidage

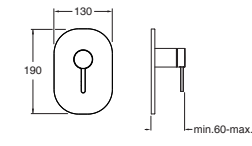

UC 686

Set da esterno per miscelatore monocomando doccia CS 535 con piastra in metallo

Shower mixer external parts for CS 535 with 1 outlet and metal plate

Fertigmontageset Brause-Einhandmischer für Einbaukörper CS 535 mit Abdeckplatte aus Metall

Façade externe pour mitigeur douche 1 sortie pour mécanisme CS 535 avec plaque en métal

UC 686 Senza scarico · Without waste · Ohne Ablaufgarnitur · Sans vidage

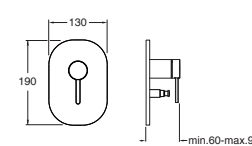

UC 689

Set da esterno per miscelatore monocomando doccia/vasca CS 535 con deviatore 2 uscite e piastra in metallo

Bath/shower mixer external parts for CS 535 with 2 outlet diverter and metal plate

Fertigmontageset Wannen/Brause-Einhandmischer für Einbaukörper CS 535 mit 2 Wege Umsteller und Abdeckplatte aus Metall

Façade externe pour mitigeur douche/bain douche 2 sorties pour mécanisme CS 535 avec plaque en métal

UC 689 Senza scarico · Without waste · Ohne Ablaufgarnitur · Sans vidage

VASCA / BATH
WANNEN / BAIN DOUCHE

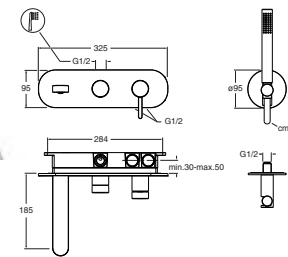

UC 108

Set completo per miscelatore monocomando doccia/vasca da incasso con deviatore 2 uscite, doccetta anticalcare in ottone, flessibile LONG LIFE e piastra in metallo

Complete concealed bath/shower mixer with 2 outlet diverter, brass anti-lime hand shower, LONG LIFE flexible hose and metal plate

Unterputz Brause/Wannen-Einhandmischer inkl. Einbaukörper mit 2 Wege Umsteller, Handbrause aus Messing mit Antikalk-System, Brauseschlauch LONG LIFE und Abdeckplatte aus Metall

Mitigeur douche/bain douche encastré complet avec inverseur 2 sorties, douchette anticalcaire en laiton, flexible LONG LIFE et plaque en métal

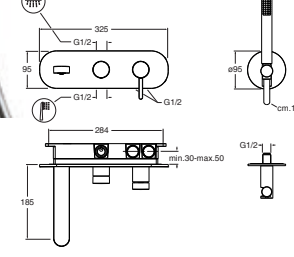

UC 110

Set completo per miscelatore monocomando doccia/vasca da incasso con deviatore 3 uscite, doccetta anticalcare in ottone, flessibile LONG LIFE e piastra in metallo

Complete concealed bath/shower mixer with 3 outlet diverter, brass anti-lime hand shower, LONG LIFE flexible hose and metal plate

Unterputz Brause/Wannen-Einhandmischer inkl. Einbaukörper mit 3 Wege Umsteller, Handbrause aus Messing mit Antikalk-System, Brauseschlauch LONG LIFE und Abdeckplatte aus Metall

Mitigeur douche/bain douche encastré complet avec inverseur 3 sorties, douchette anticalcaire en laiton, flexible LONG LIFE et plaque en métal

UC 110 Senza scarico · Without waste · Ohne Ablaufgarnitur · Sans vidage



UC 108