



# BAMBU'

EQB DESIGN



BAMBU'



TABELLA PREZZI FINITURE	pag. 464
INFO TECNICHE	pag. 464
INDICE / INDEX	pag. 466
LAVABO	pag. 472
BIDET	pag. 479
DOCCIA INCASSO	pag. 480
DEVIATORI INCASSO	pag. 481
DOCCIA ESTERNO	pag. 481
DOCCIA ESTERNO THERMOSTATICO	pag. 482
VASCA	pag. 483
BAGNO COMPLEMENTI	pag. 485

**PREZZO FINITURE**

Calcola il prezzo di listino (IVA esclusa) delle finiture diverse dal cromato, consultando la seguente tabella.

Moltiplicare il **PREZZO LISTINO** per il **COEFFICIENTE MOLTIPLICATORE** della finitura scelta, arrotondando per difetto il prezzo ottenuto (eliminare i centesimi).  
**ESEMPIO** per ordinare art. 0405/N in finitura dorato: codice 04-0405/N

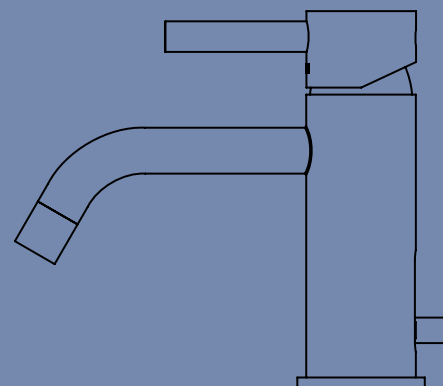
**PRICE FINISHES**

Include the list price (excluding VAT) of different finishes from chrome, consulting the following table. **Multiply the PRICE LIST MULTIPLIER COEFFICIENT** of the chosen finish, reducing the price obtained by deleting the centesim.

**EXAMPLE** to order art. 0405/N gold finish: code 04-0405/N

**FINITURE DI SERIE / STANDARD FINISHES**

CODICE CODE	DESCRIZIONE FINITURA FINISH DESCRIPTION	MOLTIPLICATORE MULTIPLIER
01-	cromato / chrome	PREZZO LISTINO*
33-	cromo satinato / satin chrome	x
34-	cromo spazzolato / brushing chrome	x
35-	nickel spazzolato / brushing nickel	x
66-	bianco opaco / mat white	x
67-	nero opaco / mat black	x
69-	argento opaco / mat silver	x
75-	dorato spazzolato / brushing gold	x

**FINITURE A RICHIESTA / ON REQUEST FINISHES**

CODICE CODE	DESCRIZIONE FINITURA FINISH DESCRIPTION	MOLTIPLICATORE MULTIPLIER
02-	cromo/oro / chrome/gold	x
03-	oro/argento / gold/silver	x
04-	dorato / gold	x
05-	bronzo satinato / satin bronze	x
06-	rame vecchio / old copper	x
07-	vecchio argento / old silver	x
08-	canna di fucile / gun barrel	x
10-	verderame / verdigris	x

**COMPOSIZIONE CODICE PER ORDINARE ARTICOLO IN FINITURA**



CODICE FINITURA  
FINISH CODE

CODICE ARTICOLO  
ITEM NUMBER

**FINITURE A RICHIESTA / ON REQUEST FINISHES**

CODICE CODE	DESCRIZIONE FINITURA FINISH DESCRIPTION	MOLTIPLICATORE MULTIPLIER
11-	nero antracite / anthracite black	x
12-	ottone lucido / polished brass	x
13-	ottone naturale / natural brass	x
14-	bianco / white	x
19-	nero / black	x
28-	nickel satinato / satin nickel	x
30-	nickel lucido / polished nickel	x
56-	avorio / ivory	x
57-	azzurro / light blue	x
58-	verdino / light green	x
59-	marrone / brown	x
60-	arancio / orange	x
61-	rosso / red	x
68-	rame opaco / mat copper	x
71-	oro opaco / mat gold	x
72-	bronzo opaco / mat bronze	x
87-	oro rosa / pink gold	x
88-	ottone sisal / sisal brass	x

\*PREZZO DI LISTINO / PRICE LIST

\*NON REALIZZABILE / NOT MADE

**ATTENZIONE! 13-OTTONE NATURALE e 88-OTTONE SISAL: finiture non protette che antichizzano naturalmente ossidando a contatto con l'umidità atmosferica.**  
**WARNING! 13-NATURAL BRASS and 88-SISAL BRASS: unprotected finishes that naturally oxidise in contact with atmospheric humidity.**

**PROGETTO SU MISURA: RICHIESTE SPECIALI**

I tecnici di Bellosta Rubinetterie sono, inoltre, a disposizione di architetti e designers, per offrire un servizio esclusivo: personalizzazioni di elementi in funzione di specifiche richieste estetiche o problematiche legate a vincoli progettuali, verifica della fattibilità attraverso opportuni studi CAD e sviluppo del disegno tecnico del prodotto speciale richiesto.

Per informazioni e richieste PROGETTI SU MISURA:  
 ufficiotecnico@bellostarubinetterie.com



**PROGETTO SU MISURA: SPECIAL REQUESTS**

Engineers Bellosta Rubinetterie are also available to architects and designers, to offer an exclusive service: customizations of items according to specific aesthetic requirements or issues related to design constraints, verification of the feasibility studies and development through appropriate CAD technical design the required special product. For information and requests "SU MISURA" PROJECTS:  
 ufficiotecnico@bellostarubinetterie.com

**CONSIGLIO TECNICO**

Tutti i miscelatori della collezione BAMBU' vengono collaudati nel loro funzionamento al momento dell'assemblaggio. Per garantire la durata delle cartucce nel tempo, si consiglia di spurgare bene l'impianto idraulico prima del montaggio (per rimuovere eventuali detriti) e di installare rubinetti sottolavabo con filtro (art. 020 o 020/1)

N.B.: Qualora il piano lavabo avesse uno spessore superiore a 2,5 cm specificare la misura al momento dell'ordine.

**TECHNICAL ADVICE**

All mixers of the BAMBU' collection are perfectly tested. To guarantee the perfect functionality of the cartridge for a long time, we advise to clean the sanitary plant before installing the mixer. Moreover we advise to install angle valve with filter (art. 020 or 020/1).

Attention: If the lavatory top is more than cm 2,5 hick, please point it out when placing the order.

**FORATURA DEI PIANI SANITARI**

I miscelatori lavabo/bidet monoforo prevedono un foro di diametro 35 mm nel piano sanitario.

MONOFORO >>

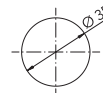

**DRILLING PLANS HEALTH**

The sink / hole bidet mixers provide a hole diameter of 35 mm in the health plan.

**SCHEMA FUNZIONAMENTO DEVIATORI INCASSO 2/3/4 USCITE**

Questi deviatori non hanno funzione di chiusura. Ruotando verso destra o sinistra si attivano le uscite. Tra 2 uscite adiacenti durante la rotazione diminuisce la portata dell'uscita iniziale ed incrementa quella della successiva. In posizione intermedia sono entrambe attive a pari portata.

**SCHEME OPERATION SWITCHES FLUSH OUTPUT 2/3/4**

These diverters have not closing function. By turning to the right or left activates the outputs. Between two adjacent outputs during the rotation decreases the initial output flow and increases that of the next. In position intermediate are both active at the same flow rate.

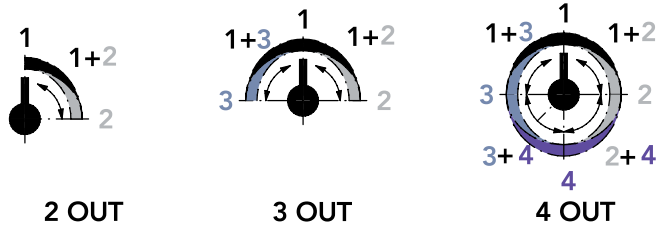





**LEGENDA SIMBOLI**



**ACCESSORI  
ACCESSORIES**

-  SCARICO C/TAPPO A PRESSIONE
- WASTE WITH PRESSURE CAP

**RICAMBI IMMEDIATI  
IMMEDIATE PARTS**

-  CARTUCCIA CARTRIDGE
-  CARTUCCIA DEVIATRICE DIVERTER CARTRIDGE

-  CARTUCCIA TERMOSTATICA THERMOSTATIC CARTRIDGE
-  DEVIATORE DIVERTER

-  VITONE CERAMICO CERAMIC VALVE
-  AERATORE TONDO ROUND AERATOR

-  VITONE TRADIZIONALE TRADITIONAL VALVE
-  AERATORE PIATTO FLAT AERATOR

LAVABO



**0405/N** pag. 472  
 MISCELATORE LAVABO MONOFORO  
 BASIN MIXER



**0405/N/S** pag. 472  
 MISCELATORE LAVABO MONOFORO  
 BASIN MIXER



**0405/NP** pag. 472  
 MISCELATORE LAVABO MONOFORO BOCCA  
 PROLUNGATA  
 BASIN MIXER WITH EXTENDED SPOUT



**0405/NP/S** pag. 472  
 MISCELATORE LAVABO MONOFORO BOCCA  
 PROLUNGATA  
 BASIN MIXER WITH EXTENDED SPOUT



**0405/NPA** pag. 472  
 MISCELATORE LAVABO MONOFORO BOCCA  
 EXTRAPROLUNGATA  
 BASIN MIXER WITH EXTRA EXTENDED SPOUT



**0405/NPA/S** pag. 473  
 MISCELATORE LAVABO MONOFORO BOCCA  
 EXTRAPROLUNGATA  
 BASIN MIXER WITH EXTRA EXTENDED SPOUT



**044026, 044027, 044028** pag. 473  
 PROLUNGHE MISCELATORE LAVABO  
 EXTENSIONS BASIN MIXER



altezza mm 100 / high 50 mm: 044026  
 altezza mm 100 / high 100 mm: 044027  
 altezza mm 150 / high 150 mm: 044028

**0405/4/A** pag. 473  
 MISCELATORE LAVABO MONOFORO BOCCA  
 GIREVOLE  
 BASIN MIXER SWINGING SPOUT



**0405/4/B** pag. 473  
 MISCELATORE LAVABO MONOFORO BOCCA  
 GIREVOLE PROLUNGATA  
 BASIN MIXER SWINGING SPOUT



**0405/4/C** pag. 473  
 MISCELATORE LAVABO MONOFORO BOCCA  
 GIREVOLE EXTRAPROLUNGATA  
 BASIN MIXER EXTENDED SWINGING SPOUT



**0405/4/A/J** pag. 474  
 MISCELATORE LAVABO MONOFORO BOCCA  
 GIREVOLE JUST  
 BASIN MIXER "JUST" SWINGING SPOUT



**044029, 044030, 044031** pag. 474  
 PROLUNGHE MISCELATORE LAVABO  
 EXTENSIONS BASIN MIXER



altezza mm 50 / high 50 mm: 044029  
 altezza mm 100 / high 100 mm: 044030  
 altezza mm 150 / high 150 mm: 044031

**0405/3/A/E + 104033** pag. 474  
 MISCELATORE LAVABO DA PARETE  
 WALL BASIN MIXER



parti esterne / external parts: 0405/3/A/E  
 parte incasso / built-in part: 104033



**0405/3/B/E + 104033** pag. 474  
 MISCELATORE LAVABO DA PARETE BOCCA  
 PROLUNGATA  
 WALL BASIN MIXER EXTENDED SPOUT



parti esterne / external parts: 0405/3/B/E  
 parte incasso / built-in part: 104033



**0405/3/C/E + 104033** pag. 474  
 MISCELATORE LAVABO DA PARETE BOCCA  
 EXTRAPROLUNGATA  
 WALL BASIN MIXER EXTRA EXTENDED SPOUT



parti esterne / external parts: 0405/3/C/E  
 parte incasso / built-in part: 104033



**0405/3/AV/E + 104033** pag. 475  
 MISCELATORE LAVABO DA PARETE BOCCA 90°  
 WALL BASIN MIXER 90° SPOUT



parti esterne / external parts: 0405/3/AV/E  
 parte incasso / built-in part: 104033



LAVABO

**NEW** **0405/3/BV/E + 104033** pag. 475

MISCELATORE LAVABO DA PARETE BOCCA 90°  
PROLUNGATA  
WALL BASIN MIXER EXTENDED SPOUT 90°



parti esterne / external parts: 0405/3/BV/E  
parte incasso / built-in part: 104033

**NEW** **0405/3/CV/E + 104033** pag. 475

MISCELATORE LAVABO DA PARETE BOCCA 90°  
EXTRAPROLUNGATA  
WALL BASIN MIXER EXTRA EXTENDED SPOUT 90°



parti esterne / external parts: 0405/3/CV/E  
parte incasso / built-in part: 104033

**0405/3/1/E + 894001** pag. 475

MISCELATORE LAVABO DA PARETE SU PIASTRA  
WALL BASIN MIXER ON PLATE



parti esterne / external parts: 0405/3/1/E  
parte incasso / built-in part: 894001

**0405/3/2/E + 894001** pag. 475

MISCELATORE LAVABO DA PARETE BOCCA  
PROLUNGATA SU PIASTRA  
WALL BASIN MIXER EXTENDED SPOUT ON PLATE



parti esterne / external parts: 0405/3/2/E  
parte incasso / built-in part: 894001

**0405/3/3/E + 894001** pag. 476

MISCELATORE LAVABO DA PARETE BOCCA  
EXTRAPROL SU PIASTRA  
WALL BASIN MIXER EXTRA EXTENDED SPOUT ON  
PLATE



parti esterne / external parts: 0405/3/3/E  
parte incasso / built-in part: 894001

**NEW** **0405/3/1V/E + 894001** pag. 476

MISCELATORE LAVABO DA PARETE BOCCA 90° SU  
PIASTRA  
WALL BASIN MIXER 90° SPOUT ON PLATE



parti esterne / external parts: 0405/3/1V/E  
parte incasso / built-in part: 894001

**NEW** **0405/3/2V/E + 894001** pag. 476

MISCELATORE LAVABO DA PARETE BOCCA 90°  
PROLUNGATA SU PIASTRA  
WALL BASIN MIXER EXTENDED SPOUT 90° ON  
PLATE



parti esterne / external parts: 0405/3/2V/E  
parte incasso / built-in part: 894001

**NEW** **0405/3/3V/E + 894001** pag. 476

MISCELATORE LAVABO DA PARETE BOCCA 90°  
EXTRAPROLUNGATA SU PIASTRA  
WALL BASIN MIXER EXTRA EXTENDED SPOUT 90°  
ON PLATE



parti esterne / external parts: 0405/3/3V/E  
parte incasso / built-in part: 894001

**0405/PT/E + 734012** pag. 476

MISCELATORE LAVABO C/ATTACCHI A PAVIMENTO  
BASIN MIXER FLOOR CONNECTION



parti esterne / external parts: 0405/PT/E  
parte incasso / built-in part: 734012

**0405/PAT/E + 734012** pag. 477

MISCELATORE LAVABO C/ATTACCHI A PAVIMENTO  
BASIN MIXER FLOOR CONNECTION



parti esterne / external parts: 0405/PAT/E  
parte incasso / built-in part: 734012

**0410/BT/E + 734012** pag. 477

MISCELATORE LAVABO C/ATTACCHI A PAVIMENTO  
BOCCA GIREVOLE  
BASIN MIXER SWINGING SPOUT FLOOR  
CONNECTION



parti esterne / external parts: 0410/BT/E  
parte incasso / built-in part: 734012

**0410/CT/E + 734012** pag. 477

MISCELATORE LAVABO C/ATTACCHI A PAVIMENTO  
BOCCA GIREVOLE PROLUNGATA  
BASIN MIXER EXTENDED SWINGING SPOUT FLOOR  
CONNECTION



parti esterne / external parts: 0410/CT/E  
parte incasso / built-in part: 734012

**0410/JT/E + 734012** pag. 477

MISCELATORE LAVABO C/ATTACCHI A PAVIMENTO  
BOCCA JUST GIREVOLE  
BASIN MIXER SWINGING "JUST" SPOUT FLOOR  
CONNECTION



parti esterne / external parts: 0410/JT/E  
parte incasso / built-in part: 734012

**0405/R/A** pag. 477

MISCELATORE REMOTO  
REMOTE MIXER



**0405/R/B/E + 104033** pag. 478

MISCELATORE INCASSO REMOTO  
BUILT-IN REMOTE MIXER



parti esterne / external parts: 0405/R/B/E  
parte incasso / built-in part: 104033

**0405/R/BQ/E** pag. 478

MISCELATORE INCASSO REMOTO  
BUILT-IN REMOTE MIXER



parti esterne / external parts: 0405/R/BQ/E  
parte incasso / built-in part: 104033



LAVABO



**0405/1/A** pag. 478  
BOCCA LAVABO  
WASH SPOUT



**0405/1/A/J** pag. 478  
BOCCA LAVABO JUST  
"JUST" WASH SPOUT



**0405/1/B** pag. 478  
BOCCA LAVABO MEDIUM  
"MEDIUM" WASH SPOUT



**0405/1/B/J** pag. 479  
BOCCA LAVABO JUST MEDIUM  
" MEDIUM JUST" WASH SPOUT



**0405/1/C** pag. 479  
BOCCA LAVABO ALTA  
HIGH WASH SPOUT



**0405/1/C/J** pag. 479  
BOCCA LAVABO JUST ALTA  
HIGH "JUST" WASH SPOUT



**0405/26** pag. 479  
BOCCA LAVABO CON ATTACCO A PAVIMENTO  
WASH SPOUT FLOOR CONNECTION

BIDET



**0407/N** pag. 479  
MISCELATORE BIDET MONOFORO  
BIDET MIXER



**0407/2** pag. 480  
MISCELATORE BIDET MONOFORO LEVA LAT  
BOCCA GIREVOLE  
BIDET MIXER SWINGING SPOUT SIDE LEVER

DOCCIA INCASSO



**0421/N/E + 104018** pag. 480  
MISCELATORE INCASSO  
BUILT-IN MIXER



**0421/Q/E + 104018** pag. 480  
MISCELATORE INCASSO  
BUILT-IN MIXER



parti esterne / external parts: 0421/N/E  
parte incasso / built-in part: 104018



parti esterne / external parts: 0421/Q/E  
parte incasso / built-in part: 104018



**0400/E + 104002** pag. 480  
MISCELATORE INCASSO C/DEVIATORE 2 USCITE  
BUILT-IN MIXER WITH DIVERTER 2 OUT



**0400/Q/E + 104002** pag. 480  
MISCELATORE INCASSO C/DEVIATORE 2 USCITE  
BUILT-IN MIXER WITH DIVERTER 2 OUT



parti esterne / external parts: 0400/E  
parte incasso / built-in part: 104002



parti esterne / external parts: 0400/Q/E  
parte incasso / built-in part: 104002

DEVIATORI INCASSO



**0403/2/1N/E + 914016** pag. 481  
DEVIATORE INCASSO 2 USCITE  
BUILT-IN DIVERTER 2 OUT



**0403/3/1N/E + 034127** pag. 481  
DEVIATORE INCASSO 3 USCITE  
BUILT-IN DIVERTER 3 OUT



parti esterne / external parts: 0403/2/1N/E  
parte incasso / built-in part: 914016



parti esterne / external parts: 0403/3/1N/E  
parte incasso / built-in part: 034127

**DOCCIA INCASSO TERMOSTATICO**



**0403/4/1N/E + 034128** pag. 481

DEVIATORE INCASSO 4 USCITE  
BUILT-IN DIVERTER 4 OUT



parti esterne / external parts: 0403/4/1N/E  
parte incasso / built-in part: 034128

**DOCCIA INCASSO TERMOSTATICO**



**8812/H/P/E + 484020** pag. 192\*

MISCELATORE TERMOSTATICO INCASSO 1 USCITA  
BUILT-IN THERMOSTATIC MIXER 1 OUT



parti esterne / external parts: 8812/H/P/E  
parte incasso / built-in part: 484020



**8812/2/P/E + 484021** pag. 192\*

MISCELATORE TERMOSTATICO INCASSO  
C/DEVIATORE 2 USCITE  
BUILT-IN THERMOSTATIC MIXER WITH DIVERTER  
2 OUT



parti esterne / external parts: 8812/2/P/E  
parte incasso / built-in part: 484021



**8812/3/P/E + 484022** pag. 192\*

MISCELATORE TERMOSTATICO INCASSO  
C/DEVIATORE 3 USCITE  
BUILT-IN THERMOSTATIC MIXER WITH DIVERTER  
3 OUT



parti esterne / external parts: 8812/3/P/E  
parte incasso / built-in part: 484022



**8812/4/P/E + 484023** pag. 192\*

MISCELATORE TERMOSTATICO INCASSO  
C/DEVIATORE 4 USCITE  
BUILT-IN THERMOSTATIC MIXER WITH DIVERTER  
4 OUT



parti esterne / external parts: 8812/4/P/E  
parte incasso / built-in part: 484023

**DOCCIA ESTERNO**



**0409/1** pag. 481

MISCELATORE DOCCIA ESTERNO  
EXTERNAL SHOWER MIXER



**0409/4/SP** pag. 482

MISCELATORE DOCCIA ESTERNO C/STELO  
EXTERNAL SHOWER MIXER WITH PIPE



**0409/5/1/SP** pag. 482

MISCELATORE DOCCIA ESTERNO C/STELO  
COMPLETO  
EXTERNAL SHOWER MIXER WITH COMPLETE PIPE

**DOCCIA ESTERNO TERMOSTATICO**



**0411/1A** pag. 482

MISCELATORE DOCCIA ESTERNO TERMOSTATICO  
EXTERNAL THERMOSTATIC MIXER



**0411/4A** pag. 482

MISCELATORE DOCCIA ESTERNO TERMOSTATICO  
C/STELO  
EXTERNAL THERMOSTATIC MIXER WITH PIPE



**0411/5A** pag. 482

MISCELATORE DOCCIA ESTERNO TERMOSTATICO  
C/STELO COMPLETO  
EXTERNAL THERMOSTATIC MIXER WITH COMPLETE  
PIPE

**DOCCIA COMPLEMENTI**



**4403/1/A** pag. 134\*

SUPPORTO DOCCIA COMPLETO  
FULL SHOWER SUPPORT



**4403/1** pag. 135\*

SUPPORTO DOCCIA DUPLEX COMPLETO  
FULL SHOWER SUPPORT WITH DUPLEX

\* ABBINAMENTO CONSIGLIATO: PER PREZZI E SCHEDE TECNICHE, VEDI RIFERIMENTO PAGINA LISTINO REVIVRE

\* RECOMMENDED COMBINATION: FOR PRICES AND TECHNICAL DETAILS, LOOK AT PAGE WITH REFERENCE REVIVRE PRICE

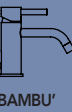



**DOCCIA COMPLEMENTI**



**0403/1/C** pag. 132\*  
 SUPPORTO DOCCIA COMPLETO  
 FULL SHOWER SUPPORT



**0403/1/B** pag. 132\*  
 SUPPORTO DOCCIA DUPLEX COMPLETO  
 FULL SHOWER SUPPORT WITH DUPLEX



**0530** pag. 140\*  
 SALISCENDI COMPLETO C/PRESA D'ACQUA  
 COMPLETE WALL PIPE WITH WATER CONNECTION



**0530/1** pag. 145\*  
 ASTA SALISCENDI  
 WALL PIPE



**0413/4/SP** pag. 149\*  
 STELO DOCCIA  
 ROD SHOWER



**0413/5/1/SP** pag. 150\*  
 CURVA PRESA ACQUA C/STELO COMPLETO  
 CURVE WATER CONNECTOR WITH COMPLETE ROD



**0514** pag. 153\*  
 CESTINO PORTA SAPONE  
 SOAP BASKET

**VASCA**



**0401/A** pag. 483  
 MISCELATORE VASCA ESTERNO  
 EXTERNAL BATH MIXER



**0401/2/A** pag. 483  
 MISCELATORE PER BORDO VASCA  
 BATH RIM MIXER



**0401/2/J/A** pag. 483  
 MISCELATORE PER BORDO VASCA BOCCA "JUST"  
 BATH RIM MIXER "JUST" SPOUT



**0401/2/P/A** pag. 483  
 MISCELATORE PER BORDO VASCA C/PIASTRA  
 BATH RIM MIXER ON PLATE



**0401/2/J/P/A** pag. 483  
 MISCELATORE PER BORDO VASCA C/PIASTRA  
 BOCCA "JUST"  
 BATH RIM MIXER ON PLATE "JUST" SPOUT



**0401/20/A** pag. 484  
 MISCELATORE PER BORDO VASCA S/BOCCA  
 BATH RIM MIXER WITHOUT SPOUT



**0401/20/P/A** pag. 484  
 MISCELATORE PER BORDO VASCA C/PIASTRA S/  
 BOCCA  
 BATH RIM MIXER WITHOUT SPOUT ON PLATE



**0401/4/AE + 734012** pag. 484  
 MISCELATORE VASCA C/ATTACCO A PAVIMENTO  
 BATH MIXER WITH FLOOR CONNECTION

parti esterne / external parts: 0401/4/AE  
 parte incasso / built-in part: 734012

## VASCA



0401/4/JAE + 734012 pag. 484

MISCELATORE VASCA C/ATTACCO A PAVIMENTO  
BOCCA JUST  
BATH MIXER "JUST" SPOUT WITH FLOOR  
CONNECTION

parti esterne / external parts: 0401/4/JAE  
parte incasso / built-in part: 734012



0103 pag. 484

BOCCA VASCA DA PARETE  
WALL BATH SPOUT



0401/26 pag. 485

BOCCA VASCA DA PAVIMENTO  
BATH SPOUT FLOOR CONNECTION



0401/26/J pag. 485

BOCCA VASCA DA PAVIMENTO BOCCA "JUST"  
BATH SPOUT FLOOR CONNECTION "JUST" SPOUT

## COMPLEMENTI BAGNO



0408/E + 054025 o 054026 pag. 485

RUBINETTO D'ARRESTO 1/2"  
BUILT-IN STOP COCK 1/2"



parti esterne / external parts: 0408/E  
parte incasso / built-in part: 054025 DX o 054025 SX



0408/E + 054027 o 054028 pag. 485

RUBINETTO D'ARRESTO 3/4"  
BUILT-IN STOP COCK 3/4"



parti esterne / external parts: 0408/E  
parte incasso / built-in part: 054027 DX o 054028 SX



0440/E + 884053 pag. 485

PASSO RAPIDO 3/4"  
BUILT-IN RAPID FLOW COCK 3/4"



parti esterne / external parts: 0440/E  
parte incasso / built-in part: 884053



0440/E + 884054 pag. 486

PASSO RAPIDO 1"  
BUILT-IN RAPID FLOW COCK 1"



parti esterne / external parts: 0440/E  
parte incasso / built-in part: 884054



0432/2/E + 035212 pag. 486

SARACINESCA  
GATE VALVE



parti esterne / external parts: 0432/2/E  
parte incasso / built-in part: 035212

## B-TRONIC - RUBINETTI ELETTRONICI



0405/S/EL pag. 605

MISCELATORE CON ATTIVATORE INFRAROSSO  
LAVABO  
BASIN MIXER WITH INFRARED ACTIVATOR

## 0405/N

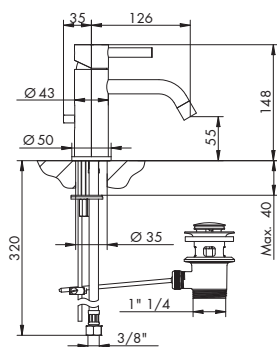

## MISCELATORE LAVABO MONOFORO

- > cartuccia tradizionale
- > interasse bocca 126
- > flessibili di alimentazione
- > con scarico



## CROMATO

01-0405/N

## ALTRE FINITURE

XX-0405/N

€ x M\*

## 0405/N/S

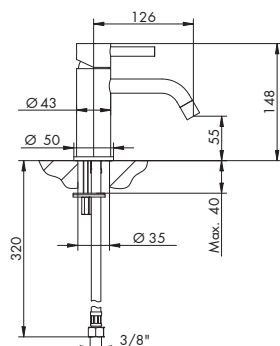

## MISCELATORE LAVABO MONOFORO

- > cartuccia tradizionale
- > interasse bocca 126
- > flessibili di alimentazione
- > senza scarico



## CROMATO

01-0405/N/S

## ALTRE FINITURE

XX-0405/N/S

€ x M\*

## 0405/NP

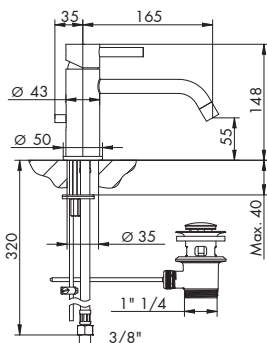
MISCELATORE LAVABO MONOFORO BOCCA  
PROLUNGATA

- > cartuccia tradizionale
- > interasse bocca 165
- > flessibili di alimentazione
- > con scarico



## CROMATO

01-0405/NP

## ALTRE FINITURE

XX-0405/NP

€ x M\*

## 0405/NP/S

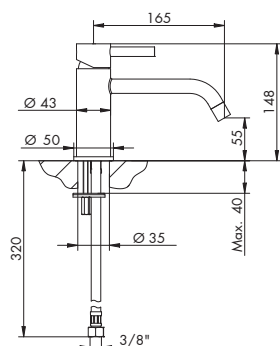
MISCELATORE LAVABO MONOFORO BOCCA  
PROLUNGATA

- > cartuccia tradizionale
- > interasse bocca 165
- > flessibili di alimentazione
- > senza scarico



## CROMATO

01-0405/NP/S

## ALTRE FINITURE

XX-0405/NP/S

€ x M\*

## 0405/NPA

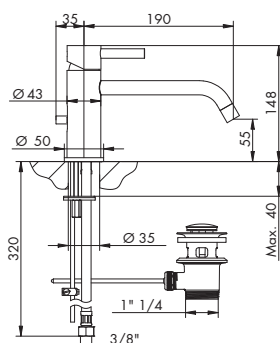
MISCELATORE LAVABO MONOFORO BOCCA  
EXTRAPROLUNGATA

- > cartuccia tradizionale
- > interasse bocca 190
- > flessibili di alimentazione
- > con scarico



## CROMATO

01-0405/NPA

## ALTRE FINITURE

XX-0405/NPA

€ x M\*

## 0405/NPA/S

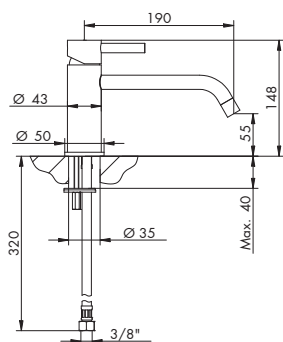
MISCELATORE LAVABO MONOFORO BOCCA  
EXTRAPROLUNGATA

- > cartuccia tradizionale
- > interasse bocca 190
- > flessibili di alimentazione
- > senza scarico



CROMATO  
01-0405/NPA/S

ALTRE FINITURE  
XX-0405/NPA/S

x M\*

## 044026 | 044027 | 044028



## PROLUNGHE MISCELATORE LAVABO

- > diametro Ø 43 mm
- > altezza 50 mm, 100 mm, 150 mm

CROMATO			ALTRE FINITURE		
01-044026	50 mm	€	XX-044026	50 mm	€
01-044027	100 mm	€	XX-044027	100 mm	€
01-044028	150 mm	€	XX-044028	150 mm	€

ALTRE FINITURE			ALTRE FINITURE		
XX-044026	50 mm	€	XX-044026	50 mm	€
XX-044027	100 mm	€	XX-044027	100 mm	€
XX-044028	150 mm	€	XX-044028	150 mm	€

x M\*

x M\*

x M\*

## 0405/4/A

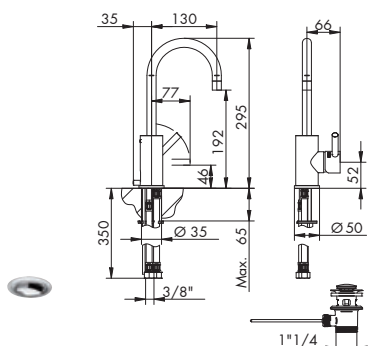

## MISCELATORE LAVABO MONOFORO BOCCA GIREVOLE

- > cartuccia tradizionale
- > interasse bocca 135
- > bocca girevole 360°
- > flessibili di alimentazione
- > con scarico



CROMATO  
01-0405/4/A

ALTRE FINITURE  
XX-0405/4/A

x M\*

## 0405/4/B

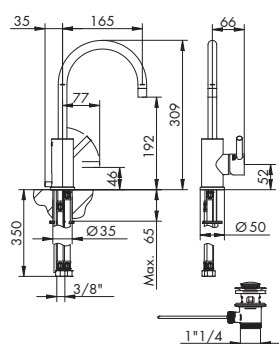
MISCELATORE LAVABO MONOFORO BOCCA  
GIREVOLE PROLUNGATA

- > cartuccia tradizionale
- > interasse bocca 165
- > bocca girevole 360°
- > flessibili di alimentazione
- > con scarico



CROMATO  
01-0405/4/B

ALTRE FINITURE  
XX-0405/4/B

x M\*

## 0405/4/C

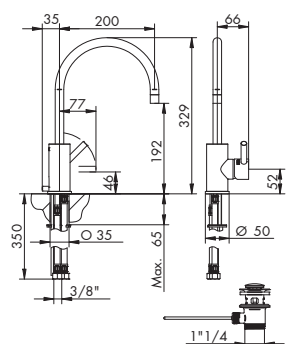
MISCELATORE LAVABO MONOFORO BOCCA  
GIREVOLE EXTRAPROLUNGATA

- > cartuccia tradizionale
- > interasse bocca 200
- > bocca girevole 360°
- > flessibili di alimentazione
- > con scarico



CROMATO  
01-0405/4/C

ALTRE FINITURE  
XX-0405/4/C

x M\*

## ACCESSORI

SCARICO C/TAPPO  
A PRESSIONE

## RICAMBI IMMEDIATI



CARTUCCIA

AERATORE  
TONDO

XX = CODICE FINITURA RICHIESTA: per identificare codice corretto vedi pag. 464  
M\* = MOLTIPLICATORE: per calcolare il prezzo delle altre finiture vedi tabella pag. 464

## 0405/4/A/J

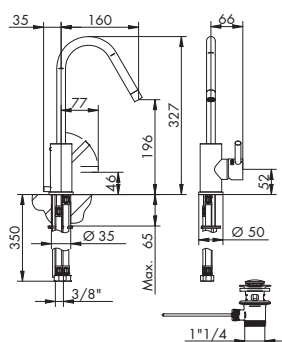

## MISCELATORE LAVABO MONOFORO BOCCA GIREVOLE JUST

- > cartuccia tradizionale
- > interasse bocca 160
- > bocca girevole 360°
- > flessibili di alimentazione
- > con scarico



CROMATO  
01-0405/4/A/J

ALTRE FINITURE  
XX-0405/4/A/J

x M\*

## 044029 | 044030 | 044031



## PROLUNGHE MISCELATORE LAVABO

- > diametro Ø 44,5 mm
- > altezza 50 mm, 100 mm, 150 mm

CROMATO		€
01-044029	50 mm	€
01-044030	100 mm	€
01-044031	150 mm	€

ALTRE FINITURE		€	
XX-044029	50 mm	€	x M*
XX-044030	100 mm	€	x M*
XX-044031	150 mm	€	x M*

## 0405/3/A/E + 104033

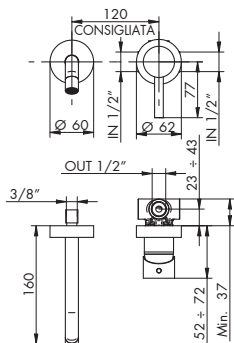

## MISCELATORE LAVABO DA PARETE

- > cartuccia tradizionale
- > interasse bocca 160
- > ingressi da 1/2"
- > senza scarico
- > rosoni separati



PARTI ESTERNE - CROMATO		€
01-0405/3/A/E		€
PARTE INCASSO		
01-104033	info pag. 32	€
PREZZO TOTALE		
		€

PARTI ESTERNE - ALTRE FINITURE		€
XX-0405/3/A/E		€

## 0405/3/B/E + 104033

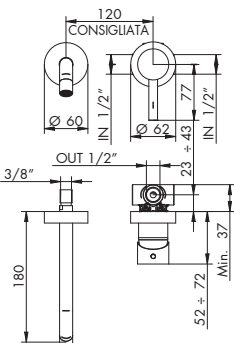

## MISCELATORE LAVABO DA PARETE BOCCA PROLUNGATA

- > cartuccia tradizionale
- > interasse bocca 180
- > ingressi da 1/2"
- > senza scarico
- > rosoni separati



PARTI ESTERNE - CROMATO		€
01-0405/3/B/E		€
PARTE INCASSO		
01-104033	info pag. 32	€
PREZZO TOTALE		
		€

PARTI ESTERNE - ALTRE FINITURE		€
XX-0405/3/B/E		€

## 0405/3/C/E + 104033

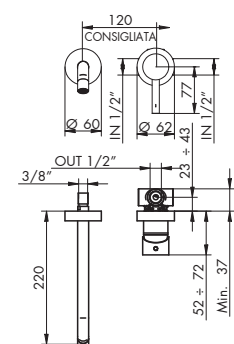

## MISCELATORE LAVABO DA PARETE BOCCA EXTRAPROLUNGATA

- > cartuccia tradizionale
- > interasse bocca 220
- > ingressi da 1/2"
- > senza scarico
- > rosoni separati



PARTI ESTERNE - CROMATO		€
01-0405/3/C/E		€
PARTE INCASSO		
01-104033	info pag. 32	€
PREZZO TOTALE		
		€

PARTI ESTERNE - ALTRE FINITURE		€
XX-0405/3/C/E		€

## 0405/3/AV/E + 104033

NEW

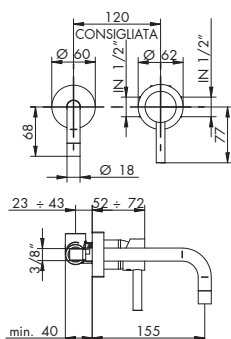

## MISCELATORE LAVABO DA PARETE BOCCA 90°

- > cartuccia tradizionale
- > interasse bocca 155
- > erogazione verticale
- > ingressi da 1/2"
- > senza scarico
- > rosoni separati

	0136 - 0136/1 p. 717
	025002 p. 149
	014073 p. 140

## PARTI ESTERNE - CROMATO

01-0405/3/AV/E €

## PARTI ESTERNE - ALTRE FINITURE

XX-0405/3/AV/E €

## PARTE INCASSO

01-104033 info pag. 32 €

PREZZO TOTALE €

## 0405/3/BV/E + 104033

NEW

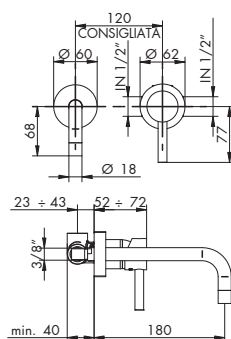

## MISCELATORE LAVABO DA PARETE BOCCA 90°

## PROLUNGATA

- > cartuccia tradizionale
- > interasse bocca 180
- > erogazione verticale
- > ingressi da 1/2"
- > senza scarico
- > rosoni separati

	0136 - 0136/1 p. 717
	025002 p. 149
	014073 p. 140

## PARTI ESTERNE - CROMATO

01-0405/3/BV/E €

## PARTI ESTERNE - ALTRE FINITURE

XX-0405/3/BV/E €

## PARTE INCASSO

01-104033 info pag. 32 €

PREZZO TOTALE €

## 0405/3/CV/E + 104033

NEW

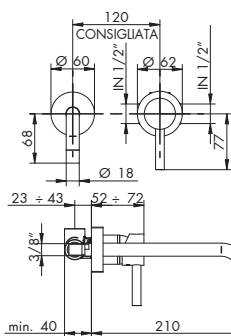

## MISCELATORE LAVABO DA PARETE BOCCA 90°

## EXTRAPROLUNGATA

- > cartuccia tradizionale
- > interasse bocca 210
- > erogazione verticale
- > ingressi da 1/2"
- > senza scarico
- > rosoni separati

	0136 - 0136/1 p. 717
	025002 p. 149
	014073 p. 140

## PARTI ESTERNE - CROMATO

01-0405/3/CV/E €

## PARTI ESTERNE - ALTRE FINITURE

XX-0405/3/CV/E €

## PARTE INCASSO

01-104033 info pag. 32 €

PREZZO TOTALE €

## 0405/3/1/E + 894001

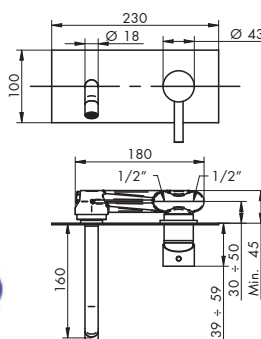

## MISCELATORE LAVABO DA PARETE SU PIASTRA

- > cartuccia tradizionale
- > interasse bocca 160
- > ingressi da 1/2"
- > senza scarico
- > piastra unica

	0136 - 0136/1 p. 717
	025002 p. 149
	014073 p. 140

## PARTI ESTERNE - CROMATO

01-0405/3/1/E €

## PARTI ESTERNE - ALTRE FINITURE

XX-0405/3/1/E €

## PARTE INCASSO

01-894001 info pag. 34 €

PREZZO TOTALE €

## 0405/3/2/E + 894001

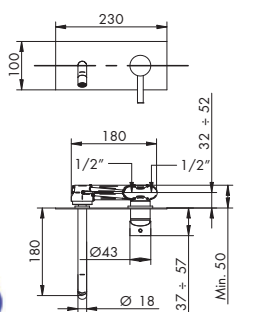

## MISCELATORE LAVABO DA PARETE BOCCA

## PROLUNGATA SU PIASTRA

- > cartuccia tradizionale
- > interasse bocca 180
- > ingressi da 1/2"
- > senza scarico
- > piastra unica

	0136 - 0136/1 p. 717
	025002 p. 149
	014073 p. 140

## PARTI ESTERNE - CROMATO

01-0405/3/2/E €

## PARTI ESTERNE - ALTRE FINITURE

XX-0405/3/2/E €

## PARTE INCASSO

01-894001 info pag. 34 €

PREZZO TOTALE €

## ACCESSORI

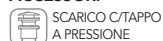
SCARICO C/TAPPO  
A PRESSIONE

## RICAMBI IMMEDIATI



CARTUCCIA

AERATORE  
TONDO

XX = CODICE FINITURA RICHIESTA: per identificare codice corretto vedi pag. 464  
M\* = MOLTIPLICATORE: per calcolare il prezzo delle altre finiture vedi tabella pag. 464

## 0405/3/3/E + 894001

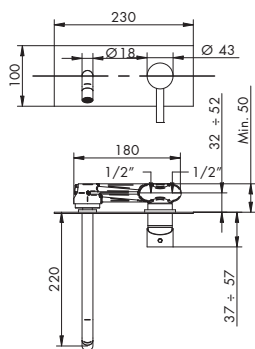
MISCELATORE LAVABO DA PARETE BOCCA  
EXTRAPROLUNGATA SU PIASTRA

- > cartuccia tradizionale
- > interasse bocca 220
- > ingressi da 1/2"
- > senza scarico
- > piastra unica



## PARTI ESTERNE - CROMATO

01-0405/3/3/E €

## PARTI ESTERNE - ALTRE FINITURE

XX-0405/3/3/E €

## PARTE INCASSO

01-894001 info pag. 34 €

PREZZO TOTALE €

## 0405/3/1V/E + 894001

NEW

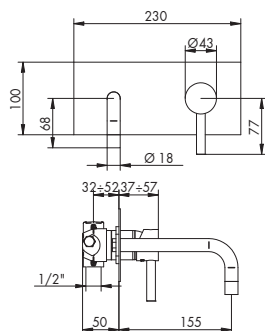
MISCELATORE LAVABO DA PARETE BOCCA 90°  
SU PIASTRA

- > cartuccia tradizionale
- > interasse bocca 155
- > erogazione verticale
- > ingressi da 1/2"
- > senza scarico
- > piastra unica



## PARTI ESTERNE - CROMATO

01-0405/3/1V/E €

## PARTI ESTERNE - ALTRE FINITURE

XX-0405/3/1V/E €

## PARTE INCASSO

01-894001 info pag. 34 €

PREZZO TOTALE €

## 0405/3/2V/E + 894001

NEW

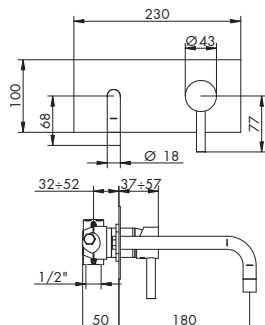
MISCELATORE LAVABO DA PARETE BOCCA 90°  
PROLUNGATA SU PIASTRA

- > cartuccia tradizionale
- > interasse bocca 180
- > erogazione verticale
- > ingressi da 1/2"
- > senza scarico
- > piastra unica



## PARTI ESTERNE - CROMATO

01-0405/3/2V/E €

## PARTI ESTERNE - ALTRE FINITURE

XX-0405/3/2V/E €

## PARTE INCASSO

01-894001 info pag. 34 €

PREZZO TOTALE €

## 0405/3/3V/E + 894001

NEW

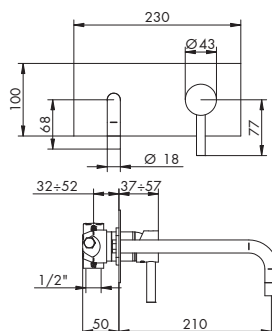
MISCELATORE LAVABO DA PARETE BOCCA 90°  
EXTRA PROLUNGATA SU PIASTRA

- > cartuccia tradizionale
- > interasse bocca 210
- > erogazione verticale
- > ingressi da 1/2"
- > senza scarico
- > piastra unica



## PARTI ESTERNE - CROMATO

01-0405/3/3V/E €

## PARTI ESTERNE - ALTRE FINITURE

XX-0405/3/3V/E €

## PARTE INCASSO

01-894001 info pag. 34 €

PREZZO TOTALE €

## 0405/PT/E + 734012

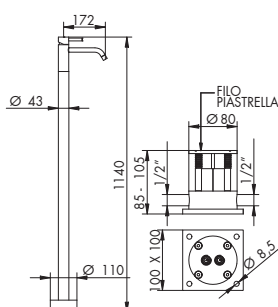
MISCELATORE LAVABO C/ATTACCHI A  
PAVIMENTO

- > cartuccia tradizionale
- > interasse bocca 172
- > parte incasso attacchi da 1/2"
- > senza scarico



## PARTI ESTERNE - CROMATO

01-0405/PT/E €

## PARTI ESTERNE - ALTRE FINITURE

XX-0405/PT/E €1.080,00 x M\*

## PARTE INCASSO

01-734012 info pag. 34 €

PREZZO TOTALE €

## 0405/PAT/E + 734012

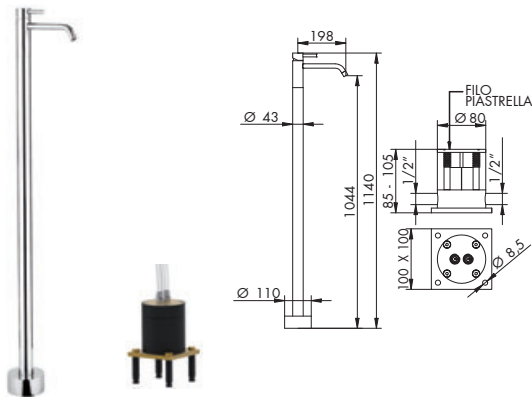

## MISCELATORE LAVABO C/ATTACCHI A PAVIMENTO

- > cartuccia tradizionale
- > interasse bocca 198
- > parte incasso attacchi da 1/2"
- > senza scarico



## PARTI ESTERNE - CROMATO

01-0405/PAT/E €

## PARTI ESTERNE - ALTRE FINITURE

XX-0405/PAT/E €

## PARTE INCASSO

01-734012 info pag. 34 €

PREZZO TOTALE €

## 0410/BT/E + 734012

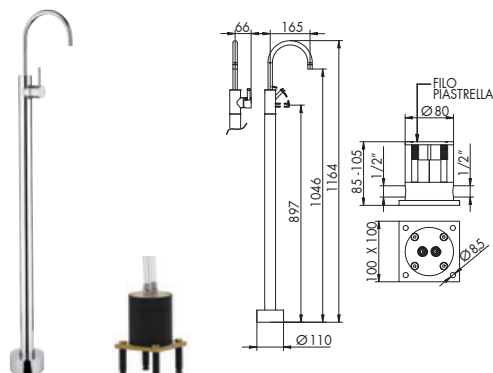

## MISCELATORE LAVABO C/ATTACCHI A PAVIMENTO BOCCA GIREVOLE

- > cartuccia tradizionale
- > interasse bocca 165
- > bocca girevole 360°
- > parte incasso attacchi da 1/2"
- > senza scarico



## PARTI ESTERNE - CROMATO

01-0410/BT/E €

## PARTI ESTERNE - ALTRE FINITURE

XX-0410/BT/E €

## PARTE INCASSO

01-734012 info pag. 34 €

PREZZO TOTALE €

## 0410/CT/E + 734012

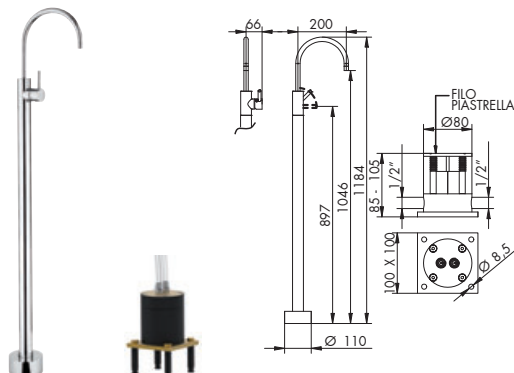

## MISCELATORE LAVABO C/ATTACCHI A PAVIMENTO BOCCA GIREVOLE PROLUNGATA

- > cartuccia tradizionale
- > interasse bocca 200
- > bocca girevole 360°
- > parte incasso attacchi da 1/2"
- > senza scarico



## PARTI ESTERNE - CROMATO

01-0410/CT/E €

## PARTI ESTERNE - ALTRE FINITURE

XX-0410/CT/E €

## PARTE INCASSO

01-734012 info pag. 34 €

PREZZO TOTALE €

## 0410/JT/E + 734012

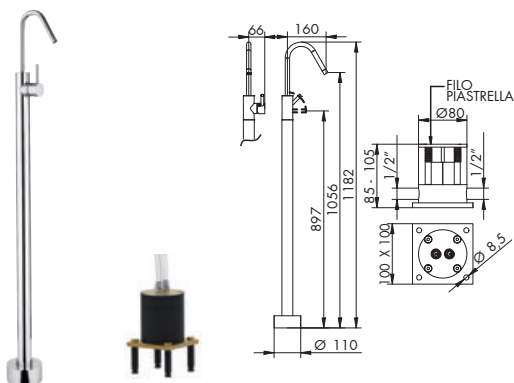

## MISCELATORE LAVABO C/ATTACCHI A PAVIMENTO BOCCA JUST GIREVOLE

- > cartuccia tradizionale
- > interasse bocca 160
- > bocca girevole Just 360°
- > parte incasso attacchi da 1/2"
- > senza scarico



## PARTI ESTERNE - CROMATO

01-0410/JT/E €

## PARTI ESTERNE - ALTRE FINITURE

XX-0410/JT/E €

## PARTE INCASSO

01-734012 info pag. 34 €

PREZZO TOTALE €

## 0405/R/A

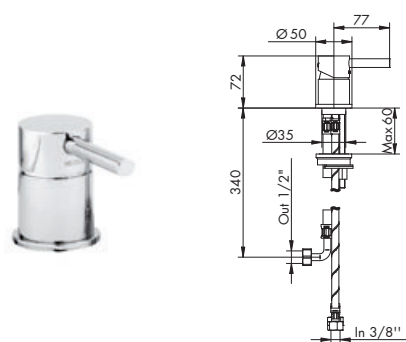

## MISCELATORE REMOTO

- > cartuccia tradizionale
- > flessibili di alimentazione
- > senza scarico

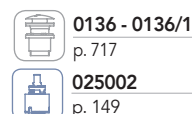

## CROMATO

01-0405/R/A

## ALTRE FINITURE

XX-0405/R/A x M\*

## ACCESSORI

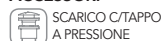

## RICAMBI IMMEDIATI



XX = CODICE FINITURA RICHIESTA: per identificare codice corretto vedi pag. 464  
 M\* = MOLTIPLICATORE: per calcolare il prezzo delle altre finiture vedi tabella pag. 464



## 0405/R/B/E + 104033

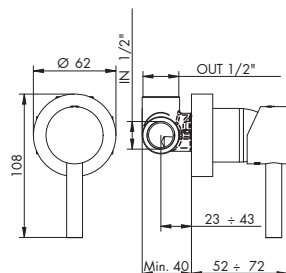

## MISCELATORE INCASSO REMOTO

- > cartuccia tradizionale
- > ingressi da 1/2"
- > uscita superiore
- > rosone tondo
- > senza scarico

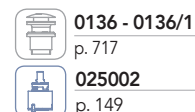
0136 - 0136/1  
p. 717025002  
p. 149

## PARTI ESTERNE - CROMATO

01-0405/R/B/E €

## PARTI ESTERNE - ALTRE FINITURE

XX-0405/R/B/E €

## PARTE INCASSO

01-104033 info pag. 32 €

PREZZO TOTALE €

## 0405/R/BQ/E + 104033

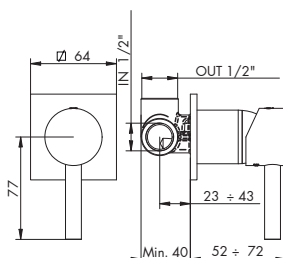

## MISCELATORE INCASSO REMOTO

- > cartuccia tradizionale
- > ingressi da 1/2"
- > uscita superiore
- > rosone quadro
- > senza scarico

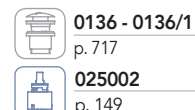
0136 - 0136/1  
p. 717025002  
p. 149

## PARTI ESTERNE - CROMATO

01-0405/R/BQ/E €

## PARTI ESTERNE - ALTRE FINITURE

XX-0405/R/BQ/E €

## PARTE INCASSO

01-104033 info pag. 32 €

PREZZO TOTALE €

## 0405/1/A

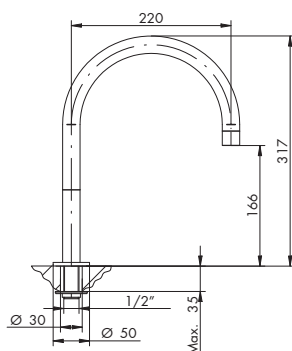

## BOCCA LAVABO

- > ingresso da 1/2"
- > interasse 220
- > altezza d'erogazione 165
- > senza scarico

0136 - 0136/1  
p. 717014074  
p. 140

## CROMATO

01-0405/1/A

## ALTRE FINITURE

XX-0405/1/A

x M\*

## 0405/1/A/J

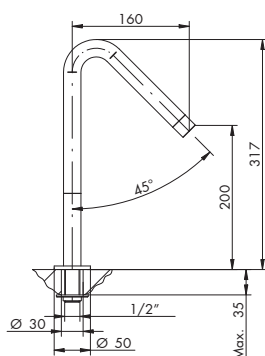

## BOCCA LAVABO JUST

- > ingresso da 1/2"
- > interasse 160
- > altezza d'erogazione 200
- > senza scarico

0136 - 0136/1  
p. 717014074  
p. 140

## CROMATO

01-0405/1/A/J

## ALTRE FINITURE

XX-0405/1/A/J

x M\*

## 0405/1/B

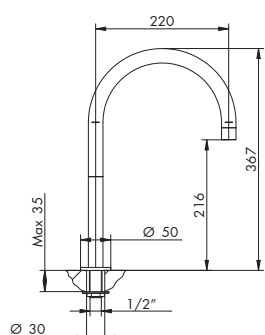

## BOCCA LAVABO MEDIUM

- > ingresso da 1/2"
- > interasse 220
- > altezza d'erogazione 216
- > senza scarico

0136 - 0136/1  
p. 717014074  
p. 140

## CROMATO

01-0405/1/B

## ALTRE FINITURE

XX-0405/1/B

x M\*

## 0405/1/B/J

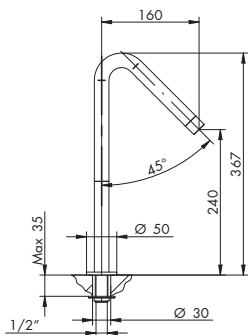

## BOCCA LAVABO JUST MEDIUM

- > ingresso da 1/2"
- > interasse 160
- > altezza d'erogazione 240
- > senza scarico



## CROMATO

01-0405/1/B/J

## ALTRE FINITURE

XX-0405/1/B/J

x M\*

## 0405/1/C

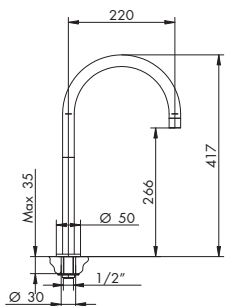

## BOCCA LAVABO ALTA

- > ingresso da 1/2"
- > interasse 220
- > altezza d'erogazione 266
- > senza scarico



## CROMATO

01-0405/1/C

## ALTRE FINITURE

XX-0405/1/C

x M\*

## 0405/1/C/J

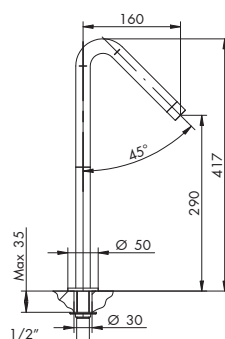

## BOCCA LAVABO JUST ALTA

- > ingresso da 1/2"
- > interasse 160
- > altezza d'erogazione 290
- > senza scarico

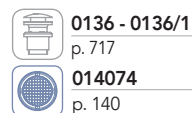

## CROMATO

01-0405/1/C/J

## ALTRE FINITURE

XX-0405/1/C/J

x M\*

## 0405/26

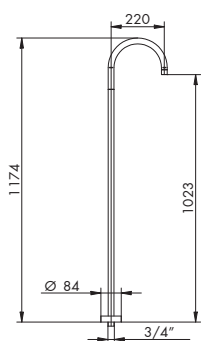

## BOCCA LAVABO CON ATTACCO A PAVIMENTO

- > ingresso da 3/4"
- > interasse bocca 220
- > altezza d'erogazione 1023
- > senza scarico



## CROMATO

01-0405/26

## ALTRE FINITURE

XX-0405/26

x M\*

## 0407/N

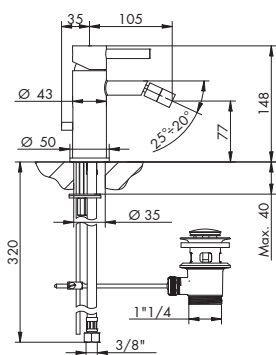

## MISCELATORE BIDET MONOFORO

- > cartuccia tradizionale
- > interasse bocca 105
- > aeratore snodato
- > flessibili di alimentazione
- > con scarico



## CROMATO

01-0407/N

## ALTRE FINITURE

XX-0407/N

x M\*

## ACCESSORI

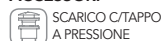
SCARICO C/TAPPO  
A PRESSIONE

## RICAMBI IMMEDIATI



CARTUCCIA

AERATORE  
TONDO

XX = CODICE FINITURA RICHIESTA: per identificare codice corretto vedi pag. 464  
M\* = MOLTIPLICATORE: per calcolare il prezzo delle altre finiture vedi tabella pag. 464

0407/2

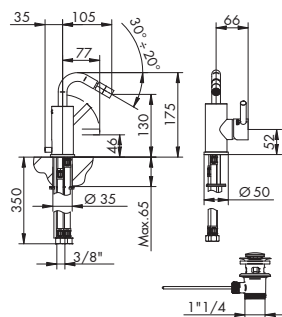

MISCELATORE BIDET MONOFORO LEVA LATERALE

BOCCA GIREVOLE

- > cartuccia tradizionale
- > interasse bocca 105
- > aeratore snodato
- > flessibili di alimentazione
- > con scarico



025002 p. 149  
054031 p. 140

CROMATO  
01-0407/2

ALTRE FINITURE  
XX-0407/2

x M\*

0421/N/E + 104018

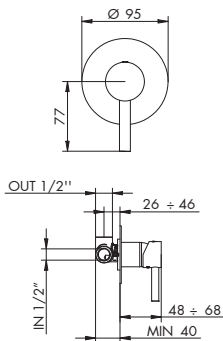

MISCELATORE INCASSO

- > cartuccia tradizionale
- > attacchi da 1/2"
- > uscita superiore
- > incasso con B-Box



025002 p. 149

PARTI ESTERNE - CROMATO  
01-0421/N/E €

PARTI ESTERNE - ALTRE FINITURE  
XX-0421/N/E €

PARTE INCASSO  
01-104018 info pag. 36 €

PREZZO TOTALE €

0421/Q/E + 104018

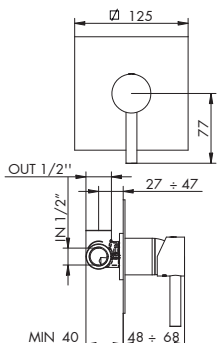

MISCELATORE INCASSO

- > cartuccia tradizionale
- > ingressi da 1/2"
- > uscita superiore
- > incasso con B-Box
- > piastra quadra



025002 p. 149

PARTI ESTERNE - CROMATO  
01-0421/Q/E €

PARTI ESTERNE - ALTRE FINITURE  
XX-0421/Q/E €

PARTE INCASSO  
01-104018 info pag. 36 €

PREZZO TOTALE €

0400/E + 104002

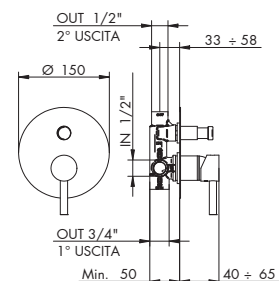

MISCELATORE INCASSO C/DEVIATORE 2 USCITE

- > cartuccia tradizionale
- > deviatore a pressione 2 uscite c/ritorno automatico e blocco meccanico basse pressioni
- > attacchi da 1/2"
- > uscita principale inferiore da 3/4"
- > incasso con B-Box

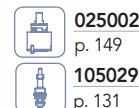

025002 p. 149  
105029 p. 131

PARTI ESTERNE - CROMATO  
01-0400/E €

PARTI ESTERNE - ALTRE FINITURE  
XX-0400/E €

PARTE INCASSO  
01-104002 info pag. 37 €

PREZZO TOTALE €

0400/Q/E + 104002

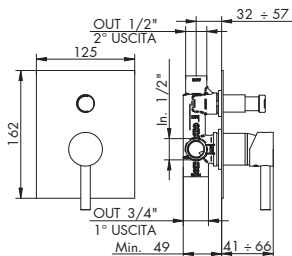

MISCELATORE INCASSO C/DEVIATORE 2 USCITE

- > cartuccia tradizionale
- > deviatore a pressione 2 uscite c/ritorno automatico e blocco meccanico basse pressioni
- > piastra rettangolare
- > attacchi da 1/2"
- > uscita principale inferiore da 3/4"
- > Incasso con B-Box

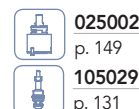

025002 p. 149  
105029 p. 131

PARTI ESTERNE - CROMATO  
01-0400/Q/E €

PARTI ESTERNE - ALTRE FINITURE  
XX-0400/Q/E €

PARTE INCASSO  
01-104002 info pag. 37 €

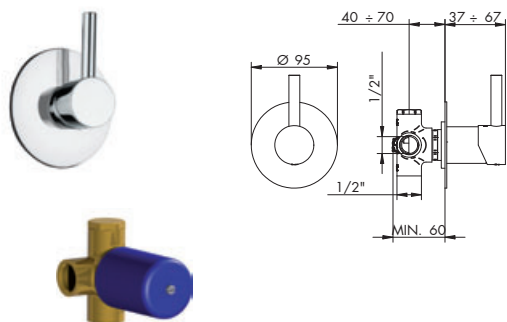

PREZZO TOTALE €

0403/2/1N/E + 914016



DEVIATORE INCASSO 2 USCITE

> deviatore a dischi ceramici 2 uscite senza chiusura  
> attacchi da 1/2"

 **635010**  
p. 131  
 **035346** fino 9.2017  
p. 131

PARTI ESTERNE - CROMATO	
01-0403/2/1N/E	€
PARTE INCASSO	
914016	info pag. 38 €
<b>PREZZO TOTALE</b>	<b>€</b>

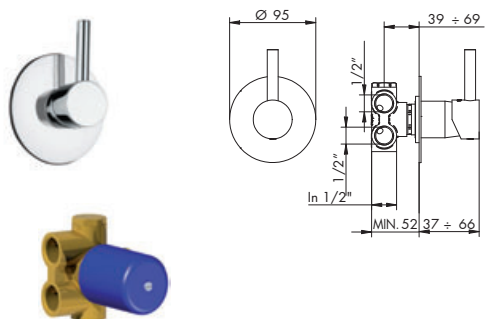

PARTI ESTERNE - ALTRE FINITURE	
<b>XX-0403/2/1N/E</b>	€

0403/3/1N/E + 034127



DEVIATORE INCASSO 3 USCITE

> deviatore a dischi ceramici 3 uscite senza chiusura  
> attacchi da 1/2"

 **635011**  
p. 131  
 **035345** fino 9.2017  
p. 131

PARTI ESTERNE - CROMATO	
01-0403/3/1N/E	€
PARTE INCASSO	
034127	info pag. 38 €
<b>PREZZO TOTALE</b>	<b>€ 236,00</b>

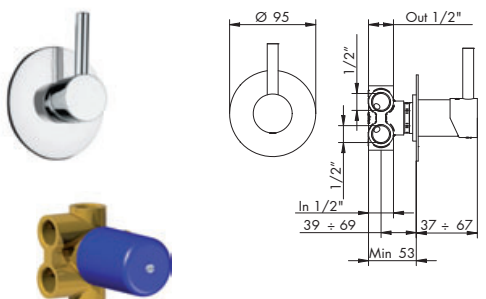

PARTI ESTERNE - ALTRE FINITURE	
<b>XX-0403/3/1N/E</b>	€

0403/4/1N/E + 034128



DEVIATORE INCASSO 4 USCITE

> deviatore a dischi ceramici 4 uscite senza chiusura  
> attacchi da 1/2"

 **635012**  
p. 131  
 **035344** fino 9.2017  
p. 131

PARTI ESTERNE - CROMATO	
01-0403/4/1N/E	€
PARTE INCASSO	
034128	info pag. 38 €
<b>PREZZO TOTALE</b>	<b>€ 260,00</b>

PARTI ESTERNE - ALTRE FINITURE	
<b>XX-0403/4/1N/E</b>	€

I DOCCIA INCASSO TERMOSTATICO CONSIGLIATI SONO PRESENTI SU LISTINO REVIVRE

- 8812/H/P/E + 484020
- 8812/2/P/E + 484021
- 8812/3/P/E + 484022
- 8812/4/P/E + 484023

I DOCCIA COMPLEMENTI CONSIGLIATI SONO PRESENTI SU LISTINO REVIVRE

- |          |             |      |
|----------|-------------|------|
| 4403/1/A | 0530        | 0514 |
| 4403/1   | 0530/1      |      |
| 0403/1/B | 0413/4/SP   |      |
| 0403/1/C | 0413/5/1/SP |      |

0409/1

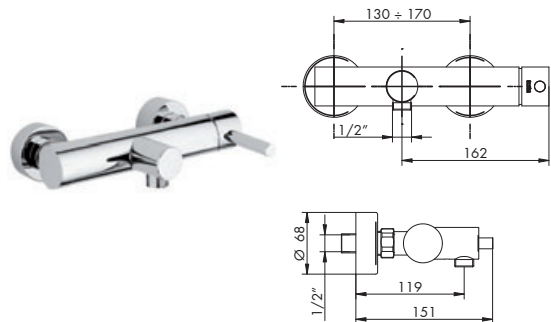

MISCELATORE DOCCIA ESTERNO

> cartuccia tradizionale  
> senza set doccia  
> attacchi da 1/2"

 **025002**  
p. 149

CROMATO	
01-0409/1	€

ALTRE FINITURE	
<b>XX-0409/1</b>	€ x M*

RICAMBI IMMEDIATI



**XX = CODICE FINITURA RICHIESTA:** per identificare codice corretto vedi pag. 464  
**M\* = MOLTIPLICATORE:** per calcolare il prezzo delle altre finiture vedi tabella pag. 464

## 0409/4/SP

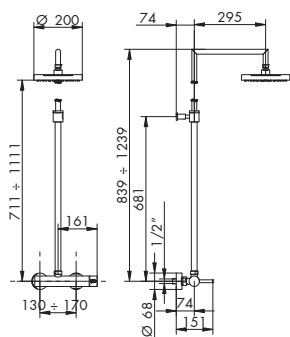

## MISCELATORE DOCCIA ESTERNO C/STELO

- > cartuccia tradizionale
- > stelo regolabile
- > soffione orientabile Ø200 in ABS con anticalcare
- > attacchi da 1/2"
- > per finiture diverse da cromo soffione in metallo

025002  
p. 149

## CROMATO

01-0409/4/SP

## ALTRE FINITURE

XX-0409/4/SP

x M\*

## 0409/5/1/SP

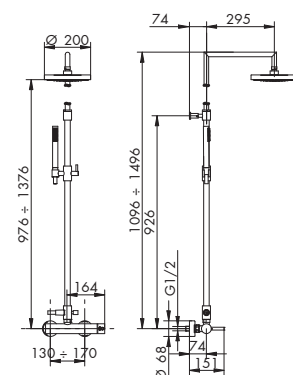

## MISCELATORE DOCCIA ESTERNO C/STELO COMPLETO

- > cartuccia tradizionale
- > stelo regolabile
- > deviatore a trazione c/ritorno automatico e blocco meccanico bassa pressione
- > soffione orientabile Ø200 in ABS c/anticalcare
- > flessibile in PVC 150 cm
- > Supporto doccetta scorrevole > attacchi da 1/2"
- > doccetta monogetto cilindrica in ABS c/anticalcare
- > per finiture diverse da cromo doccetta e soffione in metallo

025002  
p. 149045073  
p. 131

## CROMATO

01-0409/5/1/SP

## ALTRE FINITURE

XX-0409/5/1/SP

x M\*

## 0411/1A

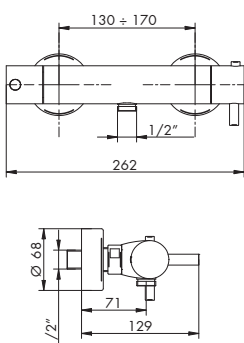

## MISCELATORE DOCCIA ESTERNO TERMOSTATICO

- > cartuccia termostatica
- > vitone ceramico 90°
- > senza set doccia
- > attacchi da 1/2"

885041  
p. 150055002  
p. 151

## CROMATO

01-0411/1A

## ALTRE FINITURE

XX-0411/1A

x M\*

## 0411/4A

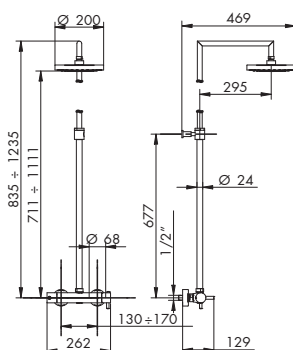

## MISCELATORE DOCCIA ESTERNO TERMOSTATICO C/STELO

- > cartuccia termostatica
- > stelo regolabile
- > soffione orientabile Ø200 in ABS con anticalcare
- > attacchi da 1/2"
- > per finiture diverse da cromo soffione in metallo

885041  
p. 150055002  
p. 151

## CROMATO

01-0411/4A

## ALTRE FINITURE

XX-0411/4A

x M\*

## 0411/5A

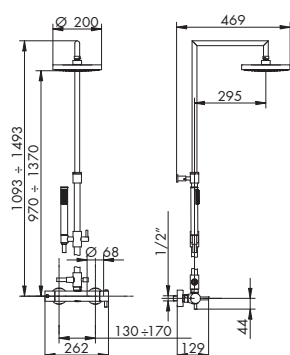

## MISCELATORE DOCCIA ESTERNO TERMOSTATICO C/STELO COMPLETO

- > cartuccia termostatica
- > stelo regolabile
- > deviatore a trazione c/ritorno automatico e blocco meccanico bassa pressione
- > soffione orientabile Ø200 c/anticalcare
- > flessibile in PVC 150 cm
- > supporto doccetta scorrevole > attacchi da 1/2"
- > doccetta monogetto cilindrica in ABS c/anticalcare
- > per finiture diverse da cromo doccetta e soffione in metallo

755053  
p. 150055002  
p. 151045073  
p. 131

## CROMATO

01-0411/5A

## ALTRE FINITURE

XX-0411/5A

x M\*



0401/A

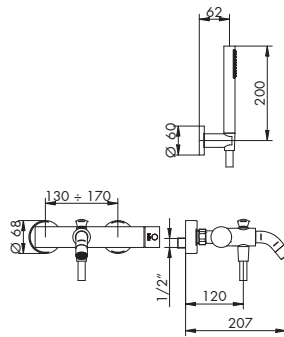

MISCELATORE VASCA ESTERNO

- > cartuccia tradizionale
- > Interasse bocca 207
- > deviatore a trazione c/ritorno automatico e blocco meccanico per basse pressioni
- > flessibile in PVC 150 cm
- > supporto a parete fisso > attacchi da 1/2"
- > doccetta monogetto cilindrica in ABS c/anticalcare, per finiture diverse da cromo doccetta in metallo

- 025002**  
p. 149
- 014072**  
p. 130
- 014074**  
p. 140

CROMATO	ALTRE FINITURE
01-0401/A	XX-0401/A x M*

0401/2/A

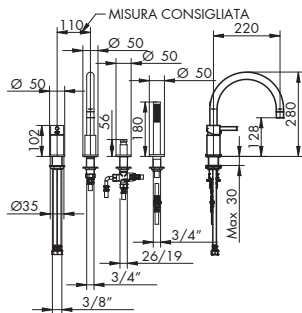

MISCELATORE PER BORDO VASCA

- > cartuccia tradizionale
- > interasse bocca 220 > bocca girevole 360°
- > deviatore a pressione c/ritorno automatico e blocco meccanico per basse pressioni
- > flessibile in PVC 150 cm
- > flessibili di alimentazione > senza scarico
- > doccetta monogetto cilindrica in ABS c/anticalcare, per finiture diverse da cromo doccetta in metallo
- > PREDISPOSIZIONI per bordo vasca, art. 012/4, 012/6 e 012/7, vedi pag. 615

- 025002**  
p. 149
- 724030**  
p. 132
- 014074**  
p. 140

CROMATO	ALTRE FINITURE
01-0401/2/A	XX-0401/2/A x M*

0401/2/J/A

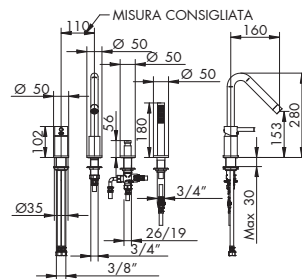

MISCELATORE PER BORDO VASCA JUST

- > cartuccia tradizionale
- > interasse bocca 160 > bocca girevole 360°
- > deviatore a pressione c/ritorno automatico e blocco meccanico per basse pressioni
- > flessibile in PVC 150 cm > flessibili di alimentazione
- > senza scarico > bocca tipo Just
- > doccetta monogetto cilindrica in ABS c/anticalcare, per finiture diverse da cromo doccetta in metallo
- > PREDISPOSIZIONI per bordo vasca, art. 012/4, 012/6 e 012/7, vedi pag. 615

- 025002**  
p. 149
- 724030**  
p. 132
- 014074**  
p. 140

CROMATO	ALTRE FINITURE
01-0401/2/J/A	XX-0401/2/J/A x M*

0401/2/P/A

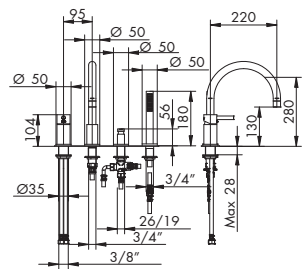

MISCELATORE PER BORDO VASCA C/PIASTRA

- > cartuccia tradizionale
- > interasse bocca 220
- > bocca girevole 360°
- > deviatore a pressione c/ritorno automatico e blocco meccanico per basse pressioni
- > flessibile in PVC 150Cm > flessibili di alimentazione
- > senza scarico > piastra estetica interasse fori 95mm
- > doccetta monogetto cilindrica in ABS c/anticalcare, per finiture diverse da cromo doccetta in metallo

- 025002**  
p. 149
- 724030**  
p. 132
- 014074**  
p. 140

CROMATO	ALTRE FINITURE
01-0401/2/P/A	XX-0401/2/P/A x M*

0401/2/J/P/A

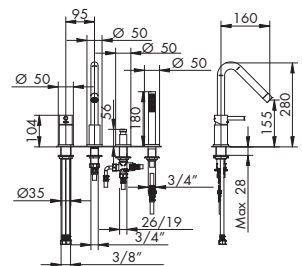

MISCELATORE PER BORDO VASCA C/PIASTRA JUST

- > cartuccia tradizionale
- > interasse bocca 160 > bocca girevole 360°
- > deviatore a pressione c/ritorno automatico e blocco meccanico per basse pressioni
- > flessibile in PVC 150 cm > flessibili di alimentazione
- > senza scarico > bocca tipo Just
- > piastra estetica interasse fori 95 mm
- > doccetta monogetto cilindrica in ABS c/anticalcare, per finiture diverse da cromo doccetta in metallo

- 025002**  
p. 149
- 724030**  
p. 132
- 014074**  
p. 140

CROMATO	ALTRE FINITURE
01-0401/2/J/P/A	XX-0401/2/J/P/A x M*

0401/20/A

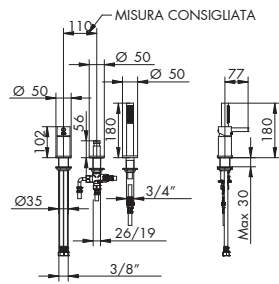

MISCELATORE PER BORDO VASCA S/BOCCA

- > cartuccia tradizionale
- > senza bocca
- > deviatore a pressione c/ritorno automatico e blocco meccanico per basse pressioni
- > flessibile in PVC 150 cm > flessibili di alimentazione
- > senza scarico
- > doccetta monogetto cilindrica in ABS c/anticalcare, per finiture diverse da cromo doccetta in metallo
- > PREDISPOSIZIONI per bordo vasca, art. 012/3, 012/6 e 012/7, vedi pag. 615

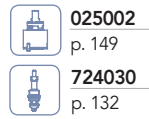

025002 p. 149  
724030 p. 132

CROMATO  
01-0401/20/A

ALTRE FINITURE  
XX-0401/20/A

x M\*

0401/20/P/A

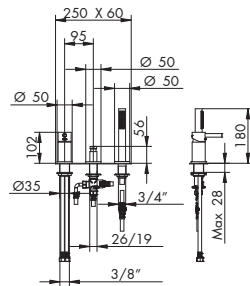

MISCELATORE PER BORDO VASCA

- > cartuccia tradizionale
- > senza bocca
- > deviatore a pressione c/ritorno automatico e blocco meccanico per basse pressioni
- > flessibile in PVC 150 cm > flessibili di alimentazione
- > senza scarico
- > piastra estetica interasse fori 95 mm
- > doccetta monogetto cilindrica in ABS c/anticalcare, per finiture diverse da cromo doccetta in metallo

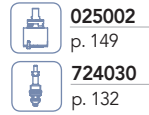

025002 p. 149  
724030 p. 132

CROMATO  
01-0401/20/P/A

ALTRE FINITURE  
XX-0401/20/P/A

x M\*

0401/4/AE + 734012

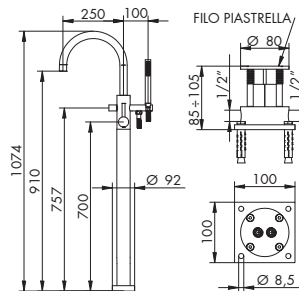

MISCELATORE VASCA C/ATTACCO A PAVIMENTO

- > cartuccia tradizionale
- > interasse bocca 250 > bocca girevole 360°
- > deviatore a trazione con ritorno automatico e blocco meccanico per basse pressioni
- > flessibile in PVC 150 cm > supporto doccia incorporato
- > incasso a pavimento con attacchi da 1/2"
- > doccetta monogetto cilindrica in ABS c/anticalcare, per finiture diverse da cromo doccetta in metallo



025002 p. 149  
014075 p. 140

PARTI ESTERNE - CROMATO  
01-0401/4/AE €

PARTI ESTERNE - ALTRE FINITURE  
XX-0401/4/AE €

PARTE INCASSO  
734012 info pag. 34 €

PREZZO TOTALE €

0401/4/JAE + 734012

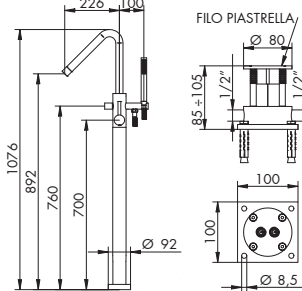

MISCELATORE VASCA C/ATTACCO A PAVIMENTO BOCCA JUST

- > cartuccia tradizionale
- > Interasse bocca 226 > bocca girevole 360° tipo Just
- > deviatore a trazione con ritorno automatico e blocco meccanico per basse pressioni
- > flessibile in PVC 150 cm > supporto doccia incorporato
- > incasso a pavimento con attacchi da 1/2"
- > doccetta monogetto cilindrica in ABS c/anticalcare, per finiture diverse da cromo doccetta in metallo



025002 p. 149  
014075 p. 140

PARTI ESTERNE - CROMATO  
01-0401/4/JAE €

PARTI ESTERNE - ALTRE FINITURE  
XX-0401/4/JAE €

PARTE INCASSO  
734012 info pag. 34 €

PREZZO TOTALE €

0103

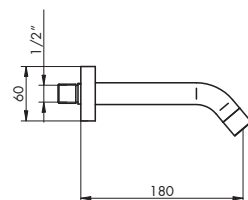

BOCCA VASCA DA PARETE

- > interasse bocca 180
- > attacco da 3/4"



014074 p. 140

CROMATO  
01-0103

ALTRE FINITURE  
XX-0103

x M\*

0401/26

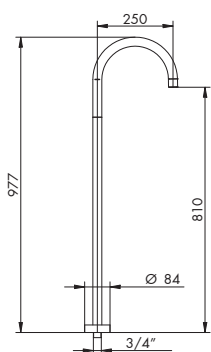

BOCCA VASCA DA PAVIMENTO

> interasse bocca 250  
> attacco da 3/4"

 014075  
p. 140

CROMATO	
01-0401/26	€

ALTRE FINITURE	
XX-0401/26	€

0401/26/J

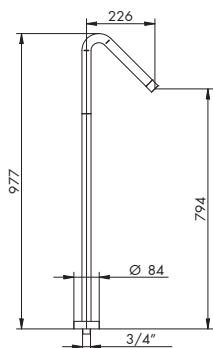

BOCCA VASCA JUST CON ATTACCO A PAVIMENTO

> Interasse bocca 226 tipo Just  
> attacco da 3/4"

 014075  
p. 140

CROMATO	
01-0401/26/J	€

ALTRE FINITURE	
XX-0401/26/J	€

0408/E+ 054025 DX o 054026 SX

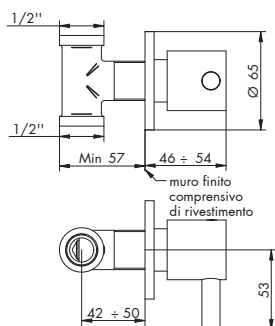

RUBINETTO D'ARRESTO 1/2"

> vitone ceramico 90°  
> ingressi da 1/2"

 055001  
p. 151

 055002  
p. 151

PARTI ESTERNE - CROMATO	
01-0408/E	€

PARTI ESTERNE - ALTRE FINITURE	
XX-0408/E	€

PARTE INCASSO	
054025 o 054026	info pag. 40 €

PREZZO TOTALE	
	€

0408/E + 054027 DX o 054028 SX

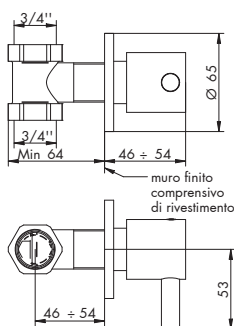

RUBINETTO D'ARRESTO 3/4"

> vitone ceramico 90°  
> ingressi da 3/4"

 055001  
p. 151

 055002  
p. 151

PARTI ESTERNE - CROMATO	
01-0408/E	€

PARTI ESTERNE - ALTRE FINITURE	
XX-0408/E	€

PARTE INCASSO	
054027 o 054028	info pag. 40 €

PREZZO TOTALE	
	€

0440/E + 884053

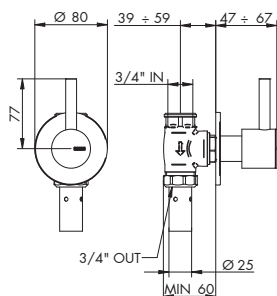

PASSO RAPIDO 3/4"

> vitone tradizionale  
> abbinare a saracinesca  
> ingressi da 3/4"

 884021  
p. 151

PARTI ESTERNE - CROMATO	
01-0440/E	€

PARTI ESTERNE - ALTRE FINITURE	
XX-0440/E	€

PARTE INCASSO	
884053	info pag. 42 €

PREZZO TOTALE	
	€

RICAMBI IMMEDIATI



XX = CODICE FINITURA RICHIESTA: per identificare codice corretto vedi pag. 464  
M\* = MOLTIPLICATORE: per calcolare il prezzo delle altre finiture vedi tabella pag. 464



## 0440/E + 884054

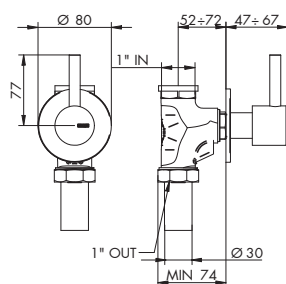

## PASSO RAPIDO 1"

- > vitone tradizionale
- > abbinare a saracinesca
- > ingressi da 1"

884021  
p. 151

## PARTI ESTERNE - CROMATO

01-0440/E €

## PARTI ESTERNE - ALTRE FINITURE

XX-0440/E €

## PARTE INCASSO

884054 info pag. 42 €

PREZZO TOTALE €

## 0432/2/E + 035212

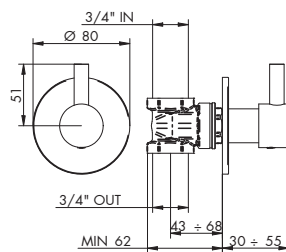

## SARACINESCA

- > attacchi da 3/4"

## PARTI ESTERNE - CROMATO

01-0432/2/E €

## PARTI ESTERNE - ALTRE FINITURE

XX-0432/2/E €

## PARTE INCASSO

035212 info pag. 42 €

PREZZO TOTALE €

