



ZEHN

EQB DESIGN



TABELLA PREZZI FINITURE	pag. 330
INFO TECNICHE	pag. 330
INDICE / INDEX	pag. 332
LAVABO	pag. 336
BIDET	pag. 340
DOCCIA INCASSO	pag. 340
DEVIATORI INCASSO	pag. 340
DOCCIA ESTERNO	pag. 341
VASCA	pag. 342
BAGNO COMPLEMENTI	pag. 343



ZEHN

PREZZO FINITURE

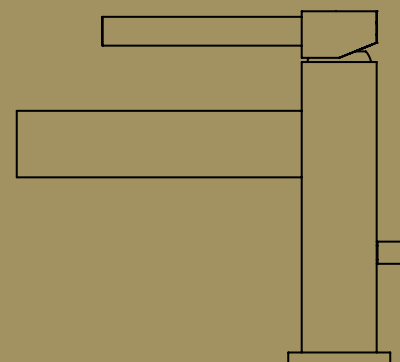
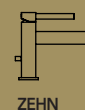
Calcola il prezzo di listino (IVA esclusa) delle finiture diverse dal cromato, consultando la seguente tabella.

Moltiplicare il **PREZZO LISTINO** per il **COEFFICIENTE MOLTIPLICATORE** della finitura scelta, arrotondando per difetto il prezzo ottenuto (eliminare i centesimi).
ESEMPIO per ordinare art. 7505/N in finitura dorato: codice **04-7505/N**

PRICE FINISHES

Include the list price (excluding VAT) of different finishes from chrome, consulting the following table. **Multiply the PRICE LIST MULTIPLIER COEFFICIENT** of the chosen finish, **reducing the price obtained by deleting the centesim.**

EXAMPLE to order art. 7505/N gold finish: code **04-7505/N**

COMPOSIZIONE CODICE PER ORDINARE ARTICOLO IN FINITURA



CODICE FINITURA
FINISH CODE

CODICE ARTICOLO
ITEM NUMBER

FINITURE DI SERIE / STANDARD FINISHES

CODICE CODE	DESCRIZIONE FINITURA FINISH DESCRIPTION	MOLTIPLICATORE MULTIPLIER
01-	cromato / chrome	PREZZO LISTINO*
71-	oro opaco / mat gold	x

FINITURE A RICHIESTA / ON REQUEST FINISHES

CODICE CODE	DESCRIZIONE FINITURA FINISH DESCRIPTION	MOLTIPLICATORE MULTIPLIER
02-	cromo/oro / chrome/gold	x
03-	oro/argento / gold/silver	x
04-	dorato / gold	x
05-	bronzo satinato / satin bronze	x
06-	rame vecchio / old copper	x
07-	vecchio argento / old silver	x
08-	canna di fucile / gun barrel	x
10-	verderame / verdigris	x
11-	nero antracite / anthracite black	x
12-	ottone lucido / polished brass	x
13-	ottone naturale / natural brass	x
14-	bianco / white	x
19-	nero / black	x
28-	nickel satinato / satin nickel	x

FINITURE A RICHIESTA / ON REQUEST FINISHES

CODICE CODE	DESCRIZIONE FINITURA FINISH DESCRIPTION	MOLTIPLICATORE MULTIPLIER
30-	nickel lucido / polished nickel	x
33-	cromo satinato / satin chrome	x
34-	cromo spazzolato / brushing chrome	x
35-	nickel spazzolato / brushing nickel	x
56-	avorio / ivory	x
57-	azzurro / light blue	x
58-	verdino / light green	x
59-	marrone / brown	x
60-	arancio / orange	x
61-	rosso / red	x
66-	bianco opaco / mat white	x
67-	nero opaco / mat black	x
68-	rame opaco / mat copper	x
69-	argento opaco / mat silver	x
72-	bronzo opaco / mat bronze	x
75-	dorato spazzolato / brushing gold	x
87-	oro rosa / pink gold	x
88-	ottone sisal / sisal brass	x

*PREZZO DI LISTINO / PRICE LIST

*NON REALIZZABILE / NOT MADE

ATTENZIONE! 13-OTTONE NATURALE e 88-OTTONE SISAL: finiture non protette che antichizzano naturalmente ossidando a contatto con l'umidità atmosferica.
WARNING! 13-NATURAL BRASS and 88-SISAL BRASS: unprotected finishes that naturally oxidise in contact with atmospheric humidity.

PROGETTO SU MISURA: RICHIESTE SPECIALI

I tecnici di Bellosta Rubinetterie sono, inoltre, a disposizione di architetti e designers, per offrire un servizio esclusivo: personalizzazioni di elementi in funzione di specifiche richieste estetiche o problematiche legate a vincoli progettuali, verifica della fattibilità attraverso opportuni studi CAD e sviluppo del disegno tecnico del prodotto speciale richiesto.

Per informazioni e richieste **PROGETTI SU MISURA:**
 ufficiotecnico@bellostarubinetterie.com



PROGETTO SU MISURA: SPECIAL REQUESTS

Engineers Bellosta Rubinetterie are also available to architects and designers, to offer an exclusive service: customizations of items according to specific aesthetic requirements or issues related to design constraints, verification of the feasibility studies and development through appropriate CAD technical design the required special product. For information and requests "SU MISURA" PROJECTS:
 ufficiotecnico@bellostarubinetterie.com

CONSIGLIO TECNICO

Tutti i miscelatori della collezione ZEHN vengono collaudati nel loro funzionamento al momento dell'assemblaggio. Per garantire la durata delle cartucce nel tempo, si consiglia di spurgare bene l'impianto idraulico prima del montaggio (per rimuovere eventuali detriti) e di installare rubinetti sottolavabo con filtro (art. 0920 o 020)

N.B.: Qualora il piano lavabo avesse uno spessore superiore a 5 cm specificare la misura al momento dell'ordine.

TECHNICAL ADVICE

All mixers of the ZEHN collection are perfectly tested. To guarantee the perfect functionality of the cartridge for a long time, we advise to clean the sanitary plant before installing the mixer. Moreover we advise to install angle valve with filter (art. 0920 or 020).

Attention: If the lavatory top is more than cm 5 hick, please point it out when placing the order.

FORATURA DEI PIANI SANITARI

I miscelatori lavabo/bidet monoforo prevedono un foro di diametro 35 mm nel piano sanitario.

MONOFORO >>

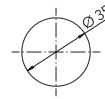

DRILLING PLANS HEALTH

The sink / hole bidet mixers provide a hole diameter of 35 mm in the health plan.

SCHEMA FUNZIONAMENTO DEVIATORI INCASSO 2/3/4 USCITE

Questi deviatori non hanno funzione di chiusura. Ruotando verso destra o sinistra si attivano le uscite. Tra 2 uscite adiacenti durante la rotazione diminuisce la portata dell'uscita iniziale ed incrementa quella della successiva. In posizione intermedia sono entrambe attive a pari portata.



2 OUT



3 OUT

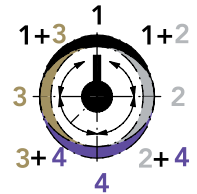

4 OUT

SCHEME OPERATION SWITCHES FLUSH OUTPUT 2/3/4

These diverters have not closing function. By turning to the right or left activates the outputs. Between two adjacent outputs during the rotation decreases the initial output flow and increases that of the next. In position intermediate are both active at the same flow rate.

EROGAZIONE D'ACQUA

La collezione STRESA utilizza di serie erogazione con getto areato; la manutenzione avviene come da schema.

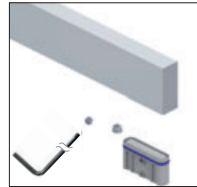

WATER SUPPLY

The collection STRESA is supplied by aerated water jet, the maintenance is made like scheme.

LEGENDA SIMBOLI

**ACCESSORI
ACCESSORIES**



SCARICO C/TAPPO A PRESSIONE

WASTE WITH PRESSURE CAP

**RICAMBI IMMEDIATI
IMMEDIATE PARTS**



CARTUCCIA CARTRIDGE



CARTUCCIA DEVIATRICE DIVERTER CARTRIDGE



CARTUCCIA TERMOSTATICA THERMOSTATIC CARTRIDGE



DEVIATORE DIVERTER



VITONE CERAMICO CERAMIC VALVE



AERATORE TONDO ROUND AERATOR



VITONE TRADIZIONALE TRADITIONAL VALVE



AERATORE PIATTO FLAT AERATOR

LAVABO

7505/N pag. 336
 MISCELATORE LAVABO MONOFORO
 BASIN MIXER



7505/N/S pag. 336
 MISCELATORE LAVABO MONOFORO
 BASIN MIXER



7505/NP pag. 336
 MISCELATORE LAVABO MONOFORO BOCCA
 PROLUNGATA
 BASIN MIXER WITH EXTENDED SPOUT



7505/NP/S pag. 336
 MISCELATORE LAVABO MONOFORO BOCCA
 PROLUNGATA
 BASIN MIXER WITH EXTENDED SPOUT



7505/NPA pag. 336
 MISCELATORE LAVABO MONOFORO BOCCA
 EXTRAPROLUNGATA
 BASIN MIXER WITH EXTRA EXTENDED SPOUT



7505/NPA/S pag. 337
 MISCELATORE LAVABO MONOFORO BOCCA
 EXTRAPROLUNGATA
 BASIN MIXER WITH EXTRA EXTENDED SPOUT



754018, 754019 pag. 337
 PROLUNGHE MISCELATORE LAVABO
 EXTENSIONS BASIN MIXER



altezza mm 100 / high 100 mm: 754018
 altezza mm 150 / high 150 mm: 754019

7505/N4/A pag. 337
 MISCELATORE LAVABO MONOFORO BOCCA
 GIREVOLE
 BASIN MIXER SWINGING SPOUT



7505/N4/A/S pag. 337
 MISCELATORE LAVABO MONOFORO BOCCA
 GIREVOLE
 BASIN MIXER SWINGING SPOUT



7505/N4/B pag. 337
 MISCELATORE LAVABO MONOFORO BOCCA
 GIREVOLE PROLUNGATA
 BASIN MIXER EXTENDED SWINGING SPOUT



7505/N4/B/S pag. 338
 MISCELATORE LAVABO MONOFORO BOCCA
 GIREVOLE PROLUNGATA
 BASIN MIXER EXTENDED SWINGING SPOUT



754020, 754021 pag. 338
 PROLUNGHE MISCELATORE LAVABO
 EXTENSIONS BASIN MIXER

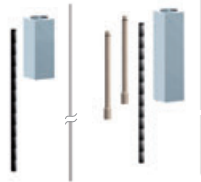

altezza mm 100 / high 100 mm: 754020
 altezza mm 150 / high 150 mm: 754021

7505/N3/E + 894001 pag. 338
 MISCELATORE LAVABO DA PARETE
 WALL BASIN MIXER



parti esterne / external parts: 7505/N3/E
 parte incasso / built-in part: 894001



7505/N3/1/E + 894001 pag. 338
 MISCELATORE LAVABO DA PARETE BOCCA
 PROLUNGATA
 WALL BASIN MIXER EXTENDED SPOUT



parti esterne / external parts: 7505/N3/1/E
 parte incasso / built-in part: 894001



7505/N3/2/E + 894001 pag. 338
 MISCELATORE LAVABO DA PARETE BOCCA
 EXTRAPROLUNGATA
 WALL BASIN MIXER EXTRA EXTENDED SPOUT



parti esterne / external parts: 7505/N3/2/E
 parte incasso / built-in part: 894001

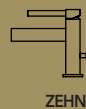

7505/R/A pag. 339
 MISCELATORE REMOTO
 REMOTE MIXER

LAVABO



7505/R/B/E + 104033 pag. 339

MISCELATORE INCASSO REMOTO
BUILT-IN REMOTE MIXER

parti esterne / external parts: 7505/R/B/E
parte incasso / built-in part: 104033



7505/N1/A pag. 339

BOCCA LAVABO MONOFORO
WASH SPOUT



7505/N1/B pag. 339

BOCCA LAVABO MONOFORO MEDIUM
"MEDIUM SIZE" WASH SPOUT



7505/N1/C pag. 339

BOCCA LAVABO MONOFORO ALTA
HIGHER WASH SPOUT

BIDET



7507/N pag. 340

MISCELATORE BIDET MONOFORO
BIDET MIXER



7507/N2 pag. 340

MISCELATORE BIDET MONOFORO BOCCA
GIREVOLE
BIDET MIXER SWINGING SPOUT

DOCCIA INCASSO



7521/E + 104018 pag. 340

MISCELATORE INCASSO
BUILT-IN MIXER

parti esterne / external parts: 7521/E
parte incasso / built-in part: 104018



7500/E + 104002 pag. 340

MISCELATORE INCASSO C/DEVIATORE 2 USCITE
BUILT-IN MIXER WITH DIVETER 2 OUT

parti esterne / external parts: 7500/E
parte incasso / built-in part: 104002

DEVIATORI INCASSO



7503/2/1/E + 914016 pag. 340

DEVIATORE INCASSO 2 USCITE
BUILT-IN DIVERTER 2 OUT

parti esterne / external parts: 7503/2/1/E
parte incasso / built-in part: 914016



7503/3/1/E + 034127 pag. 341

DEVIATORE INCASSO 3 USCITE
BUILT-IN DIVERTER 3 OUT

parti esterne / external parts: 7503/3/1/E
parte incasso / built-in part: 034127

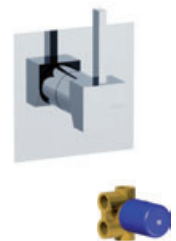

7503/4/1/E + 034128 pag. 341

DEVIATORE INCASSO 4 USCITE
BUILT-IN DIVERTER 4 OUT

parti esterne / external parts: 7503/4/1/E
parte incasso / built-in part: 034128

DOCCIA INCASSO TERMOSTATICO



0912/H/P/E + 484020 pag. 212*

MISCELATORE TERMOSTATICO INCASSO 1 USCITA
THERMOSTATIC BUILT-IN MIXER 1 OUT

parti esterne / external parts: 0912/H/P/E
parte incasso / built-in part: 484020



0912/2/P/E + 484021 pag. 212*

MISCELATORE TERMOSTATICO INCASSO C/DEV 2 USCITE
BUILT-IN THERMOSTATIC MIXER WITH DIVERTER 2 OUT

parti esterne / external parts: 0912/2/P/E
parte incasso / built-in part: 484021



0912/3/P/E + 484022 pag. 212*

MISCELATORE TERMOSTATICO INCASSO C/DEV 3 USCITE
BUILT-IN THERMOSTATIC MIXER WITH DIVERTER 3 OUT

parti esterne / external parts: 0912/3/P/E
parte incasso / built-in part: 484022



0912/4/P/E + 484023 pag. 212*

MISCELATORE TERMOSTATICO INCASSO C/DEV 4 USCITE
BUILT-IN THERMOSTATIC MIXER WITH DIVERTER 4 OUT

parti esterne / external parts: 0912/4/P/E
parte incasso / built-in part: 484023

* ABBINAMENTO CONSIGLIATO: PER PREZZI E SCHEDE TECNICHE, VEDI RIFERIMENTO PAGINA LISTINO REVIVRE

* RECOMMENDED COMBINATION: FOR PRICES AND TECHNICAL DETAILS, LOOK AT PAGE WITH REFERENCE REVIVRE PRICE

DOCCIA ESTERNO

7509/1 pag. **341**
 MISCELATORE DOCCIA ESTERNO
 EXTERNAL SHOWER MIXER



7509/4 pag. **341**
 MISCELATORE DOCCIA ESTERNO C/STELO
 EXTERNAL SHOWER MIXER WITH PIPE



7509/5/1 pag. **342**
 MISCELATORE DOCCIA ESTERNO C/STELO
 COMPLETO
 EXTERNAL SHOWER MIXER WITH COMPLETE PIPE



DOCCIA COMPLEMENTI

7503/1/A pag. **136***
 SUPPORTO DOCCIA COMPLETO
 FULL SHOWER SUPPORT



7503/1 pag. **137***
 SUPPORTO DOCCIA DUPLEX COMPLETO
 FULL SHOWER SUPPORT WITH DUPLEX



7530 pag. **144***
 SALISCENDI COMPLETO C/PRESA D'ACQUA
 COMPLETE WALL PIPE WITH WATER CONNECTION



6530/1 pag. **148***
 ASTA SALISCENDI
 WALL PIPE



6513/4 pag. **150***
 STELO DOCCIA
 ROD SHOWER



7513/5/1 pag. **152***
 CURVA PRESA ACQUA C/STELO COMPLETO
 CURVE WATER CONNECTOR WITH COMPLETE ROD



VASCA

7501/NA pag. **342**
 MISCELATORE VASCA ESTERNO
 EXTERNAL BATH MIXER



7501/N2/A pag. **342**
 MISCELATORE PER BORDO VASCA
 BATH RIM MIXER



7501/N2/P/A pag. **342**
 MISCELATORE PER BORDO VASCA C/PIASTRA
 BATH RIM MIXER ON PLATE



7501/20/A pag. **342**
 MISCELATORE PER BORDO VASCA S/BOCCA
 BATH RIM MIXER WITHOUT SPOUT



7501/20/P/A pag. **343**
 MISCELATORE PER BORDO VASCA C/PIASTRA S/
 BOCCA
 BATH RIM MIXER WITHOUT SPOUT ON PLATE



7501/N4/A/E + 734012 pag. **343**
 MISCELATORE VASCA A PAVIMENTO
 FLOOR BATH MIXER



parti esterne / external parts: 7501/N4/A/E
 parte incasso / built-in part: 734012

VASCA



7501/N4/1A/E + 734012 pag. 343

MISCELATORE VASCA A PAVIMENTO BOCCA
PROLUNGATA
FLOOR BATH MIXER EXTENDED SPOUT



parti esterne / external parts: 7501/N4/1A/E
parte incasso / built-in part: 734012

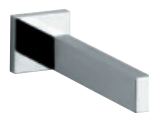

7503/N pag. 343

BOCCA VASCA DA PARETE
WALL BATH SPOUT

BAGNO COMPLEMENTI



7508/E + 054025 o 054026 pag. 343

RUBINETTO D'ARRESTO 1/2"
BUILT-IN STOP COCK 1/2"



parti esterne / external parts: 7508/E
parte incasso / built-in part: 054025 DX / 054025 SX



7508/E + 054027 o 054028 pag. 344

RUBINETTO D'ARRESTO 3/4"
BUILT-IN STOP COCK 3/4"



parti esterne / external parts: 7508/E
parte incasso / built-in part: 054027 DX / 054028 SX



7540/E + 884053 pag. 344

PASSO RAPIDO 3/4"
BUILT-IN RAPID FLOW COCK 3/4"



parti esterne / external parts: 7540/E
parte incasso / built-in part: 884053



7540/E + 884054 pag. 344

PASSO RAPIDO 1"
BUILT-IN RAPID FLOW COCK 1"



parti esterne / external parts: 7540/E
parte incasso / built-in part: 884054



7532/2/E + 035212 pag. 344

SARACINESCA
GATE VALVE



parti esterne / external parts: 7532/2/E
parte incasso / built-in part: 035212

B-TRONIC - RUBINETTI ELETTRONICI



7505/N/S/EL pag. 605

MISCELATORE CON ATTIVATORE INFRAROSSO
LAVABO
BASIN MIXER WITH INFRARED ACTIVATOR

7505/N

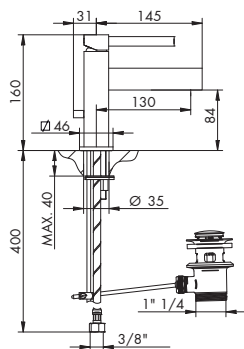

MISCELATORE LAVABO MONOFORO

- > cartuccia tradizionale
- > interasse bocca 130
- > flessibili di alimentazione
- > con scarico

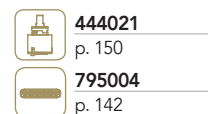

CROMATO

01-7505/N

ALTRE FINITURE

XX-7505/N

x M*

7505/N/S

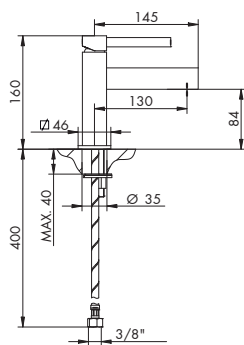

MISCELATORE LAVABO MONOFORO

- > cartuccia tradizionale
- > interasse bocca 130
- > flessibili di alimentazione
- > senza scarico

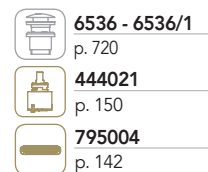

CROMATO

01-7505/N/S

ALTRE FINITURE

XX-7505/N/S

x M*

7505/NP

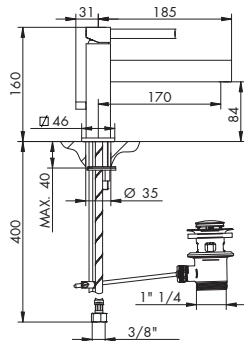

MISCELATORE LAVABO MONOFORO BOCCA PROLUNGATA

- > cartuccia tradizionale
- > interasse bocca 170
- > flessibili di alimentazione
- > con scarico

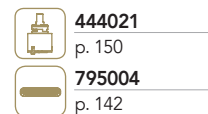

CROMATO

01-7505/NP

ALTRE FINITURE

XX-7505/NP

x M*

7505/NP/S

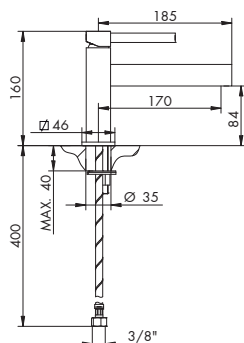

MISCELATORE LAVABO MONOFORO BOCCA PROLUNGATA

- > cartuccia tradizionale
- > interasse bocca 170
- > flessibili di alimentazione
- > senza scarico

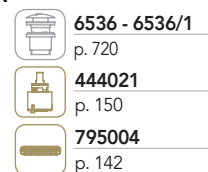

CROMATO

01-7505/NP/S

ALTRE FINITURE

XX-7505/NP/S

x M*

7505/NPA

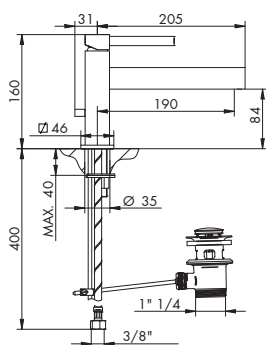

MISCELATORE LAVABO MONOFORO BOCCA

EXTRA-PROLUNGATA

- > cartuccia tradizionale
- > interasse bocca 190
- > flessibili di alimentazione
- > con scarico



CROMATO

01-7505/NPA

ALTRE FINITURE

XX-7505/NPA

x M*

7505/NPA/S

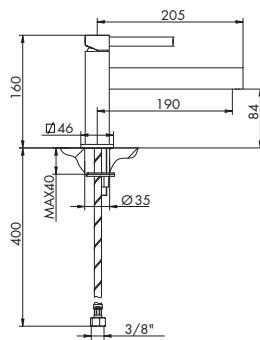
MISCELATORE LAVABO MONOFORO BOCCA
EXTRAPROLUNGATA

- > cartuccia tradizionale
- > interasse bocca 190
- > flessibili di alimentazione
- > senza scarico

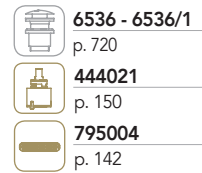

CROMATO
01-7505/NPA/S

ALTRE FINITURE
XX-7505/NPA/S

x M*

754018 | 754019



PROLUNGHE MISCELATORE LAVABO

- > 34 X 34 mm
- > altezza 100 mm, 150 mm

CROMATO
01-754018 100 mm
01-754019 150 mm

ALTRE FINITURE
XX-754018 100 mm x M*
XX-754019 150 mm x M*

7505/N4/A

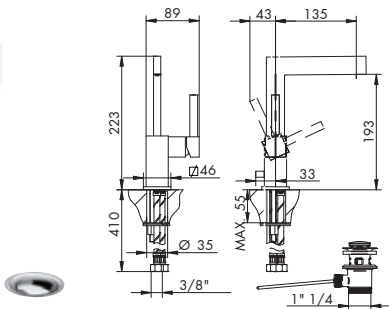

MISCELATORE LAVABO MONOFORO BOCCA GIREVOLE

- > cartuccia tradizionale
- > interasse bocca 135
- > bocca girevole 45° dx 45° sx
- > flessibili di alimentazione
- > con scarico

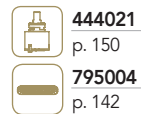

CROMATO
01-7505/N4/A

ALTRE FINITURE
XX-7505/N4/A

x M*

7505/N4/A/S

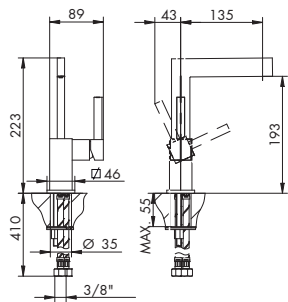

MISCELATORE LAVABO MONOFORO BOCCA GIREVOLE

- > cartuccia tradizionale
- > interasse bocca 135
- > bocca girevole 45° dx 45° sx
- > flessibili di alimentazione
- > senza scarico

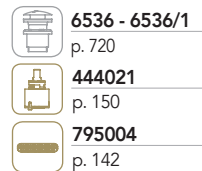

CROMATO
01-7505/N4/A/S

ALTRE FINITURE
XX-7505/N4/A/S

x M*

7505/N4/B

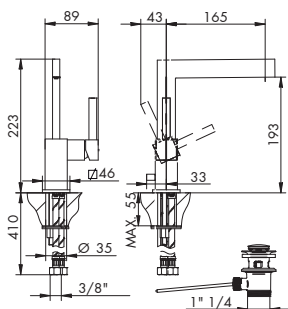
MISCELATORE LAVABO MONOFORO BOCCA GIREVOLE
PROLUNGATA

- > cartuccia tradizionale
- > interasse bocca 165
- > bocca girevole 45° dx 45° sx
- > flessibili di alimentazione
- > con scarico

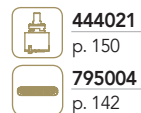

CROMATO
01-7505/N4/B

ALTRE FINITURE
XX-7505/N4/B

x M*

7505/N4/B/S

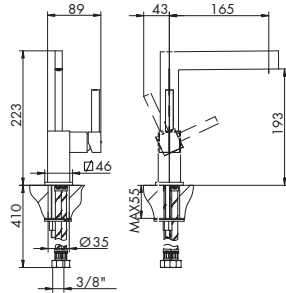

MISCELATORE LAVABO MONOFORO BOCCA GIREVOLE
PROLUNGATA

- > cartuccia tradizionale
- > interasse bocca 165
- > bocca girevole 45° dx 45° sx
- > flessibili di alimentazione
- > senza scarico

	6536 - 6536/1	p. 720
	444021	p. 150
	795004	p. 142

CROMATO
01-7505/N4/B/S

ALTRE FINITURE
XX-7505/N4/B/S x M*

754020 | 754021

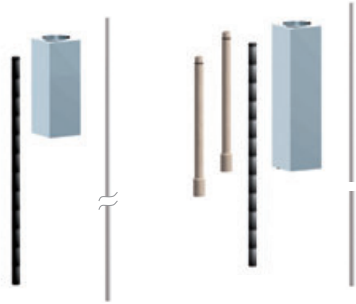

PROLUNGHE MISCELATORE LAVABO

- > 37 X 37 mm
- > altezza 100 mm, 150 mm

CROMATO	
01-754020	100 mm
01-754021	150 mm

ALTRE FINITURE	
XX-754020	100 mm x M*
XX-754021	150 mm x M*

7505/N3/E + 894001

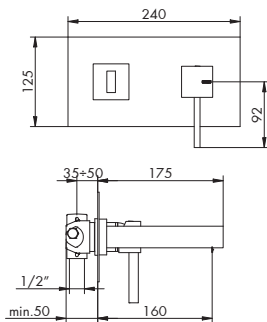

MISCELATORE LAVABO DA PARETE

- > cartuccia tradizionale
- > interasse bocca 160
- > piastra unica
- > ingressi da 1/2"
- > senza scarico

	6536 - 6536/1	p. 720
	025002	p. 149
	795004	p. 142

PARTI ESTERNE - CROMATO
01-7505/N3/E
PARTE INCASSO
01-894001 info pag. 34
PREZZO TOTALE

PARTI ESTERNE - ALTRE FINITURE
XX-7505/N3/E x M*

7505/N3/1/E + 894001

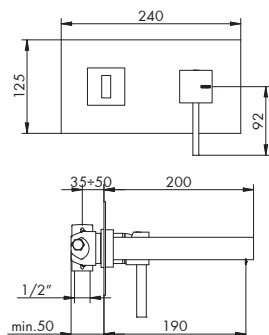

MISCELATORE LAVABO DA PARETE BOCCA
PROLUNGATA

- > cartuccia tradizionale
- > interasse bocca 185
- > piastra unica
- > ingressi da 1/2"
- > senza scarico

	6536 - 6536/1	p. 720
	025002	p. 149
	795004	p. 142

PARTI ESTERNE - CROMATO
01-7505/N3/1/E
PARTE INCASSO
01-894001 info pag. 34
PREZZO TOTALE

PARTI ESTERNE - ALTRE FINITURE
XX-7505/N3/1/E x M*

7505/N3/2/E + 894001

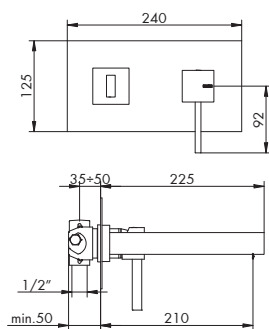

MISCELATORE LAVABO DA PARETE BOCCA
EXTRAPROLUNGATA

- > cartuccia tradizionale
- > interasse bocca 210
- > piastra unica
- > ingressi da 1/2"
- > senza scarico

	6536 - 6536/1	p. 720
	025002	p. 149
	795004	p. 142

PARTI ESTERNE - CROMATO
01-7505/N3/2/E
PARTE INCASSO
01-894001 info pag. 34
PREZZO TOTALE

PARTI ESTERNE - ALTRE FINITURE
XX-7505/N3/2/E x M*

7505/R/A

MISCELATORE REMOTO

- > cartuccia tradizionale
- > flessibili di alimentazione
- > senza scarico

 6536 - 6536/1
p. 720

 025002
p. 149

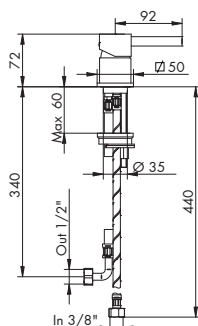

CROMATO

01-7505/R/A

ALTRE FINITURE

XX-7505/R/A

x M*

7505/R/B/E + 104033

MISCELATORE INCASSO REMOTO

- > cartuccia tradizionale
- > ingressi da 1/2"
- > uscita superiore
- > senza scarico

 6536 - 6536/1
p. 720

 025002
p. 149

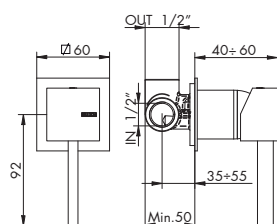

PARTI ESTERNE - CROMATO

01-7505/R/B/E

PARTE INCASSO

01-104033 info pag. 32

PREZZO TOTALE

PARTI ESTERNE - ALTRE FINITURE

XX-7505/R/B/E

x M*

7505/N1/A

BOCCA LAVABO MONOFORO

- > cartuccia tradizionale
- > interasse bocca 200
- > bocca girevole 45° dx 45° sx
- > flessibili di alimentazione
- > senza scarico

 6536 - 6536/1
p. 720

 795004
p. 142

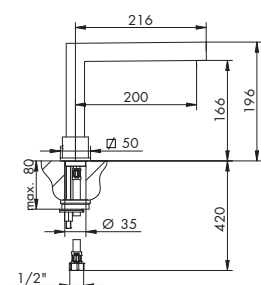

CROMATO

01-7505/N1/A

ALTRE FINITURE

XX-7505/N1/A

x M*

7505/N1/B

BOCCA LAVABO MONOFORO MEDIUM

- > cartuccia tradizionale
- > interasse bocca 200
- > bocca girevole 45° dx 45° sx
- > flessibili di alimentazione
- > senza scarico

 6536 - 6536/1
p. 720

 795004
p. 142

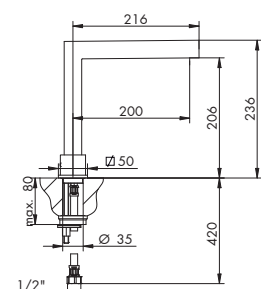

CROMATO

01-7505/N1/B

ALTRE FINITURE

XX-7505/N1/B

x M*

7505/N1/C

BOCCA LAVABO MONOFORO ALTA

- > cartuccia tradizionale
- > interasse bocca 200
- > bocca girevole 45° dx 45° sx
- > flessibili di alimentazione
- > senza scarico

 6536 - 6536/1
p. 720

 795004
p. 142

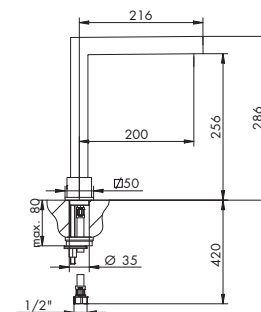

CROMATO

01-7505/N1/C

ALTRE FINITURE

XX-7505/N1/C

x M*

ACCESSORI

 SCARICO C/TAPPO A PRESSIONE

RICAMBI IMMEDIATI

 CARTUCCIA

 AERATORE PIATTO

XX = CODICE FINITURA RICHIESTA: per identificare codice corretto vedi pag. 330
M* = MOLTIPLICATORE: per calcolare il prezzo delle altre finiture vedi tabella pag. 330

7507/N

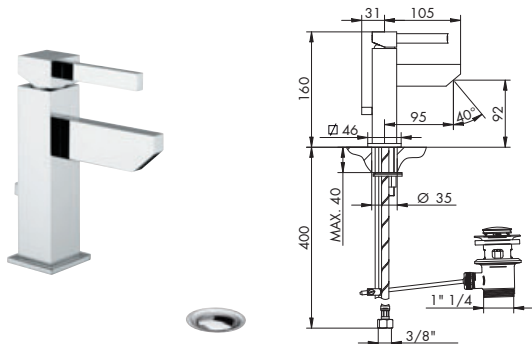

MISCELATORE BIDET MONOFORO

- > cartuccia tradizionale
- > interasse bocca 95
- > flessibili di alimentazione
- > con scarico

	444021
	p. 150
	755129
	p. 141

CROMATO

01-7507/N

ALTRE FINITURE

XX-7507/N

x M*

7507/N2

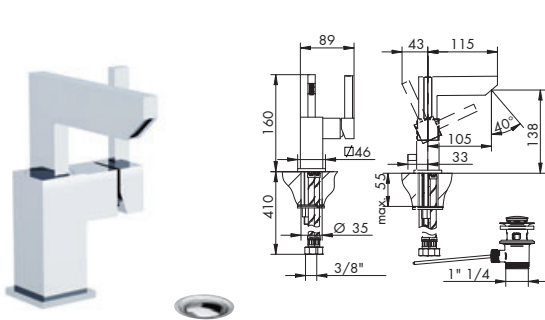

MISCELATORE BIDET MONOFORO LEVA LATERALE

BOCCA GIREVOLE

- > cartuccia tradizionale
- > interasse bocca 105
- > bocca girevole 45° dx 45° sx
- > flessibili di alimentazione
- > con scarico

	444021
	p. 150
	755129
	p. 141

CROMATO

01-7507/N2

ALTRE FINITURE

XX-7507/N2

x M*

7521/E + 104018

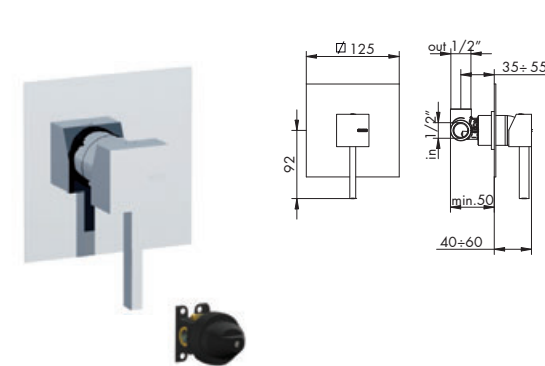

MISCELATORE INCASSO

- > cartuccia tradizionale
- > attacchi da 1/2"
- > uscita superiore
- > incasso con B-Box

	025002
	p. 149

PARTI ESTERNE - CROMATO

01-7521/E

PARTI ESTERNE - ALTRE FINITURE

XX-7521/E

x M*

PARTE INCASSO

01-104018 info pag. 36

PREZZO TOTALE

7500/E + 104002

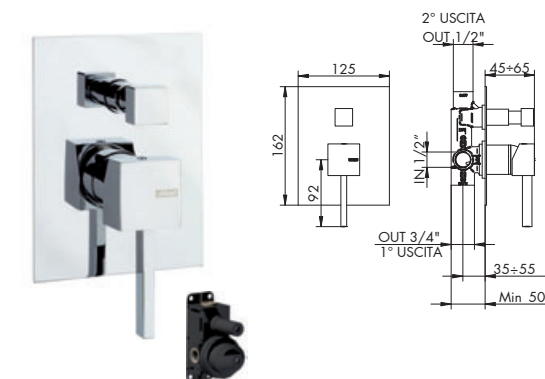

MISCELATORE INCASSO C/DEVIATORE 2 USCITE

- > cartuccia tradizionale
- > deviatore a pressione 2 uscite c/ritorno automatico e blocco meccanico basse pressioni
- > attacchi da 1/2"
- > uscita principale inferiore da 3/4"
- > incasso con B-Box

	025002
	p. 149
	105029
	p. 131

PARTI ESTERNE - CROMATO

01-7500/E

PARTI ESTERNE - ALTRE FINITURE

XX-7500/E

x M*

PARTE INCASSO

01-104002 info pag. 37

PREZZO TOTALE

7503/2/1/E + 914016

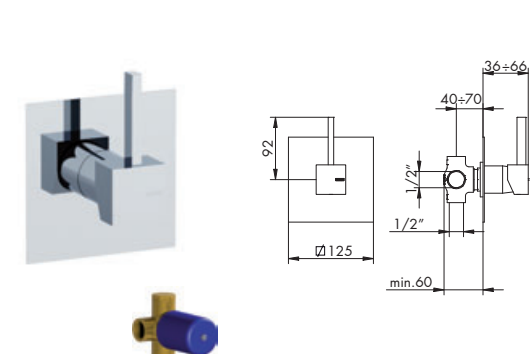

DEVIATORE INCASSO 2 USCITE

- > deviatore a dischi ceramici 2 uscite senza chiusura
- > attacchi da 1/2"

	635010
	p. 131
	035346 fino 9.2017
	p. 131

PARTI ESTERNE - CROMATO

01-7503/2/1/E

PARTI ESTERNE - ALTRE FINITURE

XX-7503/2/1/E

x M*

PARTE INCASSO

914016 info pag. 38

PREZZO TOTALE

7503/3/1/E + 034127

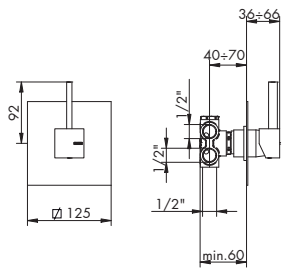

DEVIATORE INCASSO 3 USCITE

> deviatore a dischi ceramici 3 uscite senza chiusura
> attacchi da 1/2"



635011
p. 131



035345 fino 9.2017
p. 131

PARTI ESTERNE - CROMATO

01-7503/3/1/E

PARTI ESTERNE - ALTRE FINITURE

XX-7503/3/1/E

x M*

PARTE INCASSO

034127 info pag. 38

PREZZO TOTALE

7503/4/1/E + 034128

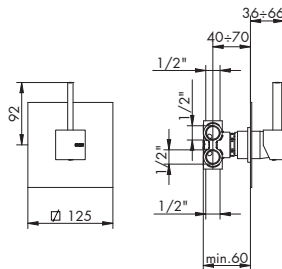

DEVIATORE INCASSO 4 USCITE

> deviatore a dischi ceramici 4 uscite senza chiusura
> attacchi da 1/2"



635012
p. 131



035344 fino 9.2017
p. 131

PARTI ESTERNE - CROMATO

01-7503/4/1/E

PARTI ESTERNE - ALTRE FINITURE

XX-7503/4/1/E

x M*

PARTE INCASSO

034128 info pag. 38

PREZZO TOTALE

I DOCCIA INCASSO TERMOSTATICO CONSIGLIATI SONO PRESENTI SU LISTINO REVIVRE

- 0912/H/P/E + 484020
- 0912/2/P/E + 484021
- 0912/3/P/E + 484022
- 0912/4/P/E + 484023

I DOCCIA COMPLEMENTI CONSIGLIATI SONO PRESENTI SU LISTINO REVIVRE

- 7503/1/A 6513/4
- 7503/1 7513/5/1
- 7530
- 6530/1

7509/1

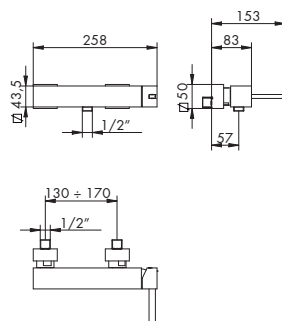

MISCELATORE DOCCIA ESTERNO

> cartuccia tradizionale
> senza set doccia
> attacchi da 1/2"



025002
p. 149

CROMATO

01-7509/1

ALTRE FINITURE

XX-7509/1

x M*

7509/4

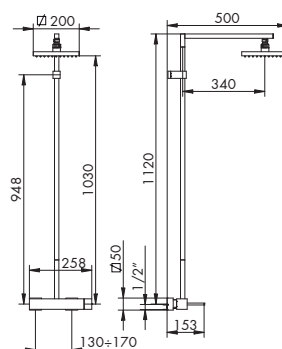

MISCELATORE DOCCIA ESTERNO C/STELO

> cartuccia tradizionale
> stelo quadro fisso
> soffione orientabile 200x200 in ABS con anticalcare
> ingresso inferiore da 1/2"
> per finiture diverse da cromo soffione in metallo



025002
p. 149

CROMATO

01-7509/4

ALTRE FINITURE

XX-7509/4

x M*

RICAMBI IMMEDIATI



XX = CODICE FINITURA RICHIESTA: per identificare codice corretto vedi pag. 330
M* = MOLTIPLICATORE: per calcolare il prezzo delle altre finiture vedi tabella pag. 330



7509/5/1

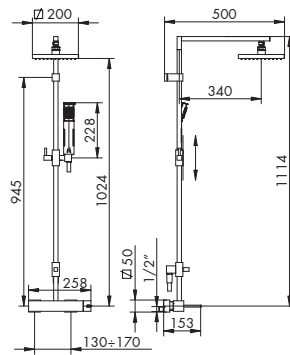

MISCELATORE DOCCIA ESTERNO C/STELO COMPLETO

- > cartuccia tradizionale
- > stelo quadro fisso
- > deviatore a trazione con ritorno automatico e blocco meccanico per basse pressioni
- > soffione orientabile 200x200 in ABS c/anticalcare
- > flessibile PVC L 150 cm
- > presa acqua inferiore da 1/2"
- > doccetta monogetto rettangolare in ABS c/anticalcare, per finiture diverse da cromo doccetta quadra e soffione in metallo

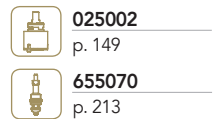

CROMATO
01-7509/5/1

ALTRE FINITURE
XX-7509/5/1

x M*

7501/NA

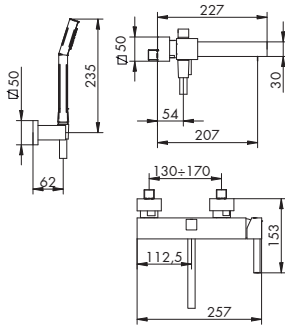

MISCELATORE VASCA ESTERNO

- > cartuccia tradizionale
- > interasse bocca 207
- > deviatore a trazione c/ritorno automatico e blocco meccanico basse pressioni
- > flessibile in PVC 150 cm
- > supporto a parete fisso
- > attacchi da 1/2"
- > doccetta monogetto rettangolare in ABS c/anticalcare, per finiture diverse da cromo doccetta quadra in metallo

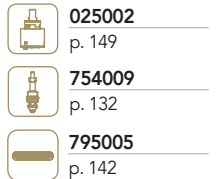

CROMATO
01-7501/NA

ALTRE FINITURE
XX-7501/NA

x M*

7501/N2/A

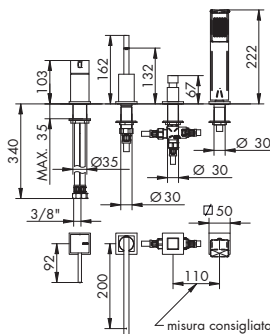

MISCELATORE PER BORDO VASCA

- > cartuccia tradizionale
- > interasse bocca 200
- > deviatore a pressione c/ritorno automatico e blocco meccanico basse pressioni
- > flessibile in PVC 150 cm > flessibili di alimentazione
- > senza scarico
- > doccetta monogetto rettangolare in ABS c/anticalcare, per finiture diverse da cromo doccetta quadra in metallo
- > PREDISPOSIZIONI per bordo vasca, art. 012/4, 012/6 e 012/7, vedi pag. 615

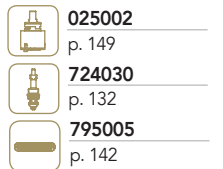

CROMATO
01-7501/N2/A

ALTRE FINITURE
XX-7501/N2/A

x M*

7501/N2/P/A

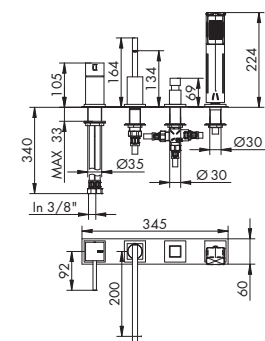

MISCELATORE PER BORDO VASCA C/PIASTRA

- > cartuccia tradizionale
- > interasse bocca 200
- > piastra unica
- > deviatore a pressione c/ritorno automatico e blocco meccanico basse pressioni
- > flessibile in PVC 150 cm > flessibili di alimentazione
- > senza scarico
- > piastra estetica interasse fori 95mm
- > doccetta monogetto rettangolare in ABS c/anticalcare, per finiture diverse da cromo doccetta quadra in metallo

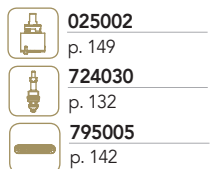

CROMATO
01-7501/N2/P/A

ALTRE FINITURE
XX-7501/N2/P/A

x M*

7501/20/A

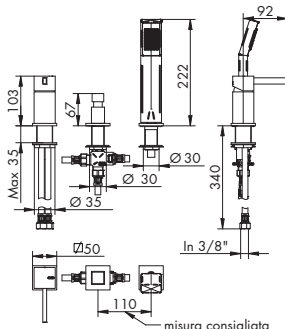

MISCELATORE PER BORDO VASCA S/BOCCA

- > cartuccia tradizionale
- > senza bocca
- > deviatore a pressione c/ritorno automatico e blocco meccanico basse pressioni
- > flessibile in PVC 150 cm > flessibili di alimentazione
- > senza scarico
- > doccetta monogetto rettangolare in ABS c/anticalcare, per finiture diverse da cromo doccetta quadra in metallo
- > PREDISPOSIZIONI per bordo vasca, art. 012/3, 012/6 e 012/7, vedi pag. 615

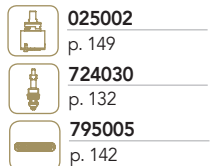

CROMATO
01-7501/20/A

ALTRE FINITURE
XX-7501/20/A

x M*

7508/E + 054027 DX o 054028 SX

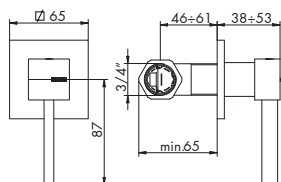

RUBINETTO D'ARRESTO 3/4"

> vitone ceramico 90°
> ingressi da 3/4"

	055001 p. 151
	055002 p. 151

PARTI ESTERNE - CROMATO	PARTI ESTERNE - ALTRE FINITURE
01-7508/E	XX-7508/E x M*
PARTE INCASSO	
054027 o 054028 info pag. 40	
PREZZO TOTALE	

7540/E + 884053

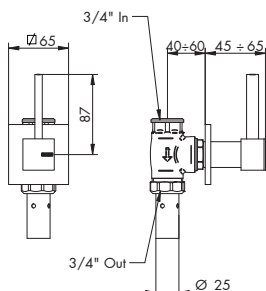
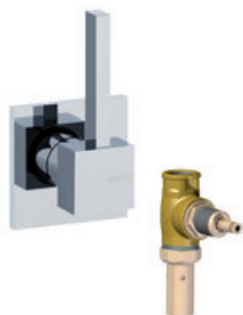

PASSO RAPIDO 3/4"

> vitone tradizionale
> abbinare a saracinesca
> ingressi da 3/4"

	884021 p. 151
--	------------------

PARTI ESTERNE - CROMATO	PARTI ESTERNE - ALTRE FINITURE
01-7540/E	XX-7540/E x M*
PARTE INCASSO	
884053 info pag. 42	
PREZZO TOTALE	

7540/E + 884054

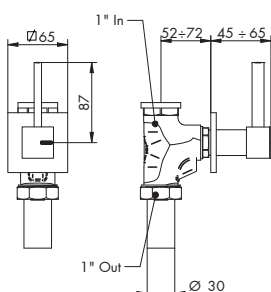

PASSO RAPIDO 1"

> vitone tradizionale
> abbinare a saracinesca
> ingressi da 1"

	884021 p. 151
--	------------------

PARTI ESTERNE - CROMATO	PARTI ESTERNE - ALTRE FINITURE
01-7540/E	XX-7540/E x M*
PARTE INCASSO	
884054 info pag. 42	
PREZZO TOTALE	

7532/2/E + 035212

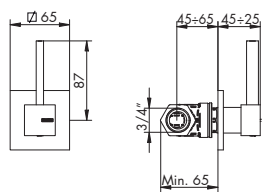

SARACINESCA

> attacchi da 3/4"

PARTI ESTERNE - CROMATO	PARTI ESTERNE - ALTRE FINITURE
01-7532/2/E	XX-7532/2/E x M*
PARTE INCASSO	
035212 info pag. 42	
PREZZO TOTALE	

