



DECOR

# PALOMA

EQB DESIGN



PALOMA



TABELLA PREZZI FINITURE	pag. W-4
INFO TECNICHE	pag. W-4
INDICE / INDEX	pag. W-6
LAVABO	pag. W-10
BIDET	pag. W-15
DOCCIA INCASSO	pag. W-15
DEVIATORI INCASSO	pag. W-15
DOCCIA ESTERNO	pag. W-16
VASCA	pag. W-17
BAGNO COMPLEMENTI	pag. W-17

**PREZZO FINITURE**

Calcola il prezzo di listino (IVA esclusa) delle finiture diverse dal cromato, consultando la seguente tabella.

Moltiplicare il **PREZZO LISTINO** per il **COEFFICIENTE MOLTIPLICATORE** della finitura scelta, arrotondando per difetto il prezzo ottenuto (eliminare i centesimi).  
**ESEMPIO** per ordinare art. 6005/1 in finitura dorato: codice **04-6005/1**

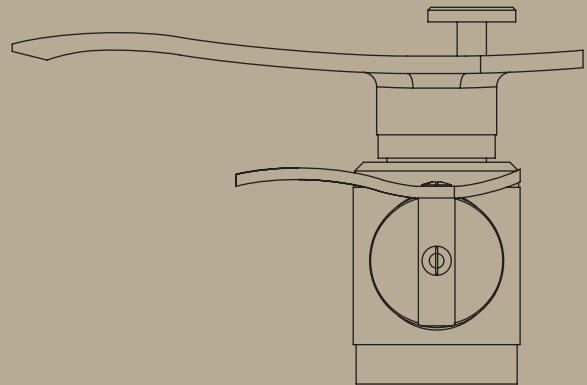
**PRICE FINISHES**

Include the list price (excluding VAT) of different finishes from chrome, consulting the following table. **Multiply the PRICE LIST MULTIPLIER COEFFICIENT** of the chosen finish, reducing the price obtained by deleting the centesim.

**EXAMPLE** to order art. 6005/1 gold finish: code **04-6005/1**

**COMPOSIZIONE CODICE PER ORDINARE ARTICOLO IN FINITURA**



**CODICE FINITURA**  
FINISH CODE

**CODICE ARTICOLO**  
ITEM NUMBER

**FINITURE DI SERIE / STANDARD FINISHES**

CODICE CODE	DESCRIZIONE FINITURA FINISH DESCRIPTION	MOLTIPLICATORE MULTIPLIER
<b>01-</b>	cromato / chrome	<b>PREZZO LISTINO°</b>
<b>02-</b>	cromo/oro / chrome/gold	<b>x</b>
<b>04-</b>	dorato / gold	<b>x</b>
<b>08-</b>	canna di fucile / gun barrel	<b>x</b>
<b>14-</b>	bianco / white	<b>x</b>
<b>19-</b>	nero / black	<b>x</b>
<b>66-</b>	bianco opaco / mat white	<b>x</b>
<b>67-</b>	nero opaco / mat black	<b>x</b>
<b>69-</b>	argento opaco / mat silver	<b>x</b>
<b>71-</b>	oro opaco / mat gold	<b>x</b>

**FINITURE A RICHIESTA / ON REQUEST FINISHES**

CODICE CODE	DESCRIZIONE FINITURA FINISH DESCRIPTION	MOLTIPLICATORE MULTIPLIER
<b>12-</b>	ottone lucido / polished brass	<b>x</b>
<b>13-</b>	ottone naturale / natural brass	<b>x</b>
<b>28-</b>	nickel satinato / satin nickel	<b>x</b>
<b>30-</b>	nickel lucido / polished nickel	<b>x</b>
<b>33-</b>	cromo satinato / satin chrome	<b>x</b>
<b>34-</b>	cromo spazzolato / brushing chrome	<b>x</b>
<b>35-</b>	nickel spazzolato / brushing nickel	<b>x</b>
<b>56-</b>	avorio / ivory	<b>NON REALIZZABILE*</b>
<b>57-</b>	azzurro / light blue	<b>NON REALIZZABILE*</b>
<b>58-</b>	verdino / light green	<b>NON REALIZZABILE*</b>
<b>59-</b>	marrone / brown	<b>NON REALIZZABILE*</b>
<b>60-</b>	arancio / orange	<b>NON REALIZZABILE*</b>
<b>61-</b>	rosso / red	<b>NON REALIZZABILE*</b>
<b>68-</b>	rame opaco / mat copper	<b>x</b>
<b>72-</b>	bronzo opaco / mat bronze	<b>x</b>
<b>75-</b>	dorato spazzolato / brushing gold	<b>x</b>
<b>87-</b>	oro rosa / pink gold	<b>x</b>
<b>88-</b>	ottone sisal / sisal brass	<b>x</b>

**FINITURE A RICHIESTA / ON REQUEST FINISHES**

CODICE CODE	DESCRIZIONE FINITURA FINISH DESCRIPTION	MOLTIPLICATORE MULTIPLIER
<b>03-</b>	oro/argento / gold/silver	<b>x</b>
<b>05-</b>	bronzo satinato / satin bronze	<b>x</b>
<b>06-</b>	rame vecchio / old copper	<b>x</b>
<b>07-</b>	vecchio argento / old silver	<b>x</b>
<b>10-</b>	verderame / verdigris	<b>NON REALIZZABILE*</b>
<b>11-</b>	nero antracite / anthracite black	<b>NON REALIZZABILE*</b>

°PREZZO DI LISTINO / PRICE LIST

\*NON REALIZZABILE / NOT MADE

**ATTENZIONE! 13-OTTONE NATURALE e 88-OTTONE SISAL: finiture non protette che antichizzano naturalmente ossidando a contatto con l'umidità atmosferica.**  
**WARNING! 13-NATURAL BRASS and 88-SISAL BRASS: unprotected finishes that naturally oxidise in contact with atmospheric humidity.**

**PROGETTO SU MISURA: RICHIESTE SPECIALI**

I tecnici di Bellosta Rubinetterie sono, inoltre, a disposizione di architetti e designers, per offrire un servizio esclusivo: personalizzazioni di elementi in funzione di specifiche richieste estetiche o problematiche legate a vincoli progettuali, verifica della fattibilità attraverso opportuni studi CAD e sviluppo del disegno tecnico del prodotto speciale richiesto.

Per informazioni e richieste **PROGETTI SU MISURA:**  
 ufficiotecnico@bellostarubinetterie.com



**progetto**  
"sumisura"

**PROGETTO SU MISURA: SPECIAL REQUESTS**

Engineers Bellosta Rubinetterie are also available to architects and designers, to offer an exclusive service: customizations of items according to specific aesthetic requirements or issues related to design constraints, verification of the feasibility studies and development through appropriate CAD technical design the required special product. For information and requests "SU MISURA" PROJECTS:  
 ufficiotecnico@bellostarubinetterie.com

**CONSIGLIO TECNICO**

Tutti i miscelatori della collezione PALOMA vengono collaudati nel loro funzionamento al momento dell'assemblaggio. Per garantire la durata delle cartucce nel tempo, si consiglia di spurgare bene l'impianto idraulico prima del montaggio (per rimuovere eventuali detriti) e di installare rubinetti sottolavabo con filtro:

art. 020 o 020/1 per i monofori, art. 020 e art. 029 (tubetti di collegamento con calotta) per i tre fori.

N.B.: Qualora il piano lavabo avesse uno spessore superiore a 2,5 cm specificare la misura al momento dell'ordine.

**TECHNICAL ADVICE**

All mixers of the PALOMA collection are perfectly tested. To guarantee the perfect functionality of the cartridge for a long time, we advise to clean the sanitary plant before installing the mixer. Moreover we advise to install angle valve with filter:

art. 020 or 020/1 for single hole mixers, art. 020 and art. 029 (pipes with nut 1/2") for three holes mixers

Attention: If the lavatory top is more than cm 2,5 hick, please point it out when placing the order.

**FORATURA DEI PIANI SANITARI**

I miscelatori lavabo/bidet monoforo prevedono un foro di diametro 35 mm nel piano sanitario. Le batterie lavabo 3 fori sono dotate di vitone ceramico destro con apertura a 1/4 di giro (90°); l'interasse consigliato è di 110 mm e foratura come da schema sottostante.

**DRILLING PLANS HEALTH**

The sink / hole bidet mixers provide a hole diameter of 35 mm in the health plan. The sink batteries 3 holes are equipped with ceramic cartridge Right-open 1/4 turn (90°); the recommended distance is 110 mm, drilling as per the diagram below.

MONOFORO >>

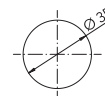

3 FORI >>

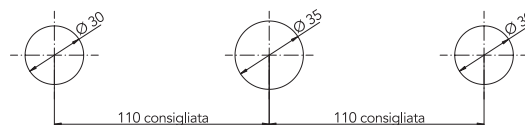

**SCHEMA FUNZIONAMENTO DEVIATORI INCASSO 2/3/4 USCITE**

Questi deviatori non hanno funzione di chiusura. Ruotando verso destra o sinistra si attivano le uscite. Tra 2 uscite adiacenti durante la rotazione diminuisce la portata dell'uscita iniziale ed incrementa quella della successiva. In posizione intermedia sono entrambe attive a pari portata.



**SCHEME OPERATION SWITCHES FLUSH OUTPUT 2/3/4**

These diverters have not closing function. By turning to the right or left activates the outputs. Between two adjacent outputs during the rotation decreases the initial output flow and increases that of the next. In position intermediate are both active at the same flow rate.

2 OUT



LAVABO



**6005** pag. W-8  
 BATTERIA LAVABO TRE FORI  
 3 HOLE BASIN



**6005/1** pag. W-8  
 GRUPPO LAVABO MONOFORO  
 1 HOLE BASIN GROUP

BIDET



**6007** pag. W-8  
 BATTERIA BIDET TRE FORI EROGAZIONE DA BORDO  
 3 HOLE BIDET WITH BOARD EROGATION



**6007/2** pag. W-8  
 GRUPPO BIDET MONOFORO  
 1 HOLE BIDET GROUP

DOCCIA INCASSO



**6000/3/E + 604013** pag. W-8  
 GRUPPO INCASSO C/DEVIATORE 2 USCITE  
 WALL MOUNTED GROUP WITH DIVERTER 2 OUT

parti esterne / external parts: 6000/3/E  
 parte incasso / built-in part: 604013

DEVIATORI INCASSO



**6003/2/E + 914016** pag. W-9  
 DEVIATORE INCASSO 2 USCITE  
 BUILT-IN DIVERTER 2 OUT

parti esterne / external parts: 6003/2/E  
 parte incasso / built-in part: 914016

DOCCIA ESTERNO



**6009/1** pag. W-9  
 GRUPPO DOCCIA ESTERNO  
 EXTERNAL SHOWER GROUP

DOCCIA COMPLEMENTI



**6003/1**  
 SUPPORTO DOCCIA DUPLEX COMPLETO  
 DUPLEX FULL SHOWER SUPPORT

VASCA



**6001/1** pag. W-9  
 GRUPPO VASCA ESTERNO  
 EXTERNAL BATH GROUP



**6001/3** pag. W-9  
 GRUPPO VASCA C/RACCORDI PER BORDO VASCA  
 EXTERNAL BATH GROUP WITH RIM CONNECTION



**6001/2** pag. W-10  
 BATTERIA PER BORDO VASCA  
 BATH RIM



**6001/20** pag. W-10  
 BATTERIA PER BORDO VASCA S/BOCCA  
 BATH RIM WITHOUT SPOUT

VASCA



6003

pag.W-10

BOCCA VASCA DA PARETE  
WALL BATH SPOUT



PALOMA

BAGNO COMPLEMENTI



6008/E + 604003 o 604004

pag.W-10

RUBINETTO D'ARRESTO 1/2"  
BUILT-IN STOP COCK 1/2"



parti esterne / external parts: 6008/E  
parte incasso / built-in part: 604003 DX o 604004 SX



6008/E + 604005 o 604006

pag.W-11

RUBINETTO D'ARRESTO 3/4"  
BUILT-IN STOP COCK 3/4"



parti esterne / external parts: 6008/E  
parte incasso / built-in part: 604005 DX o 604006 SX

6005

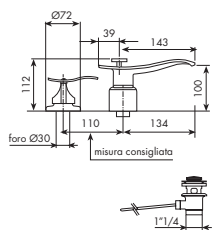

## BATTERIA LAVABO TRE FORI

- > vitone ceramico 90°
- > interasse bocca 134
- > uscita libera senza aeratore
- > senza flessibili di alimentazione
- > con scarico

 **605007**  
p. 151

 **605008**  
p. 151

## CROMATO

01-6005

€

## ALTRE FINITURE

XX-6005

€

x M\*

6005/1

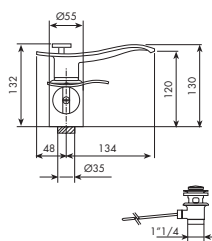

## GRUPPO LAVABO MONOFORO

- > vitone ceramico 90°
- > interasse bocca 134
- > uscita libera senza aeratore
- > flessibili di alimentazione
- > con scarico

 **605007**  
p. 151

 **605008**  
p. 151

## CROMATO

01-6005/1

€

## ALTRE FINITURE

XX-6005/1

€

x M\*

6007

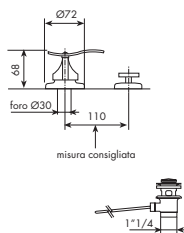

## BATTERIA BIDET TRE FORI EROGAZIONE DA BORDO

- > vitone ceramico 90°
- > senza bocca
- > per ceramica con erogazione da bordo
- > senza flessibili di alimentazione
- > con scarico

 **605007**  
p. 151

 **605008**  
p. 151

## CROMATO

01-6007

€

## ALTRE FINITURE

XX-6007

€

x M\*

6007/2

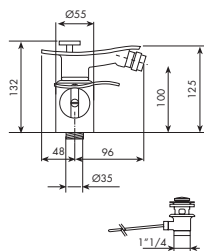

## GRUPPO BIDET MONOFORO

- > vitone ceramico 90°
- > interasse bocca 96
- > aeratore snodato
- > flessibili di alimentazione
- > con scarico

 **605007**  
p. 151

 **605008**  
p. 151

 **034008**  
p. 140

## CROMATO

01-6007/2

€

## ALTRE FINITURE

XX-6007/2

€

x M\*

6000/3/E + 604013

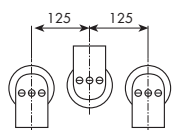

## GRUPPO INCASSO C/DEVIATORE 2 USCITE

- > vitone ceramico 90°
- > deviatore a dischi ceramici 2 uscite senza chiusura
- > maniglia a leva
- > attacchi da 1/2"

 **605007**  
p. 151

 **635010**  
p. 131

 **035346** fino 9.2017  
p. 131

## PARTI ESTERNE - CROMATO

01-6000/3/E

€

## PARTI ESTERNE - ALTRE FINITURE

XX-6000/3/E

€

x M\*

## PARTE INCASSO

604013

info pag. 35

€

## PREZZO TOTALE

€

W-8

## RICAMBI IMMEDIATI



**XX = CODICE FINITURA RICHIESTA:** per identificare codice corretto vedi pag. W-4  
**M\* = MOLTIPLICATORE:** per calcolare il prezzo delle altre finiture vedi tabella pag. W-4

6003/2/E + 914016

DEVIATORE INCASSO 2 USCITE

- > deviatore a dischi ceramici 2 uscite senza chiusura
- > attacchi da 1/2"

 **635010**

p. 131

 **035346** fino 9.2017

p. 131

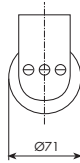

PARTI ESTERNE - CROMATO

01-6003/2/E €

PARTE INCASSO

914016 info pag. 38 €

PREZZO TOTALE €

PARTI ESTERNE - ALTRE FINITURE

XX-6003/2/E € **x M\***

I DOCCIA COMPLEMENTI CONSIGLIATI SONO PRESENTI SU LISTINO REVIVRE

6003/1

6009/1

GRUPPO DOCCIA ESTERNO

- > vitone ceramico 90°
- > senza set doccia
- > attacchi da 1/2"
- > maniglia a croce porcellana decorata

 **605007**

p. 151

 **605008**

p. 151

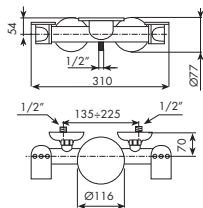

CROMATO

01-6009/1 €

ALTRE FINITURE

XX-6009/1 € **x M\***

6001/1

GRUPPO VASCA ESTERNO

- > vitone ceramico 90°
- > interasse bocca 180
- > uscita libera senza aeratore
- > deviatore a trazione/spinta senza ritorno automatico
- > flessibile in PVC 150 cm
- > supporto snodato
- > attacchi da 1/2"
- > doccetta monogetto in ABS con anticalcare

 **604007**

p. 151

 **604008**

p. 151

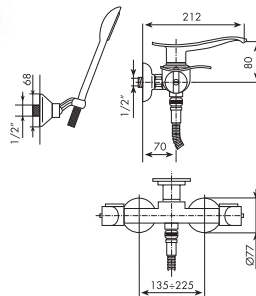

CROMATO

01-6001/1 €

ALTRE FINITURE

XX-6001/1 € **x M\***

6001/3

GRUPPO VASCA C/RACCORDI PER BORDO VASCA

- > vitone ceramico 90°
- > uscita libera senza aeratore
- > interasse bocca 212
- > deviatore a trazione/spinta senza ritorno automatico
- > flessibile in metallo 150 cm
- > supporto snodato
- > attacchi da 1/2"
- > doccetta monogetto in ABS c/anticalcare

 **604007**

p. 151

 **604008**

p. 151

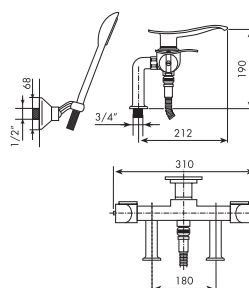

CROMATO

01-6001/3 €

ALTRE FINITURE

XX-6001/3 € **x M\***

RICAMBI IMMEDIATI



**XX = CODICE FINITURA RICHIESTA:** per identificare codice corretto vedi pag. W-4  
**M\* = MOLTIPLICATORE:** per calcolare il prezzo delle altre finiture vedi tabella pag. W-4



6001/2

BATTERIA PER BORDO VASCA

- > vitone ceramico 90°
- > interasse bocca 180
- > uscita libera senza aeratore
- > deviatore a dischi ceramici 2 uscite
- > flessibile in PVC 150 cm
- > senza flessibili di alimentazione
- > senza scarico
- > doccetta monogetto in ABS con anticalcare

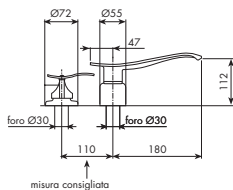
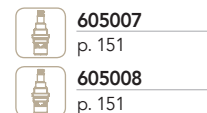

CROMATO		ALTRE FINITURE	
01-6001/2	€	XX-6001/2	€ x M*

6001/20

BATTERIA PER BORDO VASCA S/BOCCA

- > vitone ceramico 90°
- > senza bocca
- > deviatore a dischi ceramici 2 uscite
- > flessibile in PVC 150 cm
- > senza flessibili di alimentazione
- > senza scarico
- > doccetta monogetto in ABS con anticalcare

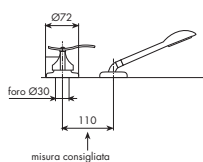

CROMATO		ALTRE FINITURE	
01-6001/20	€	XX-6001/20	€ x M*

6003

BOCCA VASCA DA PARETE

- > interasse bocca 245
- > erogazione libera senza aeratore
- > attacco da 1/2"

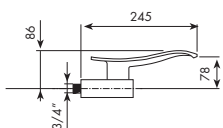

CROMATO		ALTRE FINITURE	
01-6003	€	XX-6003	€ x M*

6008/E + 604003 DX

RUBINETTO D'ARRESTO 1/2"

- > vitone ceramico 90°
- > ingressi da 1/2"

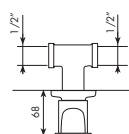
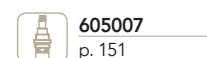

PARTI ESTERNE - CROMATO		PARTI ESTERNE - ALTRE FINITURE	
01-6008/E	€	XX-6008/E	€ x M*
PARTE INCASSO			
604003	info pag. 41 €		
PREZZO TOTALE		€	

6008/E + 604004 SX

RUBINETTO D'ARRESTO 1/2"

- > vitone ceramico 90°
- > ingressi da 1/2"

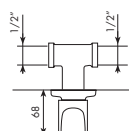
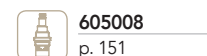

PARTI ESTERNE - CROMATO		PARTI ESTERNE - ALTRE FINITURE	
01-6008/E	€	XX-6008/E	€ x M*
PARTE INCASSO			
604004	info pag. 41 €		
PREZZO TOTALE		€	

## 6008/E + 604005 DX

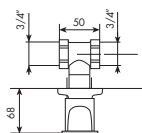

## RUBINETTO D'ARRESTO 3/4"

> vitone ceramico 90°  
> ingressi da 3/4"

 **605007**  
p. 151

## PARTI ESTERNE - CROMATO

01-6008/E €

## PARTE INCASSO

604005 info pag. 41 €

PREZZO TOTALE €

## PARTI ESTERNE - ALTRE FINITURE

**XX-6008/E** € **x M\***

## 6008/E + 604006 SX

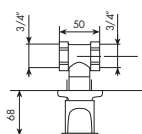

## RUBINETTO D'ARRESTO 3/4"

> vitone ceramico 90°  
> ingressi da 3/4"

 **605008**  
p. 151

## PARTI ESTERNE - CROMATO

01-6008/E €

## PARTE INCASSO

604006 info pag. 41 €

PREZZO TOTALE €

## PARTI ESTERNE - ALTRE FINITURE

**XX-6008/E** € **x M\***