



GRAZIE

DESIGN ALESSANDRO MENDINI



TABELLA PREZZI FINITURE pag. 222

INFO TECNICHE pag. 222

INDICE / INDEX pag. 224

LAVABO pag. 226

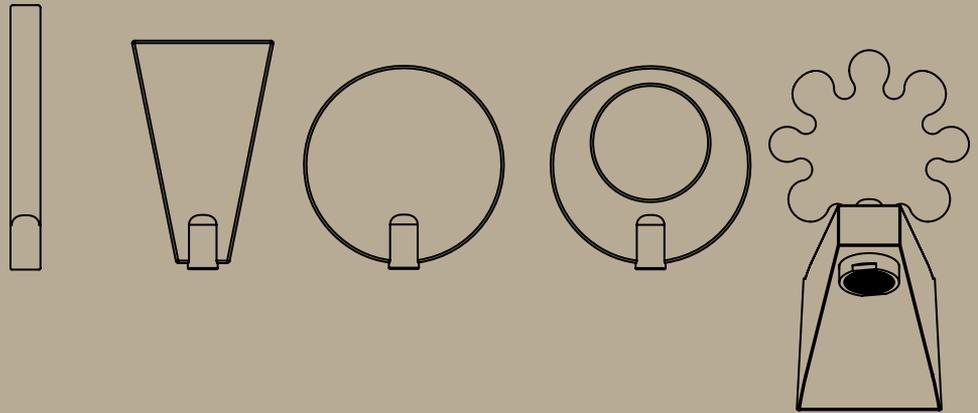
BIDET pag. 226

DOCCIA INCASSO pag. 226

DOCCIA ESTERNO pag. 227

VASCA pag. 227

BAGNO COMPLEMENTI pag. 227

PREZZO FINITURE

Calcola il prezzo di listino (IVA esclusa) delle finiture diverse dal cromato, consultando la seguente tabella.

Moltiplicare il PREZZO LISTINO per il COEFFICIENTE MOLTIPLICATORE della finitura scelta, arrotondando per difetto il prezzo ottenuto (eliminare i centesimi).
per ordinare art. 5505 in finitura dorato, leva NUVOLA stessa finitura: codice 04-5505-N-04

PRICE FINISHES

Include the list price (excluding VAT) of different finishes from chrome, consulting the following table. Multiply the PRICE LIST MULTIPLIER COEFFICIENT of the chosen finish, reducing the price obtained by deleting the centesim.

EXAMPLE to order art. 3005 gold finish, NUVOLA lever: code 04-5505-N-04

COMPOSIZIONE CODICE PER ORDINARE ARTICOLO IN FINITURA

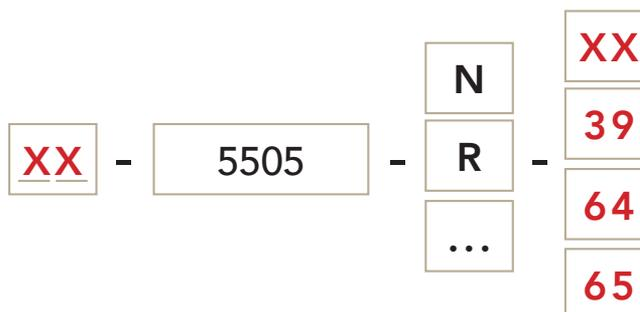

FINITURE DI SERIE / STANDARD FINISHES

CODICE CODE	DESCRIZIONE FINITURA FINISH DESCRIPTION	MOLTIPLICATORE MULTIPLIER
01-	cromato / chrome	PREZZO LISTINO*

FINITURE A RICHIESTA / ON REQUEST FINISHES

CODICE CODE	DESCRIZIONE FINITURA FINISH DESCRIPTION	MOLTIPLICATORE MULTIPLIER
02-	cromo/oro / chrome/gold	x
03-	oro/argento / gold/silver	x
04-	dorato / gold	x
05-	bronzo satinato / satin bronze	x
06-	rame vecchio / old copper	x
07-	vecchio argento / old silver	x
08-	canna di fucile / gun barrel	x
10-	verderame / verdigris	x
11-	nero antracite / anthracite black	x
12-	ottone lucido / polished brass	x
13-	ottone naturale / natural brass	x
14-	bianco / white	x
19-	nero / black	x
28-	nickel satinato / satin nickel	x
30-	nickel lucido / polished nickel	x

CODICE FINITURA FINISH CODE	CODICE ARTICOLO ITEM NUMBER	COD. LEVA LEVER CODE	COD. FINITURA LEVA FINISH CODE LEVER
-----------------------------	-----------------------------	----------------------	--------------------------------------

FINITURE A RICHIESTA / ON REQUEST FINISHES

CODICE CODE	DESCRIZIONE FINITURA FINISH DESCRIPTION	MOLTIPLICATORE MULTIPLIER
33-	cromo satinato / satin chrome	x
34-	cromo spazzolato / brushing chrome	x
35-	nickel spazzolato / brushing nickel	x
56-	avorio / ivory	x
57-	azzurro / light blue	x
58-	verdino / light green	x
59-	marrone / brown	x
60-	arancio / orange	x
61-	rosso / red	x
66-	bianco opaco / mat white	x
67-	nero opaco / mat black	x
68-	rame opaco / mat copper	x
69-	argento opaco / mat silver	x
71-	oro opaco / mat gold	x
72-	bronzo opaco / mat bronze	x
75-	dorato spazzolato / brushing gold	x
87-	oro rosa / pink gold	x
88-	ottone sisal / sisal brass	x

*PREZZO DI LISTINO / PRICE LIST

*NON REALIZZABILE / NOT MADE

ATTENZIONE! 13-OTTONE NATURALE e 88-OTTONE SISAL: finiture non protette che antichizzano naturalmente ossidando a contatto con l'umidità atmosferica. WARNING! 13-NATURAL BRASS and 88-SISAL BRASS: unprotected finishes that naturally oxidise in contact with atmospheric humidity.

PROGETTO SU MISURA: RICHIESTE SPECIALI

I tecnici di Bellosta Rubinetterie sono, inoltre, a disposizione di architetti e designers, per offrire un servizio esclusivo: personalizzazioni di elementi in funzione di specifiche richieste estetiche o problematiche legate a vincoli progettuali, verifica della fattibilità attraverso opportuni studi CAD e sviluppo del disegno tecnico del prodotto speciale richiesto.

Per informazioni e richieste PROGETTI SU MISURA: ufficiotecnico@bellostarubinetterie.com

PROGETTO SU MISURA: SPECIAL REQUESTS

Engineers Bellosta Rubinetterie are also available to architects and designers, to offer an exclusive service: customizations of items according to specific aesthetic requirements or issues related to design constraints, verification of the feasibility studies and development through appropriate CAD technical design the required special product. For information and requests "SU MISURA" PROJECTS: ufficiotecnico@bellostarubinetterie.com



CONSIGLIO TECNICO

Tutti i miscelatori della collezione GRAZIE vengono collaudati nel loro funzionamento al momento dell'assemblaggio. Per garantire la durata delle cartucce nel tempo, si consiglia di spurgare bene l'impianto idraulico prima del montaggio (per rimuovere eventuali detriti) e di installare rubinetti sottolavabo con filtro (art. 0920)

N.B.: Qualora il piano lavabo avesse uno spessore superiore a 6 cm specificare la misura al momento dell'ordine.

TECHNICAL ADVICE

All mixers of the GRAZIE collection are perfectly tested. To guarantee the perfect functionality of the cartridge for a long time, we advise to clean the sanitary plant before installing the mixer. Moreover we advise to install angle valve with filter (art. 0920).

Attention: If the lavatory top is more than cm 6 hick, please point it out when placing the order.



FORATURA DEI PIANI SANITARI

I miscelatori lavabo/bidet monoforo prevedono un foro di diametro 35 mm nel piano sanitario.

MONOFORO >>

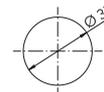

DRILLING PLANS HEALTH

The sink / hole bidet mixers provide a hole diameter of 35 mm in the health plan.

LE LEVE: le combinazioni disponibili

Nella collezione GRAZIE le leve in wengé, palissandro e zebrano sono disponibili su richiesta fino ad esaurimento.

N.B. In caso si voglia ordinare un articolo con inserto diverso da cromato, sostituire gli ultimi due numeri del codice (01) con il codice dell'inserto richiesto.

ESEMPIO: art. 01-5505-N-01 diventa 01-5505-N-39 per inserto wengé

LEVERS: combinations available

In the GRAZIE collection, wenge, rosewood and zebrano levers are available on request until exhaustion.

N.B. If you want to order an article with a chromed insert, replace the last two code numbers (01) with the required insertion code.

EXAMPLE: art. 01-5505-N-01 becomes 01-5505-N-39 for wenge insert

		MOZZO					
		NUVOLA (N) cromo	RAGGIO (R) cromo	VENTO (V) cromo	SOLE (S) cromo	LUNA (L) cromo	
INSERTO	cromo	01	01	01	01	01	
	wengé	39 A RICHIESTA	39 A RICHIESTA	39 A RICHIESTA	39 A RICHIESTA	39 A RICHIESTA	
	pallissandro	64 A RICHIESTA	64 A RICHIESTA	64 A RICHIESTA	64 A RICHIESTA	64 A RICHIESTA	
	zebrano	65 A RICHIESTA	65 A RICHIESTA	65 A RICHIESTA	65 A RICHIESTA	65 A RICHIESTA	

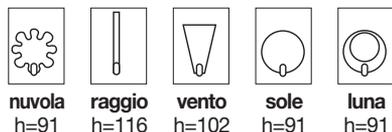

LEGENDA SIMBOLI

**ACCESSORI
ACCESSORIES**



**RICAMBI IMMEDIATI
IMMEDIATE PARTS**

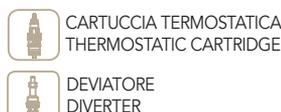

LAVABO



5505 pag. 226
 MISCELATORE LAVABO MONOFORO
 BASIN MIXER



5505/3/E + 894001 pag. 226
 MISCELATORE LAVABO DA PARETE
 WALL BASIN MIXER

parti esterne / external parts: 5505/3/E
 parte incasso / built-in part: 894001

BIDET



5507 pag. 226
 MISCELATORE BIDET MONOFORO
 BIDET MIXER

DOCCIA INCASSO



5521/E + 104018 pag. 226
 MISCELATORE INCASSO
 BUILT-IN MIXER

parti esterne / external parts: 5521/E
 parte incasso / built-in part: 104018



5500/E + 104002 pag. 226
 MISCELATORE INCASSO C/DEVIATORE 2 USCITE
 BUILT-IN MIXER WITH DIVERTER 2 OUT

parti esterne / external parts: 5500/E
 parte incasso / built-in part: 104002

DOCCIA ESTERNO



5509/1 pag. 227
 MISCELATORE DOCCIA ESTERNO
 EXTERNAL SHOWER MIXER

DOCCIA COMPLEMENTI



5503/1/A pag. 135*
 SUPPORTO DOCCIA COMPLETO
 FULL SHOWER SUPPORT



5503/1 pag. 135*
 SUPPORTO DOCCIA DUPLEX COMPLETO
 FULL SHOWER DUPLEX SUPPORT



5530 pag. 143*
 SALISCENDI COMPLETO C/PRESA D'ACQUA
 COMPLETE WALL PIPE WITH WATER CONNECTION



0530/1 pag. 145*
 ASTA SALISCENDI
 WALL PIPE

VASCA



5501/A pag. 227
 MISCELATORE VASCA ESTERNO
 EXTERNAL BATH MIXER



5503 pag. 227
 BOCCA VASCA DA PARETE
 WALL BATH SPOUT

BAGNO COMPLEMENTI



5508/E + 554012 o 554013 pag. 227
 RUBINETTO D'ARRESTO 1/2"
 BUILT-IN STOP COCK 1/2"

parti esterne / external parts: 5508/E
 parte incasso / built-in part: 554012 DX o 554013 SX



5508/E + 554014 o 554015 pag. 228
 RUBINETTO D'ARRESTO 3/4"
 BUILT-IN STOP COCK 3/4"

parti esterne / external parts: 5508/E
 parte incasso / built-in part: 554014 DX o 554015 SX

* ABBINAMENTO CONSIGLIATO: PER PREZZI E SCHEDE TECNICHE, VEDI RIFERIMENTO PAGINA LISTINO REVIVRE

* RECOMMENDED COMBINATION: FOR PRICES AND TECHNICAL DETAILS, LOOK AT PAGE WITH REFERENCE REVIVRE PRICE



BAGNO COMPLEMENTI

**5540/E + 884053**pag. **228**PASSO RAPIDO 3/4"
PASSO RAPIDO 3/4"parti esterne / external parts: 5540/E
parte incasso / built-in part: 884053**5540/E + 884054**pag. **228**PASSO RAPIDO 1"
PASSO RAPIDO 1"parti esterne / external parts: 5540/E
parte incasso / built-in part: 884054**5532/2/E + 035212**pag. **228**SARACINESCA
GATE VALVEparti esterne / external parts: 5532/2/E
parte incasso / built-in part: 035212

5505

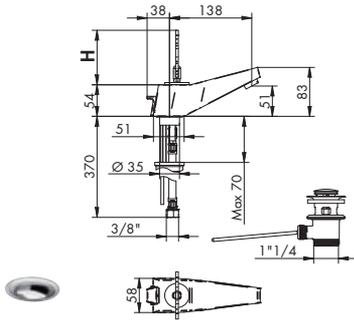

MISCELATORE LAVABO MONOFORO

- > cartuccia joystick
- > interasse bocca 138
- > flessibili di alimentazione
- > con scarico
- > H = per quota altezza vedi pag. 223



CROMATO

01-5505-N-01	leva nuvola	€
01-5505-R-01	leva raggio	€
01-5505-V-01	leva vento	€
01-5505-S-01	leva sole	€
01-5505-L-01	leva luna	€

ALTRE FINITURE

XX-5505-N-XX	leva nuvola	€	x M*
XX-5505-R-XX	leva raggio	€	x M*
XX-5505-V-XX	leva vento	€	x M*
XX-5505-S-XX	leva sole	€	x M*
XX-5505-L-XX	leva luna	€	x M*

5505/3/E + 894001

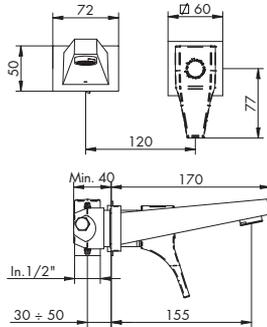
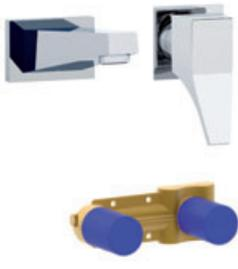

MISCELATORE LAVABO DA PARETE

- > cartuccia tradizionale
- > interasse bocca 155
- > ingressi da 1/2"
- > senza scarico
- > rosoni separati



PARTI ESTERNE - CROMATO

01-5505/3/E	€
-------------	---

PARTI ESTERNE - ALTRE FINITURE

XX-5505/3/E	€	x M*
-------------	---	------

PARTE INCASSO

01-894001	info pag. 34	€
-----------	--------------	---

PREZZO TOTALE	€
---------------	---

5507

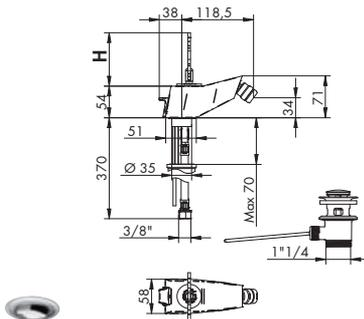

MISCELATORE BIDET MONOFORO

- > cartuccia joystick
- > interasse bocca 118.5
- > aeratore snodato
- > flessibili di alimentazione
- > con scarico
- > H = per quota altezza vedi pag. 223



CROMATO

01-5507-N-01	leva nuvola	€
01-5507-R-01	leva raggio	€
01-5507-V-01	leva vento	€
01-5507-S-01	leva sole	€
01-5507-L-01	leva luna	€

ALTRE FINITURE

XX-5507-N-XX	leva nuvola	€	x M*
XX-5507-R-XX	leva raggio	€	x M*
XX-5507-V-XX	leva vento	€	x M*
XX-5507-S-XX	leva sole	€	x M*
XX-5507-L-XX	leva luna	€	x M*

5521/E + 104018

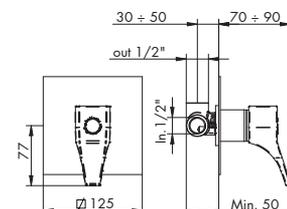

MISCELATORE INCASSO

- > cartuccia tradizionale
- > attacchi da 1/2"
- > uscita superiore
- > incasso con B-Box



PARTI ESTERNE - CROMATO

01-5521/E	€
-----------	---

PARTI ESTERNE - ALTRE FINITURE

XX-5521/E	€	x M*
-----------	---	------

PARTE INCASSO

01-104018	info pag. 36	€
-----------	--------------	---

PREZZO TOTALE	€
---------------	---

5500/E + 104002

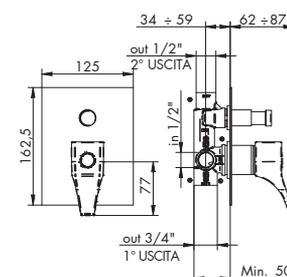

MISCELATORE INCASSO C/DEVIATORE 2 USCITE

- > cartuccia tradizionale
- > deviatore a pressione 2 uscite c/ritorno automatico e blocco meccanico basse pressioni
- > attacchi da 1/2"
- > uscita principale inferiore da 3/4"
- > incasso con B-Box



PARTI ESTERNE - CROMATO

01-5500/E	€
-----------	---

PARTI ESTERNE - ALTRE FINITURE

XX-5500/E	€	x M*
-----------	---	------

PARTE INCASSO

01-104002	info pag. 37	€
-----------	--------------	---

PREZZO TOTALE	€
---------------	---



5509/1

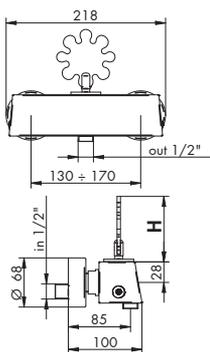

MISCELATORE DOCCIA ESTERNO

- > cartuccia joystick
- > senza set doccia
- > attacchi da 1/2"
- > H = per quota altezza vedi pag. 223

 555001
p. 150

CROMATO

01-5509/1-N-01	leva nuvola	€
01-5509/1-R-01	leva raggio	€
01-5509/1-V-01	leva vento	€
01-5509/1-S-01	leva sole	€
01-5509/1-L-01	leva luna	€

ALTRE FINITURE

XX-5509/1-N-XX	leva nuvola	€	x M*
XX-5509/1-R-XX	leva raggio	€	x M*
XX-5509/1-V-XX	leva vento	€	x M*
XX-5509/1-S-XX	leva sole	€	x M*
XX-5509/1-L-XX	leva luna	€	x M*

I DOCCIA COMPLEMENTI CONSIGLIATI SONO PRESENTI SU LISTINO REVIVRE

5503/1/A

5503/1

5530

0530/1

5501/A

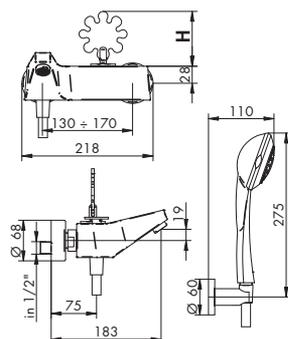

MISCELATORE VASCA ESTERNO

- > cartuccia joystick
- > Interasse bocca 183
- > deviatore a trazione con ritorno automatico e blocco meccanico per basse pressioni
- > flessibile in PVC 150 cm
- > supporto a parete fisso
- > doccetta anticalcare multigetto
- > H = per quota altezza vedi pag. 223
- > attacchi da 1/2"

 555001
p. 150

 045057
p. 131

 034005
p. 140

CROMATO

01-5501/A-N-01	leva nuvola	€
01-5501/A-R-01	leva raggio	€
01-5501/A-V-01	leva vento	€
01-5501/A-S-01	leva sole	€
01-5501/A-L-01	leva luna	€

ALTRE FINITURE

XX-5501/A-N-XX	leva nuvola	€	x M*
XX-5501/A-R-XX	leva raggio	€	x M*
XX-5501/A-V-XX	leva vento	€	x M*
XX-5501/A-S-XX	leva sole	€	x M*
XX-5501/A-L-XX	leva luna	€	x M*

5503

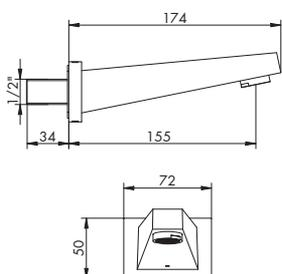

BOCCA VASCA DA PARETE

- > interasse bocca 155
- > attacco da 1/2"

 034005
p. 140

CROMATO

01-5503	€
---------	---

ALTRE FINITURE

XX-5503	€	x M*
---------	---	------

5508/E + 554012 DX o 554013 SX

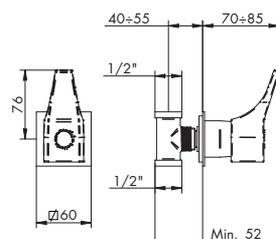

RUBINETTO D'ARRESTO 1/2"

- > vitone ceramico 90°
- > ingressi da 1/2"

 035046
p. 150

 085003
p. 151

PARTI ESTERNE - CROMATO

01-5508/E	€
-----------	---

PARTE INCASSO

554012 o 554013	info pag. 40	€
-----------------	--------------	---

PREZZO TOTALE	€
---------------	---

PARTI ESTERNE - ALTRE FINITURE

XX-5508/E	€	x M*
-----------	---	------

RICAMBI IMMEDIATI



XX = CODICE FINITURA RICHIESTA: per identificare codice corretto vedi pag. 222
M* = MULTIPLICATORE: per calcolare il prezzo delle altre finiture vedi tabella pag. 222

5508/E + 554014 (DX) o 554015 (SX)

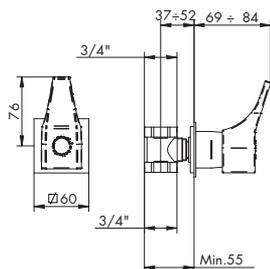
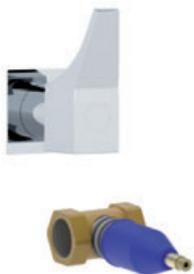

RUBINETTO D'ARRESTO 3/4"

> vitone ceramico 90°
> ingressi da 3/4"

	035046 p. 150
	085003 p. 151

PARTI ESTERNE - CROMATO	
01-5508/E	€
PARTE INCASSO	
554014 o 554015	info pag. 41 €
PREZZO TOTALE	€

PARTI ESTERNE - ALTRE FINITURE	
XX-5508/E	€ x M*

5540/E + 884053

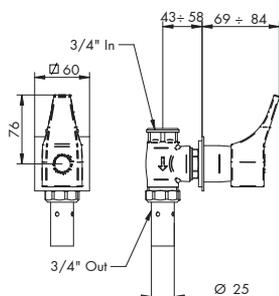

PASSO RAPIDO 3/4"

> vitone tradizionale
> abbinare a saracinesca
> ingressi da 3/4"

	884021 p. 151
--	------------------

PARTI ESTERNE - CROMATO	
01-5540/E	€
PARTE INCASSO	
884053	info pag. 42 €
PREZZO TOTALE	€

PARTI ESTERNE - ALTRE FINITURE	
XX-5540/E	€ x M*

5540/E + 884054

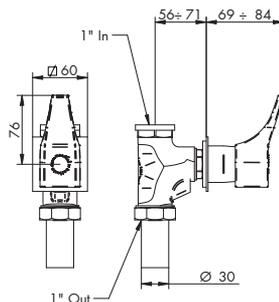

PASSO RAPIDO 1"

> vitone tradizionale
> abbinare a saracinesca
> ingressi da 1"

	884021 p. 151
--	------------------

PARTI ESTERNE - CROMATO	
01-5540/E	€
PARTE INCASSO	
884054	info pag. 42 €
PREZZO TOTALE	€

PARTI ESTERNE - ALTRE FINITURE	
XX-5540/E	€ x M*

5532/2/E + 035212

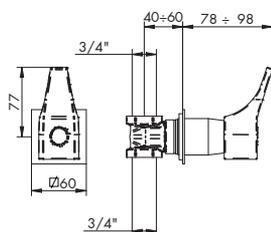

SARACINESCA

> attacchi da 3/4"

PARTI ESTERNE - CROMATO	
01-5532/2/E	€
PARTE INCASSO	
035212	info pag. 42 €
PREZZO TOTALE	€

PARTI ESTERNE - ALTRE FINITURE	
XX-5532/2/E	€ x M*



