



---

*la tecnologia del calore the technology of heat  
la technologie de la chaleur la tecnología del calor*

---

# FOCOLARI A R I A

---

*Air-heating fireboxes Foyers Air Hogares Aire*

---



**PALAZZETTI**  
IL CALORE CHE PIACE ALLA NATURA

## Legenda dei simboli

Key of symbols. Légende des symboles.  
Leyenda de los símbolos.



Alimentazione a legna  
Wood burning  
Fonctionnement au bois  
Funcionamiento con leña



Alimentazione a Pellet  
Pellet burning  
Fonctionnement aux pellets  
Funcionamiento con pellets



Alimentazione a Pellet/Legna  
Wood/Pellet burning  
Fonctionnement aux bois/pellets  
Funcionamiento con leña/pellets



Riscaldamento ad aria canalizzabile e potenza ventilatore  
Heating by ducted air and fan power  
Chauffage avec sortie d'air canalisable et puissance ventilateur  
Calefacción por aire canalizable y potencia del ventilador



Riscaldamento ad aria per irraggiamento  
Heating by air through radiation  
Chauffage à air par rayonnement  
Calefacción por aire por radiación



Potenza termica massima  
Maximum thermal power  
Puissance calorifique maximale  
Máxima potencia térmica



Ampia visione della fiamma  
An extensive view of the fire  
Large vision du feu  
Amplia visión de la llama



Inseribile in camini preesistenti  
Can be fitted in existing fireplaces  
Installable dans une cheminée existante  
Incorporable a chimeneas existentes



Prodotto completamente automatico e programmabile  
Fully automatic and programmable product  
Produit entièrement automatique et programmable  
Producto completamente automático y programable



Prodotto gestibile da smartphone tramite APP  
This product can be controlled from your smartphone by means of an APP  
Produit contrôlable depuis smartphone via une APP  
Producto controlable mediante smartphone con la APP



Adatto alla cottura  
Suitable for cooking  
Adapté à la cuisson  
Apto para la cocción

---

# INDICE

---

INDEX. SOMMAIRE. ÍNDICE.

- 04 - Un impegno con l'ambiente  
A commitment with the environment.  
Un engagement avec la nature.  
Un compromiso con el medio ambiente.
- 06 - O<sub>2</sub>Ring
- 08 - Riscaldamento ad aria canalizzabile  
Ductable heating by air  
Chauffage à sortie d'air canalisable  
Calefacción por aire canalizable
- 10 - Ecomonoblocco
- 20 - Ecopalex
- 24 - Inerti
- 28 - Iki
- 30 - Multifire - Multifire BIO
- 36 - Ecofire® da Inserimento & da Rivestimento  
Ecofire® for Building in or Cladding  
Ecofire® à intégrer et pour habillage  
Ecofire® empotrables y para revestimientos
- 40 - Dati tecnici - Technical data  
Données techniques - Especificaciones técnicas
- 67 - Accessori - Accessories  
Accessoires - Accesorios
- 68 - Certificazioni - Certifications  
Certifications - Certificaciones



# PALAZZETTI: I MOTIVI CHE FANNO LA DIFFERENZA

THE FACTS THAT MAKE THE DIFFERENCE. LES RAISONS QUI FONT LA DIFFÉRENCE.  
LAS RAZONES QUE MARCAN LA DIFERENCIA.



## *Ricerca*

Investiamo notevoli risorse umane ed economiche nella ricerca e sviluppo, per creare nuove tecnologie, perfezionare quelle esistenti, ottimizzare i rendimenti e diminuire l'emissione di gas nocivi.

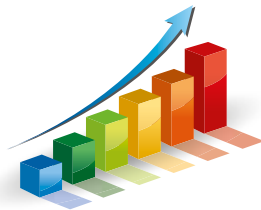

## *Prestazioni costanti nel tempo*

La tecnologia e l'esperienza Palazzetti non temono la prova degli anni: i nostri prodotti sono progettati e costruiti per durare e dare sempre il massimo. Questo è il vero risparmio.



## *Made in Italy*

Da sempre abbiamo deciso di privilegiare la progettazione, la qualità e il design italiani, mantenendo tutto il lavoro nelle nostre sedi nazionali.

### **Reserch.**

We invest remarkable human and financial resources in research and development to create new technologies and to perfect existing ones, to optimise fuel efficiency and further decrease emissions of harmful gasses.

### **Recherche.**

Nous investissons de remarquables ressources humaines et économiques dans la recherche et le développement pour créer de nouvelles technologies, pour perfectionner celles qui existent déjà, pour optimiser les rendements et pour réduire les émissions de gaz nocifs.

### **Investigación.**

Invertimos muchos recursos humanos y económicos en la investigación y el desarrollo, para crear nuevas tecnologías, perfeccionar las existentes, optimizar los rendimientos y reducir la emisión de gases perjudiciales.

### **Durable performances.**

Palazzetti's technology and experience do not fear the test of time: all our products have been designed and constructed to last and to offer utmost performances, always.

This is what really makes you save.

### **Performances constantes dans le temps.**

La technologie et l'expérience Palazzetti ne craignent pas le temps qui passe : nos produits ont été conçus et fabriqués pour durer longtemps, pour toujours offrir le meilleur rendement et pour permettre de faire de vraies économies.

### **Prestaciones constantes en el tiempo.**

La tecnología y experiencia de Palazzetti no temen la prueba del tiempo: nuestros productos están proyectados y construidos para durar y ofrecer siempre lo mejor. Este es el auténtico ahorro.



### **Made in Italy.**

Palazzetti has always privileged Italian project engineering, quality and design and has always chosen to keep its production in Italy.

### **Made in Italy.**

Dès le départ, nous avons décidé de privilégier la conception, la qualité et le design italiens, en effectuant tout le travail dans nos usines sises en Italie.

### **Made in Italy.**

Desde siempre hemos decidido privilegiar el proyecto, la calidad y el diseño italianos, manteniendo aquí todo el trabajo, en nuestras plantas nacionales.



### *Ambiente*

Creare sistemi che riscaldino con il massimo confort e rispettino l'ecosistema: è la nostra mission. Questo si concretizza in prodotti dalle alte prestazioni capaci di garantire nel tempo una combustione particolarmente performante con elevati rendimenti e basse emissioni in atmosfera.



### *Garanzia Palazzetti*

Da oltre 60 anni diamo certezze, non a parole, ma con i fatti. Tutta la nostra produzione viene sottoposta ad un doppio severissimo collaudo. Questo ci rende assolutamente sicuri della qualità dei nostri prodotti nel tempo.



### *Certificazioni*

Tutti i nostri prodotti sono testati e certificati secondo le più severe normative internazionali. L'esposizione del marchio e del numero di certificazione garantisce che il prodotto acquistato sia stato controllato e omologato in conformità agli standard qualitativi più rigorosi.

#### **Environmental protection.**

We create heating systems that offer extreme comfort and respect the environment: this is our mission. Consequently, we create products with high performances capable of guaranteeing remarkably superior combustion while offering high efficiencies and low emissions.

#### **Environnement.**

Créer des systèmes qui chauffent en offrant un confort maximal et qui respectent l'écosystème: telle est notre mission. Cela se concrétise par des produits à hautes performances capables d'assurer, dans le temps, une combustion particulièrement performante, c'est-à-dire avec de hauts rendements et de basses émissions polluantes dans l'atmosphère.

#### **Medio ambiente.**

Producir sistemas que calienten con el máximo confort, respetuosos con el ecosistema: es nuestro reto. Esto se concreta en productos con altas prestaciones capaces de garantizar en el tiempo una combustión especialmente rendidora, o sea con elevados rendimientos y bajas emisiones a la atmósfera.



#### **Palazzetti's guarantee.**

For almost 60 years we have been delivering certainties, not with words but with facts. Our entire production undergoes very strict double tests. This makes us fully confident that the top quality of our products will withstand the test of time.

#### **Garantie Palazzetti.**

Depuis plus de 60 ans, nous offrons des certitudes, non pas avec des mots, mais avec des faits concrets. Toute notre production est soumise à une double série d'essais très rigoureux. Voilà pourquoi nous sommes absolument certains de la qualité de nos produits pendant très longtemps.

#### **Garantía Palazzetti.**

Desde hace más de 60 años vamos proporcionando certidumbre, no sólo con las palabras, sino con los hechos. Toda nuestra producción es sometida a un doble ensayo muy riguroso. Esto asegura la calidad de nuestros productos en el tiempo.

#### **Certifications.**

All our products are tested and certified according to the strictest international regulations. By displaying the label and the certificate number we guarantee that the product purchased has been checked and approved in compliance with the most rigorous quality standards.

#### **Certifications.**

Tous nos produits ont été testés et certifiés selon les normes internationales les plus sévères. Le label et le numéro de certification apposés sur le produit que vous avez acheté, assure qu'il a été contrôlé et homologué conformément aux standards de qualité les plus stricts.

#### **Certificaciones.**

Todos nuestros productos son probados y certificados conforme a las más rígidas normativas internacionales. La exposición de la marca y del número de certificado garantiza que el producto adquirido ha sido controlado y homologado conforme a los más rigurosos estándares de calidad.

---

# UN IMPEGNO CON L'AMBIENTE

---

A COMMITMENT WITH THE ENVIRONMENT. UN ENGAGEMENT AVEC LA NATURE.  
UN COMPROMISO CON EL MEDIO AMBIENTE.

## *La legna energia rinnovabile e disponibile*

---

La legna (e il pellet di legna) è una fonte energetica già disponibile che da sola rappresenta in Europa il 51% dell'energia da fonti rinnovabili. La combustione della legna contribuisce a raggiungere gli obiettivi posti dal protocollo di Kyoto per la riduzione dei gas effetto serra nell'atmosfera.

### **Wood is renewable and plentiful energy.**

Wood and wood pellets are readily-available sources of energy that in Europe account for 51% of the energy from renewable sources all by themselves. Wood combustion contributes to achieving the goals set by the Kyoto protocol for the reduction of the greenhouse effect.

### **Le bois, énergie renouvelable et disponible.**

Le bois (ou les pellets de bois) est une source d'énergie déjà disponible qui, à elle seule, représente 51% des énergies renouvelables en Europe. La combustion du bois contribue à atteindre les objectifs posés par le Protocole de Kyoto pour la réduction des gaz à effet de serre dans l'atmosphère.

### **La leña, energía renovable y disponible.**

La leña (y el pellet de leña) es una fuente energética ya disponible, que por sí sola constituye en Europa un 51% de la energía producida por fuentes renovables. La combustión de la leña contribuye a alcanzar los objetivos establecidos por el protocolo de Kyoto para la reducción de los gases con efecto invernadero a la atmósfera.

## *Il ciclo della natura*

---

La corretta combustione della legna si inserisce perfettamente nel ciclo della natura perché sprigiona la stessa quantità di anidride carbonica che la pianta ha assorbito durante il suo ciclo vitale. Si restituisce così in atmosfera nulla più di quanto sia stato già assorbito: ecco realizzarsi una condizione di perfetto equilibrio.

### **Nature's cycle.**

Proper wood combustion fits into nature's cycle perfectly because it produces the same quantity of carbon dioxide that the plant absorbs during its life cycle. The atmosphere receives nothing more than the same quantity of carbon dioxide that has already been absorbed: this is how a perfect balance with nature is achieved.

### **Le cycle de la nature.**

La combustion correcte du bois s'intègre parfaitement dans le cycle de la nature. En effet, elle dégage la même quantité d'anhydride carbonique que celle absorbée par la plante durant son cycle de vie. On restitue donc à l'atmosphère rien de plus que ce qui a déjà été absorbé : on atteint ainsi l'équilibre parfait.

### **El ciclo de la naturaleza.**

La correcta combustión de la leña se adapta perfectamente al ciclo de la naturaleza porque libera la misma cantidad de anhídrido carbónico que la planta ha absorbido durante su ciclo de vida. Así que se devuelve a la atmósfera lo que ya se ha absorbido: de esta forma se realiza una condición de perfecto equilibrio.

## *Doppia combustione Palazzetti*

---

Per garantire sempre una combustione in equilibrio con il ciclo della natura i nostri laboratori di ricerca hanno elaborato il sistema della Doppia Combustione che, unitamente a vari accorgimenti tecnici, garantisce maggiori rendimenti e minori emissioni inquinanti.

### **Palazzetti's dual combustion.**

To guarantee combustion that is always in a perfect balance with nature's cycle, our research laboratories have developed the Dual Combustion system that, combined with various technical devices, ensures better efficiencies and lower polluting emissions.

### **Double combustion Palazzetti.**

Pour que la combustion soit toujours en équilibre avec le cycle de la nature, nos laboratoires de recherche ont élaboré le système de la Double Combustion qui, en association avec d'autres caractéristiques techniques du foyer, garantit de meilleurs rendements et de plus faibles émissions polluantes.

### **Doble combustión Palazzetti.**

Para garantizar siempre una combustión en equilibrio con el ciclo de la naturaleza nuestros laboratorios de investigación han creado el sistema de la Doble Combustión que, junto con otras soluciones técnicas, garantiza más rendimiento y menos emisiones contaminantes.

## Schema "ciclo della natura"

Nature's cycle diagram. Schéma du cycle de la nature. Croquis del ciclo de la naturaleza

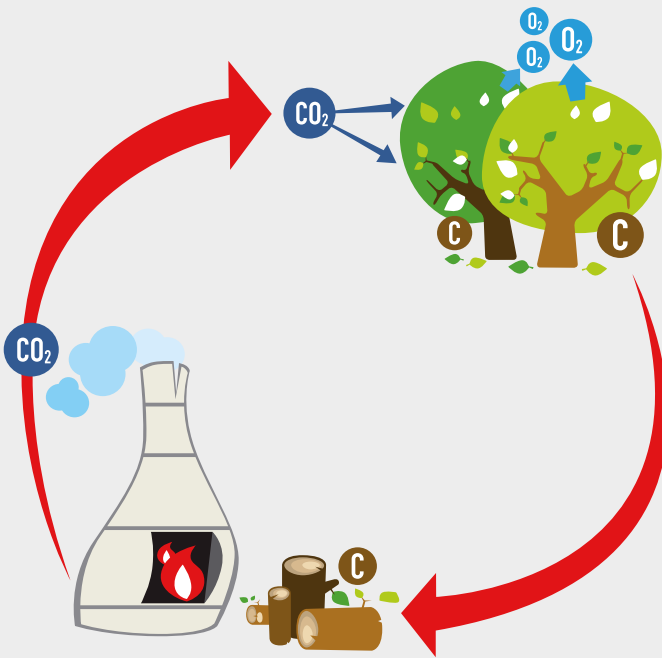

Bruciando la legna correttamente (Doppia Combustione Palazzetti unitamente a vari altri accorgimenti tecnologici) il carbonio si combina con l'ossigeno e produce una quantità di anidride carbonica in equilibrio con la natura. Le piante assorbono l'anidride carbonica dall'aria, recuperano il carbonio per la loro crescita e sprigionano ossigeno.

When wood burns correctly (like in Palazzetti's Dual Combustion system combined with other technical devices) carbon combines with oxygen and produces a quantity of carbon dioxide that is in harmony with nature. Le piante assorbono l'anidride carbonica dall'aria, recuperano il carbonio per la loro crescita e sprigionano ossigeno.

Si l'on brûle les bûches de bois correctement (Double Combustion Palazzetti en association avec d'autres caractéristiques technologiques), le carbone se combine à l'oxygène et produit une quantité d'anhydride carbonique en équilibre avec la nature. Les plantes absorbent l'anhydride carbonique dans l'air, récupèrent le carbone pour leur croissance et dégagent de l'oxygène.

Quemando correctamente la leña (Doble Combustión Palazzetti junto con otras soluciones técnicas) el carbono se combina con el oxígeno y produce una cantidad de anhídrido carbónico en equilibrio con la naturaleza. Las plantas absorben el anhídrido carbónico del aire, recuperan el carbono para su crecimiento y liberan oxígeno.

## Schema funzionamento doppia combustione

Dual combustion diagram. Schéma du fonctionnement de la double combustion. Croquis de funcionamiento de la doble combustión.

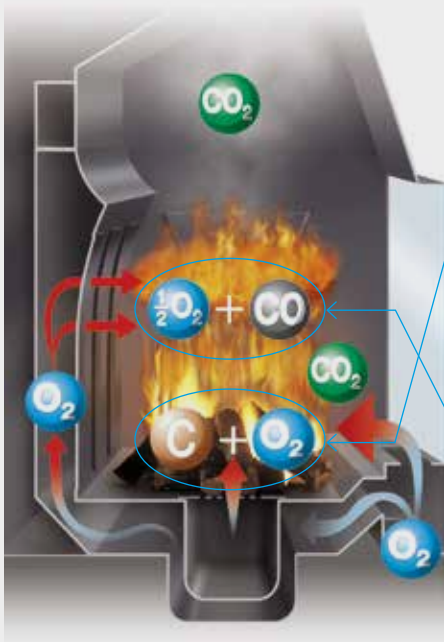

Con la doppia combustione Palazzetti si hanno due combustioni:

Palazzetti's dual combustion produces two types of combustion:

Avec la double combustion Palazzetti, on obtient deux combustions :

Con la doble combustión Palazzetti se obtienen dos combustiones:

**La prima:** la legna tramite l'ossigeno brucia, sprigionando anidride carbonica CO<sub>2</sub> e una certa quantità di CO, secondo la reazione:

**The first:** the wood burns by means of oxygen and produces carbon dioxide (CO<sub>2</sub>) as well as a certain quantity of CO as a result of the following reaction:

**La première:** le bois brûle grâce à l'oxygène tout en dégageant de l'anhydride carbonique CO<sub>2</sub> et une certaine quantité de CO, selon la réaction suivante :

**Con la primera:** la leña arde aprovechando el oxígeno y liberando anhídrido carbónico CO<sub>2</sub> y cierta cantidad de CO, conforme a la reacción:

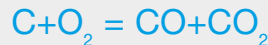

**La seconda:** dell'ossigeno preriscaldato (O<sub>2</sub>) viene immesso nel focolare per bruciare l'incombusto CO secondo la reazione:

**The second:** some pre-heated oxygen (O<sub>2</sub>) is added to the firebox to burn the unburned CO as a result of the following reaction:

**La seconde:** de l'oxygène préchauffé (O<sub>2</sub>) est introduit dans le foyer pour brûler le CO imbrûlé selon la réaction suivante :

**Con la segunda:** el oxígeno previamente calentado (O<sub>2</sub>) se inyecta en el hogar para quemar el CO incombusto conforme a la reacción:



**Risultato finale:** più calore, maggiore resa e una quantità di anidride carbonica in equilibrio con il ciclo della natura.

**The end result:** more heat, better performances and a quantity of carbon dioxide that harmonises with nature's cycle.

**Résultat final :** plus de chaleur, un meilleur rendement et une quantité d'anhydride carbonique en équilibre avec le cycle de la nature.

**Resultado final:** más calor, más rendimiento y una cantidad de anhídrido carbónico en equilibrio con el ciclo de la naturaleza.

---

# SISTEMA BREVETTATO PER L'ABBATTIMENTO DELLE POLVERI SOTTILI

---

A PATENTED SYSTEM THAT REDUCES PARTICULATES.  
SYSTÈME BREVETÉ POUR LA RÉDUCTION DES PARTICULES FINES.  
SISTEMA CON PATENTE PARA LA REDUCCIÓN DE LAS PARTÍCULAS FINAS.



## Funzionamento

Anche la migliore combustione produce del particolato composto per il 52% da IPA\* genericamente chiamati polveri sottili. I nostri laboratori in collaborazione con le Università di Torino e Trieste e partner internazionali hanno progettato il sistema di abbattimento polveri sottili O<sub>2</sub>Ring. Un dispositivo composto da elementi attivi che a contatto con i fumi della combustione, innescano una reazione chimica controllata che neutralizza le polveri\* e il monossido di carbonio.

### How it works.

Even the best combustion produces particulates that are composed of 52% PAH\* generally called particulates. Our laboratories, together with the Universities of Turin and Trieste, plus the collaboration of international partners, have designed the O<sub>2</sub>Ring to reduce particulates. This device is composed of active elements that, when they come into contact with combustion fumes, start a controlled chemical reaction that neutralises the particulates\* and the carbon dioxide.

### Fonctionnement.

Même la meilleure combustion produit des particules en suspension se composant à 52% d'HAP\* génériquement appelées particules fines. Nos laboratoires ont collaboré avec les Universités de Turin et de Trieste et avec nos partenaires internationaux pour concevoir notre système O<sub>2</sub>Ring permettant de réduire la quantité de particules fines: il s'agit d'un dispositif se composant d'éléments actifs qui, au contact avec les fumées de la combustion, amorcent une réaction chimique contrôlée neutralisant les particules\* et le monoxyde de carbone.

### Funcionamiento.

Hasta la mejor combustión produce material particulado formado en un 52% por HAPs\* generalmente denominados partículas finas. Nuestros laboratorios, en colaboración con las Universidades de Turín y Trieste y otros colaboradores internacionales, han proyectado el sistema de reducción de las partículas finas O<sub>2</sub>Ring. Un dispositivo formado por elementos activos que, en contacto con los humos de la combustión, dan lugar a una reacción química controlada que neutraliza los polvos y el monóxido de carbono.

## Vantaggi

Riduce dell'80% gli agenti inquinanti presenti nei fumi della combustione; funziona senza corrente elettrica; risponde alle esigenze di quelle zone geografiche in cui le disposizioni di legge limitano l'uso dei prodotti a biomassa; semplice da pulire; riciclabile; duraturo nel tempo perchè realizzato con materiali nati per impianti industriali.

### Advantages:

It reduces up to 80% of the polluting contents of combustions fumes; it works without electricity; it meets the requirements of the geographical areas in which the law limits the use of products fuelled by biomasses; it is easy to clean; recyclable; it is long-lasting because made from industrial grade materials.

### Avantages :

Il réduit de 80% les agents polluants présents dans les fumées de la combustion; il fonctionne sans courant électrique ; il répond aux besoins de certaines zones géographiques où les dispositions de loi limitent l'usage des appareils de chauffage à biomasse ; il est simple à nettoyer, recyclable et dure longtemps parce qu'il est réalisé avec des matériaux nés pour les installations industrielles.

### Ventajas:

Ventajas: reduce hasta un 80% los agentes contaminantes en los humos de la combustión; funciona sin necesidad de fluido eléctrico; cumple las exigencias de las zonas geográficas donde las disposiciones legales limitan el uso de los productos que funcionan con biomasa; fácil limpieza; reciclable; duradero en el tiempo porque está realizado con materiales creados para las instalaciones industriales.

\* Idrocarburi Policiclici Aromatici

Polycyclic Aromatic Hydrocarbons Hydrocarbures  
Aromatiques Polycycliques Hydrocarburos  
Aromáticos Policíclicos



**Polveri sottili e monossido di carbonio**

~ 80% in meno (certificato di prova K560201161 istituto tedesco TÜV RHEINLAND)

Particulates and carbon monoxide ~ 80% less (K560201161 test certificate issued by the German TÜV RHEINLAND Institute)

Particules fines et monoxyde de carbone : ~ 80% en moins (certificat d'essai K560201161 institut allemand TÜV RHEINLAND)

Un 80% menos de partículas finas y monóxido de carbono (certificado de ensayo K560201161 Instituto alemán TÜV RHEINLAND)

**O<sub>2</sub>Ring**

sistema di depurazione collegato con by-pass automatico alla valvola VDF del caminetto.

O<sub>2</sub>Ring a purifying system connected to the VDF valve of the firebox by means of an automatic by-pass.

O<sub>2</sub>Ring : système d'épuration relié au clapet VDF de la cheminée moyennant un by-pass automatique.

O<sub>2</sub>Ring sistema de depuración conectado con by-pass automático a la válvula VDF de la chimenea.

**Fumi di combustione**

48% sali minerali non nocivi 52% IPA \*idrocarburi policiclici aromatici

Combustion fumes 48% harmless mineral salts 52% PAH \*Polycyclic Aromatic Hydrocarbons

Fumées de combustion : 48% sels minéraux non nocifs 52% HAP \*Hydrocarbures Aromatiques Polycycliques

Humos de la combustión 48% sales minerales no perjudiciales 52% HAPS \*Hidrocarburos Aromáticos Policíclicos

**Fumi depurati**

Purified fumes

Fumées épurées

Humos depurados

**Celle O<sub>2</sub>Ring caricate positivamente**

Positively charged O<sub>2</sub>Ring cells

Cellules O<sub>2</sub>Ring chargées positivement

Células O<sub>2</sub>Ring cargadas positivamente

**Reazione di ossidazione ad alta temperatura**

High-temperature oxidizing reaction

Reaction d'oxydation à haute température

Reacción de oxidación a alta temperatura

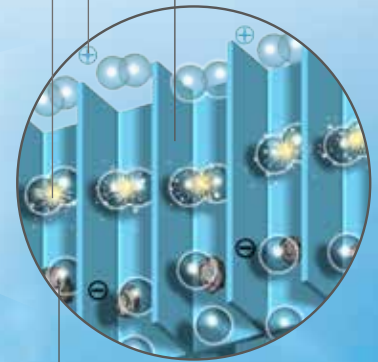

**IPA caricate negativamente**

Negatively charged PAH

HAP chargés négativement

HAPS cargados negativamente

*Dati dell'istituto TÜV Rheinland*

Data provided by the TÜV Rheinland Institute - Données de l'Institut TÜV Rheinland - Datos del Instituto TÜV Rheinland

**POLVERI - PARTICULATES - PARTICULES - PARTÍCULAS mg/Nm<sup>3</sup>**

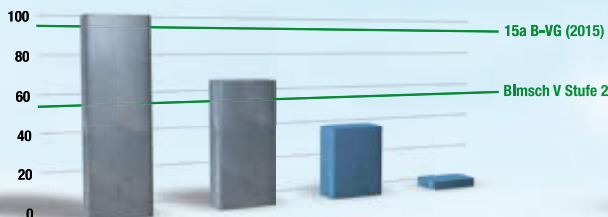

CAMINETTO TRADIZIONALE TRADITIONAL FIREBOX CHEMINÉE TRADITIONNELLE CHIMENEA TRADICIONAL	CAMINETTO PRESTAZIONALE HIGH PERFORMING FIREBOX CHEMINÉE PERFORMANTE CHIMENEA DE ALTAS PRESTACIONES	CAMINETTO TRADIZIONALE + O <sub>2</sub> RING TRADITIONAL FIREBOX + O <sub>2</sub> RING CHEMINÉE TRADITIONNELLE + O <sub>2</sub> RING CHIMENEA TRADICIONAL + O <sub>2</sub> RING	CAMINETTO PRESTAZIONALE + O <sub>2</sub> RING HIGH PERFORMING FIREBOX + O <sub>2</sub> RING CHEMINÉE PERFORMANTE + O <sub>2</sub> RING CHIMENEA DE ALTAS PRESTACIONES + O <sub>2</sub> RING
--	--	--	--

**EMISSIONI DI CO - EMISSIONS CO - ÉMISSIONS CO - EMISIONES CO mg/Nm<sup>3</sup>**

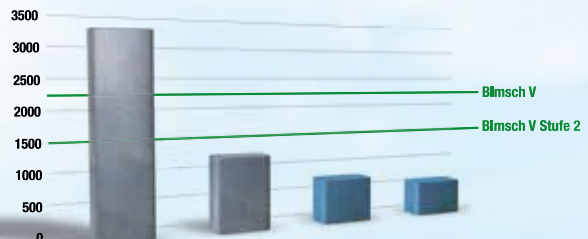

CAMINETTO TRADIZIONALE TRADITIONAL FIREBOX CHEMINÉE TRADITIONNELLE CHIMENEA TRADICIONAL	CAMINETTO PRESTAZIONALE HIGH PERFORMING FIREBOX CHEMINÉE PERFORMANTE CHIMENEA DE ALTAS PRESTACIONES	CAMINETTO TRADIZIONALE + O <sub>2</sub> RING TRADITIONAL FIREBOX + O <sub>2</sub> RING CHEMINÉE TRADITIONNELLE + O <sub>2</sub> RING CHIMENEA TRADICIONAL + O <sub>2</sub> RING	CAMINETTO PRESTAZIONALE + O <sub>2</sub> RING HIGH PERFORMING FIREBOX + O <sub>2</sub> RING CHEMINÉE PERFORMANTE + O <sub>2</sub> RING CHIMENEA DE ALTAS PRESTACIONES + O <sub>2</sub> RING
--	--	--	--

# RISCALDAMENTO AD ARIA: GUIDA ALLA SCELTA

*Focolari con funzionamento a legna, a pellet, ad alimentazione mista legna/pellet, sono veri impianti di riscaldamento ad aria. Ecologici, robusti, resistenti nel tempo, con alti rendimenti certificati, possono scaldare intere abitazioni. Ideali come fonte di riscaldamento unica o per integrare sistemi tradizionali a gas/metano per ridurre consumi e costi di gestione.*

## HEATING BY AIR: GUIDE TO YOUR CHOICE

*Wood or pellet-burning, and mixed wood-pellet burning, fireboxes are real air heating systems. Ecological, sturdy and long-lasting, with certified high efficiencies they can heat entire homes. They are ideal for use as the only source of heat or to integrate traditional gas/natural gas systems to reduce consumptions and heating costs.*

## CALEFACCIÓN POR AIRE: GUÍA A LA ELECCIÓN

*Hogares con funcionamiento de leña, pellets, con alimentación mixta leña/pellets, son unas auténticas instalaciones de calefacción por aire. Ecológicos, robustos, resistentes en el tiempo, con altos rendimientos certificados, pueden calentar enteras viviendas. Ideales como fuente de calefacción única o para integrar sistemas tradicionales con gas/metano para reducir los consumos y costes de funcionamiento.*

## CHAUFFAGE À SORTIE D'AIR: GUIDE DE CHOIX

*Foyers fonctionnant au bois, aux pellets ou mixte bois/pellets. Ce sont de véritables installations de chauffage à circulation d'air. Écologiques, robustes, résistants et avec de hauts rendements certifiés, ils peuvent chauffer des habitations entières. Idéaux comme source de chauffage unique ou pour intégrer des systèmes traditionnels au gaz/gaz naturel, afin de réduire les consommations et les coûts du chauffage.*



Everspring Palazzetti



Impianto di climatizzazione professionale per caldo/freddo, nella modalità inverno, scalda ad aria sfruttando un generatore ad acqua.  
Per info [www.palazzetti.it](http://www.palazzetti.it)

Professional hot and cold air conditioning system. In the winter mode it heats by blowing hot air created by a water generator. For info please visit [www.palazzetti.it](http://www.palazzetti.it)

Installation de climatisation professionnelle pour production chaud/froid. En mode hiver, elle chauffe par circulation d'air en exploitant un générateur à eau. Pour info [www.palazzetti.it](http://www.palazzetti.it)

Instalación de climatización profesional para tener calor/frío, en la modalidad invierno calienta por aire aprovechando un generador por agua. Para más información [www.palazzetti.it](http://www.palazzetti.it)

## Scegli il combustibile:

Choose the fuel: Choisissez le type de combustible : Elige el combustible:



**LEGNA\***  
**WOOD\***  
**BOIS\***  
**LEÑA\***

Scegli la legna per il fascino della fiamma a vista, se hai spazi per lo stoccaggio del combustibile, per scaldare e cucinare insieme.

Choose firewood to heat and cook if you love the fascination of fire and you have room to store the fuel.

Choisissez le bois si vous souhaitez un feu apparent, à condition d'avoir de la place pour stocker le combustible, pour chauffer et en même temps cuisiner.

Opta por la leña por el encanto de la llama a la vista, si tienes espacio suficiente donde almacenar el combustible, para calentar y cocinar al mismo tiempo.



**PELLET**  
**PELLETS**  
**PELLETS**  
**PELLET**

Scegli il pellet perché è pratico, facile da reperire, stoccare, caricare. Utilizzabile in focolari completamente automatici.

Choose pellets because they are practical, easy to find, store and transport. Can be used in fully-automatic fireboxes.

Choisissez les pellets parce qu'ils sont pratiques et faciles à trouver, à stocker et à charger. Utilisable dans des foyers entièrement automatiques.

Opta por el pellet porque es práctico, fácil de encontrar, almacenar, cargar. Utilizable en hogares completamente automáticos.



**MISTO**  
**MIX**  
**MIXTE**  
**MIXTO**

Scegli di non rinunciare a nulla, nè al fascino della fiamma a legna nè all'automaticità della tecnologia a pellet: li puoi utilizzare entrambi nella gamma Multifire Palazzetti.

Choose to miss out on nothing at all: neither the fascination of a wood fire nor the automatic operation of pellet technology: you can use them both in the Multifire Palazzetti range.

Choisissez de ne renoncer à rien, ni au charme du feu de bois ni à la technologie automatique des pellets : vous pourrez utiliser les deux modes de fonctionnement en optant pour la gamme des Multifire Palazzetti.

Opta por tenerlo todo, sin renunciar al encanto de la llama obtenida con la leña ni a la tecnología automática del pellet: con la gama Multifire Palazzetti puedes utilizar las dos cosas.

*Ecomonoblocco*  
pag. 10

*Ecopalex*  
pag. 20

*Inserto*  
pag. 24

*Ecofire® da inserimento*  
pag. 36

*Ecofire® da rivestimento*  
pag. 36

*Multifire*  
pag. 30

\*La nostra offerta si completa con la gamma focolari aperti: richiedi il catalogo!  
\*Our range is completed by our line of open-fronted fireboxes: ask for your catalogue!  
\*Pour compléter notre offre, nous disposons d'une gamme de foyers ouverts : demandez notre catalogue !  
\*Nuestra oferta se completa con la gama de hogares abiertos: pide el catálogo!

# ECOMONOBLOCCO

*Un focolare sicuro, resistente ed ecologico, che sviluppa una notevole potenza termica e può riscaldare, da solo, un'intera abitazione. L'ampia gamma di Ecomonoblocchi si divide in tre macrofamiglie: Easy Line, Ecomonoblocchi con focolare in ghisa e focolare in Magnofix.*

## ECOMONOBLOCCO

*A safe, resistant and ecological firebox that develops a remarkable thermal power and can heat an entire home all by itself. The vast range of Ecomonoblocchi fireboxes is divided into three large families: Easy Line, Ecomonoblocchi models with cast iron fireboxes and with Magnofix fireboxes.*

## ECOMONOBLOCCO

*Un foyer sûr, résistant et écologique, qui développe une considérable puissance calorifique et qui peut chauffer, à lui seul, une habitation entière. La vaste gamme des Ecomonoblocchi se divise en trois macro-familles : Easy Line, Ecomonoblocchi avec foyer en fonte et ceux avec foyer en Magnofix.*

## ECOMONOBLOCCO

*Un hogar seguro, resistente y ecológico, que desarrolla una considerable potencia térmica y él sólo llega a calentar una entera vivienda. La extensa gama de Ecomonoblocchos se subdivide en tres grandes familias: Easy Line, Ecomonoblocchos con hogar de hierro fundido y hogar de Magnofix.*



ECOMONOBLOCCO 78 3D



ECOMONOBLOCCO 45 TONDO



ECOMONOBLOCCO 64 EXAGONE



ECOMONOBLOCCO 66 180°



BRIGHTON



ECOMONBLOCCO 86 DX/SX



ECOMONBLOCCO EM 16:9 3D



ECOMONBLOCCO 16:9 FRONTALE



ECOMONBLOCCO 25:9 BIFACCIALE

## MONOBLOCCHI EASY LINE

---

La gamma Monoblocchi Easy Line ha focolare interamente in ghisa di alto spessore, portina scorrevole a scomparsa con sistema automatico di pulizia vetro e possibilità di canalizzare l'aria in più ambienti. Nei modelli Easy Line la valvola VDF viene regolata dall'installatore ma mantiene l'automatismo di apertura e chiusura con lo scorrimento della portina. Bocchette di serie.

The range of Monoblocco Easy Line models has very thick cast iron fireboxes, concealed sliding doors with an automatic glass cleaning system and the possibility of ducting hot air to heat various rooms. In the Easy Line models the VDF valve is adjusted by the installer but it operates automatically when the door is opened and shut. Standard vents.

La gamme des Monoblocchi Easy Line a un foyer entièrement réalisé en fonte très épaisse, une porte relevable escamotable doté d'un système de nettoyage automatique de la vitre et offre la possibilité de canaliser l'air dans plusieurs pièces. Sur les modèles Easy Line, le clapet VDF® est réglé par l'installateur, mais il maintient l'automatisme d'ouverture et de fermeture avec le coulissement de la porte. Bouches de soufflage standard.

La gama de Monobloccos Easy Line tiene el hogar íntegramente de hierro fundido de grosor elevado, la puerta corredera oculta con sistema automático de limpieza del vidrio y la posibilidad de canalizar el aire hacia varios cuartos. En los modelos Easy Line la válvula VDF es regulada por el instalador, sin embargo mantiene el automatismo de apertura y cierre al correr la puerta. Boquillas de serie.

## ECOMONOBLOCCHI GHISA

---

La gamma Ecomonoblocchi ghisa è caratterizzata da un focolare realizzato con oltre 75 kg di piastre in ghisa dall'eccezionale spessore di 8 mm. Sono dotati della Doppia Combustione, valvola VDF brevettata e sistema automatico di pulizia vetro. I modelli frontali presentano una portina con cornice ridotta al minimo per la massima visione della fiamma. I modelli angolari ed esagone hanno portina con vetro unico. Portaceppi e bocchette di serie.

The cast iron Ecomonoblocco range boasts a firebox constructed using more than 75 kg of exceptionally thick 8 mm cast iron plates. They are provided with Dual Combustion, the patented VDF valve and the automatic glass cleaning system. The frontal models have doors with very slim frames, leaving more room to admire the fire. The door of the corner and Exagone models is made of a single pane of glass. Standard firewood holders and vents.

La gamme des Ecomonoblocchi Ghisa est caractérisée par un foyer réalisé avec plus de 75 kg de plaques en fonte avec une épaisseur exceptionnelle de 8 mm. Ils sont dotés de la Double Combustion, du clapet VDF® breveté et du système de nettoyage automatique de la vitre. Les modèles frontaux ont une porte avec un cadre très fin pour permettre une vision maximale du feu. Les modèles d'angle et exagone ont une porte avec une seule vitre. Support pour bûches et bouches de soufflage en standard.

La gama de Ecomonobloccos de hierro fundido se caracteriza por el hogar realizado con más de 75 kg de planchas de hierro fundido cuyo grosor excepcional es de 8 mm. Están provistos de Doble Combustión, válvula VDF con patente y sistema automático de limpieza del vidrio. Los modelos frontales tienen la puerta con el marco reducido al mínimo para la máxima visión de la llama. Los modelos de esquina y exagone tiene la puerta con un único vidrio. Portaleña y boquillas de serie.

## ECOMONOBLOCCHI MAGNOFIX

---

La gamma Ecomonoblocchi Magnofix è caratterizzata da un focolare realizzato in Magnofix, un refrattario speciale che ottimizza l'irraggiamento e migliora la combustione garantendo elevati rendimenti. Sono dotati della Doppia Combustione, valvola VDF brevettata e sistema automatico di pulizia vetro. I modelli frontali presentano una portina con cornice ridotta al minimo per la massima visione della fiamma. I modelli angolari ed esagone hanno portina con vetro unico. Portaceppi e bocchette di serie.

The Ecomonoblocco Magnofix range is distinguished by a firebox made from Magnofix, a special, very high heat accumulation, refractory material that optimises radiation and improves combustion thus guaranteeing superior efficiency. These fireboxes are provided with Dual Combustion, the patented VDF valve and the automatic glass cleaning system. The frontal models have doors with very slim frames, leaving more room to admire the fire. The door of the corner and Exagone models is made of a single pane of glass. Standard firewood holders and vents.

La gamme des Ecomonoblocchi Magnofix se distingue par un foyer réalisé en Magnofix, un matériau réfractaire particulier avec un très haut pouvoir d'accumulation qui permet d'optimiser le rayonnement et d'améliorer la combustion tout en assurant de hauts rendements. Ils sont dotés de la Double Combustion, du clapet VDF® breveté et du système de nettoyage automatique de la vitre. Les modèles frontaux ont une porte avec un cadre très fin pour permettre une vision maximale du feu. Les modèles d'angle et exagone ont une porte avec une seule vitre. Support pour bûches et bouches de soufflage en standard.

La gama de Ecomonobloccos Magnofix se caracteriza por el hogar realizado en Magnofix, un especial refractario de altísima acumulación que optimiza la radiación y mejora la combustión garantizando rendimientos elevados. Están provistos de Doble Combustión, válvula VDF con patente y sistema automático de limpieza del vidrio. Los modelos frontales tienen la puerta con el marco reducido al mínimo para la máxima visión de la llama. Los modelos de esquina y exagone tiene la puerta con un único vidrio. Portaleña y boquillas de serie.



EASY LINE	FRONTALE	DX/SX	EXAGONE	TONDO	3D	BIFACCIALE
	frontal frontal frontal	rh/lh d/g der/izq		round arrondi redondo		double-fronted double façade bifacial
64	X	X	X			
78	X	X	X			
86	X	X				



GHISA	FRONTALE	DX/SX	EXAGONE	TONDO	TONDO 3D 180°	BIFACCIALE
cast iron fonte Hierro fundido	frontal frontal frontal	rh/lh d/g der/izq		round arrondi redondo	round arrondi redondo	double-fronted double façade bifacial
45	X			X		X
64	X	X	X			
66	X		X	X	X	X
78	X	X	X			
86	X	X				
16:9	X					



MAGNOFIX	FRONTALE	DX/SX	EXAGONE	TONDO	3D	BIFACCIALE
	frontal frontal frontal	rh/lh d/g der/izq		round arrondi redondo		double-fronted double façade bifacial
66	X		X	X	X	
78	X	X	X		X	X
86	X	X				
16:9					X	X
25:9	X					X

# APPROFONDIMENTO TECNICO

## TECHNICAL SPECIFICATIONS. APPROFONDISSEMENT TECHNIQUE. PROFUNDIZACIÓN TÉCNICA.

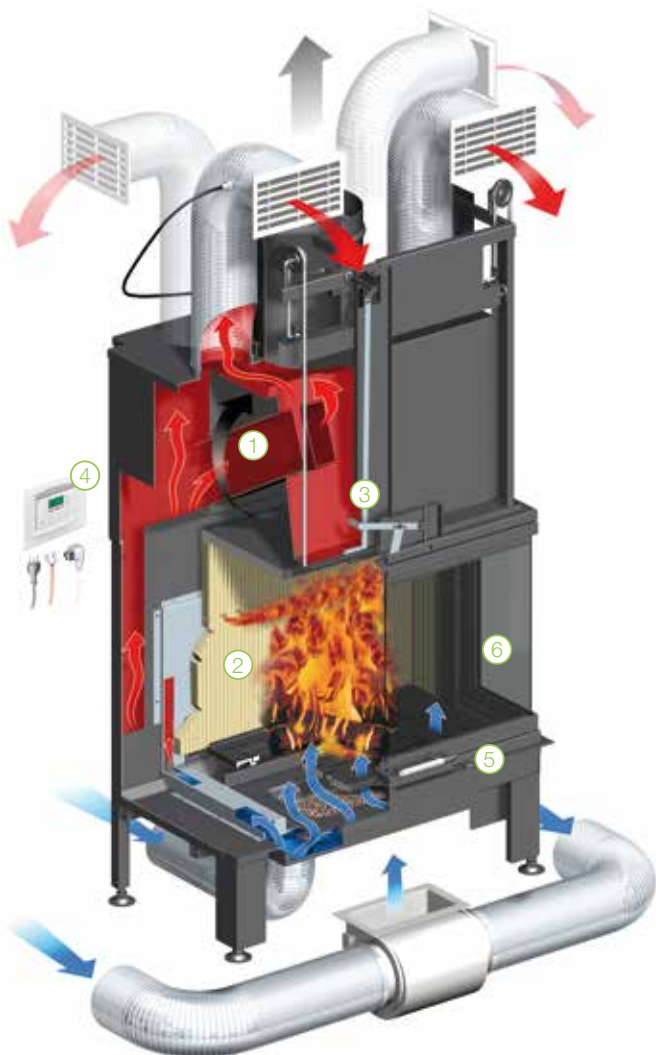

ECOMBL 78 DX MAGNOFIX



### Caldaia ermetica in acciaio 1

con scambiatore di calore composto da:

- ampia intercapedine verticale con alettature, per favorire la distribuzione omogenea dell'aria da riscaldare;
- fascio tubiero per recuperare al meglio il calore della combustione, aumentando sensibilmente la resa termica.

**Sealed steel heat exchange chamber** with heat-exchanger composed of:

- a large, vertical, finned gap that favours the even distribution of the air to be heated;
- the tube nest that recovers the greatest possible amount of heat created by combustion to noticeably increase thermal outputs.

**Corps de chauffe étanche en acier** avec échangeur de chaleur se constituant de :

- large enveloppe verticale munie d'ailettes pour faciliter la distribution homogène de l'air à chauffer ;
- faisceau tubulaire pour récupérer au mieux la chaleur de la combustion, en augmentant sensiblement la performance thermique.

**Caldera estanca de acero** con intercambiador de calor formado por:

- amplio hueco vertical con aletas, para favorecer la distribución homogénea del aire que calentará;
- haz de tubos para recuperar al máximo el calor de la combustión, lo que aumenta considerablemente el rendimiento térmico.



### Focolare in ghisa, Magnofix e Thermofix 2

in base al modello il focolare può essere tutto in ghisa (da 8 mm), in Magnofix o in Thermofix. Tali materiali, grazie agli elevati spessori e alla conformazione, garantiscono resistenza, durata nel tempo ed elevati rendimenti.

**Cast iron, Magnofix or Thermofix firebox**

depending on the firebox model it can be constructed entirely in 8 mm thick cast iron, Magnofix or in Thermofix with a cast iron base. Thanks to their very thick walls and to their shape, both materials guarantee resistance, long-life and high performances.

**Foyer en fonte, Magnofix ou en Thermofix**

en fonction du modèle, le foyer peut être réalisé soit entièrement en fonte de 8 mm soit, Magnofix en Thermofix avec embase en fonte. Grâce à leur forte épaisseur et à leur forme particulière, les deux matériaux offrent au foyer résistance, longévité et hauts rendements.

**Hogar de hierro fundido, Magnofix o Thermofix**

En función del modelo el hogar puede ser todo de hierro fundido de 8 mm, Magnofix o de Thermofix con base de hierro fundido. Ambos materiales, gracias a su grosor elevado y a su forma, garantizan resistencia, durabilidad a lo largo del tiempo y rendimientos elevados.



**Mod. 16:9 3D:** apertura della portina a scatto automatica.

**Mod. 16:9 3D:** automatic push-to-open door.

**Mod. 16:9 3D:** ouverture automatique de la porte par déclit.

**Mod. 16:9 3D:** apertura automática por presión de la puerta.





### *Valvola VDF® brevettata\** **3**

consente l'adeguamento del tiraggio alle diverse condizioni atmosferiche o di installazione, garantendo un tiraggio perfetto anche all'apertura della portina (la valvola si apre automaticamente per evitare fastidiosi sbuffi di fumo, per poi tornare nella posizione preselezionata a portina chiusa).

#### **Patented\* VDF® valve**

it adapts the flue draught to the various weather or installation conditions, ensuring a perfect draught even when the door is opened (the valve opens automatically to prevent the smoke from escaping and then goes back to its set position when the door is shut).

#### **Clapet VDF® breveté\***

il permet d'adapter le tirage aux diverses conditions atmosphériques ou d'installation et d'assurer un tirage parfait même à l'ouverture de la porte (le clapet s'ouvre automatiquement pour éviter les fastidieuses sorties de fumée puis revient dans la position sélectionnée au préalable lorsque l'on referme la porte).

#### **Válvula VDF® con patente\***

consiente la adaptación del tiro a las distintas condiciones atmosféricas o de instalación, garantizando el tiro perfecto también al abrir la puerta (la válvula se abre automáticamente para evitar las molestas salidas de humo y luego vuelve a la posición previamente seleccionada con la puerta cerrada).



### *Kit ventilatore con centralina* **4**

Elettroventilatore centrifugo (80W) con centralina elettronica da incasso con regolazione della ventilazione automatica o manuale. Il display digitale visualizza la temperatura dell'aria; in modalità automatica modula la velocità del ventilatore in base alla temperatura del caminetto consentendo di canalizzare fino a 850 m³/h di aria calda.

#### **Fan kit with built-in digital control unit**

Centrifugal electric fan (80W) with a built-in electronic control unit with automatic or manual fan adjustment. The digital display shows the air temperature: in the automatic mode it adjusts fan speed according to the temperature of the firebox making it possible to convey 850 m³/h of hot air.

#### **Kit ventilateur avec contrôle électronique à encastrer**

Électro-ventilateur centrifuge (80W) et centrale de contrôle électronique à encastrer avec réglage de la ventilation automatique ou manuelle. L'afficheur digital visualise la température de l'air. En mode automatique, il permet de moduler la vitesse du ventilateur en fonction de la température de la cheminée et de canaliser jusqu'à 850 m³/h d'air chaud.

#### **Kit ventilador con centralita empotrable**

Electroventilador centrifugo (80W) con centralita electrónica empotrable y regulación de la ventilación automática o manual. El display digital visualiza la temperatura del aire; en la modalidad automática ajusta la velocidad del ventilador en función de la temperatura de la chimenea, impulsando hasta 850 m³/h de aire caliente.



### *Registro aria comburente* **5**

consente di gestire la combustione e controllare i consumi, assicurando un'alta resa e un sicuro risparmio.

#### **Combustion air register**

it manages combustion thus controlling consumptions and ensuring a high output and guaranteed savings.

#### **Registre de l'air comburant**

il permet de gérer la combustion et de contrôler les consommations, en obtenant une haute performance et en réalisant des économies.

#### **Registro de aire comburente**

permite controlar la combustión y los consumos, asegurando alto rendimiento y ahorro seguro.



### *Design minimale\** **6**

i modelli frontali hanno subito un restyling della portina, la cornice è stata portata a filo vetro, per aumentare la visione della fiamma (il monoblocco viene fornito di maniglia fredda esterna e di maniglia classica, da montare a discrezione dell'utente).

#### **Minimal design\***

the front models have a restyled door: in fact, the frame is now flush with the glass to increase the view of the fire (the Monoblocco firebox is supplied with an external cool-touch handle and a traditional handle, leaving the choice to the user).

#### **Design minimaliste\***

les modèles frontaux ont subi un restylage de la porte, le cadre se trouve à fleur de la vitre pour mieux admirer le feu (le Monoblocco est fourni avec une poignée froide extérieure et une poignée classique que l'utilisateur pourra monter s'il le souhaite).

#### **Diseño minimal\***

los modelos frontales han sido sometidos a restyling de la puerta, dejando el marco a ras del vidrio, para potenciar la vista de la llama (el monoblocco está equipado con manija fría exterior y manija clásica, que el usuario puede instalar según su propio criterio).



# ESEMPI DI INSTALLAZIONE

INSTALLATION EXAMPLES. EXEMPLES D'INSTALLATION. EJEMPLOS DE INSTALACIÓN



**SYDNEY** ECOMONOBLOCCO 45 TONDO



**WAVE** ECOMONOBLOCCO 66 FRONTALE





**ACAPULCO** ECOMONOBLOCCO 66 180°



**DALLAS** ECOMONOBLOCCO 66 BIFACCIALE



# ESEMPI DI INSTALLAZIONE

INSTALLATION EXAMPLES. EXEMPLES D'INSTALLATION. EJEMPLOS DE INSTALACIÓN



BRESSANONE ECOMONOBLOCCO 78 EXA



GOA ECOMONOBLOCCO 78 APERTO DX/SX





**DELHI** ECOMONOBLOCCO 16:9 BIFACCIALE



**KENSINGTON** ECOMONOBLOCCO 25:9



# ECOPALEX®

*Un focolare capace di trasformare un vecchio caminetto, fumoso e poco funzionale, in un vero impianto di riscaldamento ad aria, efficiente, sicuro, ecologico, senza richiedere interventi di opere murarie. Ecopalex®, abbinato al nostro ventilatore professionale e mediante un adeguato sistema di canalizzazione, riesce a soddisfare il fabbisogno calorico di intere abitazioni.*



ECOPALEX® N70



ECOPALEX® 88

## ECOPALEX®

*This firebox is able to transform an old, smoky and impractical fireplace into a real, efficient, safe and ecological air-heating system with no need for specific masonry work. Combined with our professional fan and by means of a suitable ducting system, Ecopalex® is able to meet the heating requirements of entire homes.*

## ECOPALEX®

*Un foyer capable de transformer une vieille cheminée qui fume et qui fonctionne mal, en une véritable installation de chauffage à circulation d'air, efficace, sûre, écologique et sans besoin d'œuvres de maçonnerie. Associé à notre ventilateur professionnel et moyennant un système de canalisation adéquat, l'Ecopalex® parvient à répondre au besoin calorifique d'une habitation entière.*

## ECOPALEX®

*Un hogar capaz de convertir una vieja chimenea, que echa humo y no resulta funcional, en una auténtica instalación de calefacción por aire, eficiente, segura, ecológica, sin precisar obras. Ecopalex®, en combinación con nuestro ventilador profesional y mediante el oportuno sistema de canalización, llega a cumplir el requerimiento calorífico de enteras viviendas.*



ECOPALEX® N64 DX/SX



ECOPALEX® N66



ECOPALEX® N76 TONDO



ECOPALEX® 78



EPOQUE - ECOPALEX® GLASS 76 RASTREMATO



ECOPALEX® GLASS 66



ECOPALEX® GLASS 70 RASTREMATO



ECOPALEX® GLASS 88

GAMMA range gamme gama	FRONTALE	DX/SX	RASTREMATO TONDO	
	frontal frontal frontal	rh/lh d/g der/izq	tapered trapèze chaflán	round arrondi redondo
N64	X	X		X
N66	X			
N70			X	
N76	X	X	X	X
78	X			
88	X			
GLASS 66	X			
GLASS 70			X	
GLASS 76			X	
GLASS 88	X			



# APPROFONDIMENTO TECNICO

## TECHNICAL SPECIFICATIONS. APPROFONDISSEMENT TECHNIQUE. PROFUNDIZACIÓN TÉCNICA.

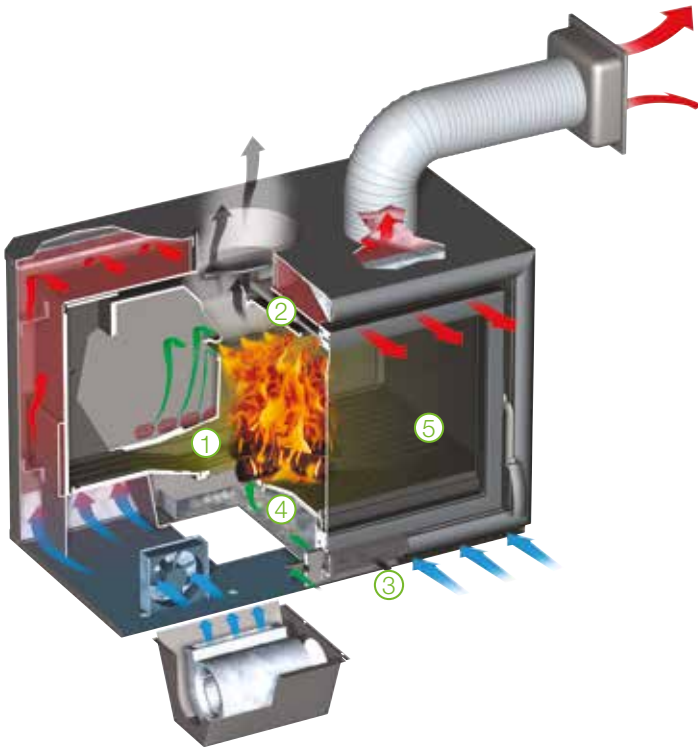

ECOPALEX® 88.



### Focolare in ghisa

1

dall'eccezionale spessore di 9 mm garantisce resistenza, durata nel tempo ed elevati rendimenti.

#### Cast iron firebox

thanks to its exceptional 9 mm thickness it guarantees resistance, long-life and high performances.

#### Foyer en fonte

d'une épaisseur exceptionnelle de 9 mm, il offre résistance, longévité et hauts rendements.

#### Hogar de hierro fundido

con un grosor excepcional de 9 mm garantiza resistencia, durabilidad en el tiempo y elevados rendimientos.



### Doppia combustione

2

Il focolare dell'Ecopalex è stato disegnato e progettato per favorire la doppia combustione: l'ossigeno segue un percorso particolare per preriscaldarsi e viene immesso ad un'altezza utile all'incontro con il monossido di carbonio frutto della combustione primaria.

#### Dual combustion

The Ecopalex firebox has been designed and engineered to favour dual combustion: the oxygen follows a special route that pre-heats it and then enters the firebox at the right height to meet the carbon monoxide produced by primary combustion.

#### Double combustion

Le foyer de l'Ecopalex a été dessiné et conçu pour favoriser la double combustion: l'oxygène suit un parcours particulier pour se préchauffer puis il est introduit à une hauteur qui lui permet de rencontrer le monoxyde de carbone issu de la combustion primaire.

#### Doble combustión

El hogar del Ecopalex está diseñado para favorecer la doble combustión: el oxígeno realiza un recorrido particular para calentarse previamente y se inyecta a una altura útil para combinarse con el gas carbónico que resulta de la combustión primaria.



Il camino fuma e scalda poco.

The fireplace is smoky and inefficient.

La cheminée fume et chauffe mal.

La chimenea echa humo y calienta poco.

Inserimento dell'Ecopalex® senza opere murarie.

Add the Ecopalex® firebox without calling the builders.

Installation de l'Ecopalex® sans besoin d'œuvres de maçonnerie.

Incorporación del Ecopalex® sin obras.

Con Ecopalex® il camino non fuma e rende molto di più.

Thanks to Ecopalex® the fireplace is no longer smoky and is much more efficient.

Avec l'Ecopalex®, la cheminée ne fume plus et chauffe beaucoup plus.

Con Ecopalex® la chimenea no echa humo y es mucho más rendidora.

In base alla versione, è possibile avere gli Ecopalex® con la possibilità di ventilare l'aria dalle griglie frontali oppure attraverso un ventilatore centrifugo canalizzarla in più ambienti.

Depending on the version, our Ecopalex® fireboxes can diffuse hot air through its front grids or through ducts by means of a centrifugal fan to various rooms.

En fonction de la version, nos Ecopalex® peuvent diffuser l'air à travers les bouches situées à l'avant ou bien, grâce à un ventilateur centrifuge, la canaliser dans plusieurs pièces.

En función de la versión, nuestros Ecopalex® pueden ventilar el aire por las rejillas frontales o también, gracias a un ventilador centrifugo, canalizarlo a varias habitaciones.







### *Registro aria comburente* **3**

consente di gestire la combustione e controllare i consumi, assicurando un'alta resa e un sicuro risparmio.

**Combustion air register**  
it manages combustion thus controlling consumptions and ensuring a high output and guaranteed savings.

**Registre de l'air comburant**  
il permet de gérer la combustion et de contrôler les consommations, en obtenant une haute performance et en réalisant des économies.

**Registro de aire comburente**  
permite controlar la combustión y los consumos, asegurando alto rendimiento y ahorro seguro.



### *Cassetto cenere* **4**

capiente ed estraibile per una facile pulizia.

**Ash drawer**  
large and removable for easy cleaning.

**Tiroir à cendres**  
de grande contenance et amovible pour un nettoyage.

**Cajón de la ceniza**  
de gran capacidad y extraíble para una fácil limpieza.



### *Sistema pulizia vetro* **5**

un'apposito registro regola l'afflusso dell'aria che lambisce il vetro della portina, evitando così il depositarsi di fuliggine e la formazione di aloni, per una costante nitida visione della fiamma.

**Glass cleaning system**  
a special regulator adjusts the quantity of air that brushes over the glass door, preventing soot from depositing and stains from forming for a constantly clear view of the fire.

**Système de nettoyage de la vitre**  
afin que le feu soit toujours clairement visible, un registre règle l'arrivée de l'air qui balaye la vitre de la porte et qui empêche que la suie ne s'y dépose ou qu'il ne se forme des auroles.

**Sistema de limpieza del vidrio**  
un registro expreso va ajustando el caudal de aire que alcanza el vidrio de la puerta, así que se evita el depósito de hollín y la formación de marcas, para una constante y clara visión de la llama.



### *Ecoforno®* **6**

è un forno in acciaio inox che funziona senza gas, nè elettricità, nè legna, perchè, grazie ad un brevetto, si scalda rapidamente sfruttando il calore dei fumi in uscita dall'Ecopalex®.

**Ecoforno®**  
this is a stainless steel oven that needs neither gas, electricity nor wood to function because, thanks to a patented system, it heats up quickly by exploiting the heat of the fumes exiting the Ecopalex® firebox.

**Ecoforno®**  
il s'agit d'un four en acier inox qui fonctionne sans gaz ni électricité ni bois car, grâce à un système breveté, il chauffe rapidement en exploitant la chaleur des fumées sortant de l'Ecopalex®.

**Ecoforno®**  
es un horno de acero inox. que funciona sin gas, fluido eléctrico ni leña porque gracias a una patente, se calienta rápidamente aprovechando el calor de los humos de salida del Ecopalex®.

## *Ecopalex® Glass*



# INSERTO

*Un focolare che abbina elevate prestazioni ad un design in cui la fiamma è protagonista, proposto in due versioni a sviluppo orizzontale e verticale. La potenza termica dell'Inserto viene distribuita per irraggiamento, attraverso l'ampio vetro ceramico, e per convezione grazie al ventilatore attraverso un sistema di canalizzazione e bocchette per un calore sano ed uniforme in tutta la casa.*



INSERTO 45 PORTA PIANA



## INSERTO

*This firebox combines high performances with a design that focuses on the fire. It is available in two versions: a wide, horizontal one and a tall, vertical one. The thermal power of the insert is distributed by radiation, through a large ceramic glass door and by convection thanks to a fan that conveys the hot air through a system of ducts and vents to supply healthy, evenly-distributed heat throughout the home.*

## INSERTO

*Foyer alliant de hautes performances à un design où le feu joue la vedette. Il est proposé en deux versions : à développement horizontal ou à développement vertical. La puissance calorifique de l'Inserto est distribuée par rayonnement à travers la large vitre en verre céramique et, grâce au ventilateur, par convection à travers un système de canalisation et de bouches de soufflage, pour une chaleur saine et uniforme dans toute l'habitation.*

## INSERTO

*Un hogar que conjuga sus prestaciones elevadas con un diseño protagonizado por la llama, disponible en dos versiones, horizontal y vertical. La potencia térmica del Inserto se reparte por radiación, a través del amplio vidrio cerámico, y por convección gracias al ventilador mediante un sistema de canalización y boquillas, para un calor saludable y uniforme en toda la casa.*

### GAMMA

### FRONTALE

### TONDO

range  
gamme  
gama

frontal  
frontal  
frontal

round  
arrondi  
redondo

45

X

X

H66

X

H76

X





NOTTING HILL



INSERTO 45 PORTA TONDA



INSERTO H66NEW



INSERTO H76NEW

# APPROFONDIMENTO TECNICO

TECHNICAL SPECIFICATIONS. APPROFONDISSEMENT TECHNIQUE.  
PROFUNDIZACIÓN TÉCNICA.



INSERTO 45 ARIA.



## *Focolare in ghisa*

1

rivestito da oltre 75 kg di piastre in ghisa dall'eccezionale spessore di 9 mm garantisce resistenza, durata nel tempo ed elevati rendimenti.

### **Cast iron firebox**

covered with more than 75 kg of cast iron plates having an exceptional 9 mm thickness, it guarantees resistance, long-life and high performances.

### **Foyer en fonte**

revêtu avec plus de 75 kg de plaques en fonte d'une épaisseur exceptionnelle de 9 mm, il offre résistance, longévité et hauts rendements.

### **Hogar de hierro fundido**

recubierto con más de 75 kg de placas de hierro fundido con un grosor excepcional de 9 mm garantiza resistencia, durabilidad en el tiempo y elevados rendimientos.



## *Scambiatore di calore*

2

con possibilità di canalizzare l'aria calda attraverso i ventilatori in più ambienti.

### **Heat exchanger**

the hot air can be ducted by means of fans to distribute hot air to various rooms.

### **Échangeur de chaleur**

avec possibilité de canaliser l'air chaud dans plusieurs pièces au moyen des ventilateurs.

### **Intercambiador de calor**

con posibilidad de canalizar el aire caliente, gracias a los ventiladores, hacia más habitaciones.



### *Cassetto cenere*

3

capiente ed estraibile per una facile pulizia anche durante il funzionamento.

#### **Ash drawer**

large and removable for easy cleaning even while the fireplace is lit.

#### **Tiroir à cendres**

de grande contenance et amovible pour un nettoyage aisé même pendant le fonctionnement du foyer.

#### **Cajón de la ceniza**

de gran capacidad y extraíble para una fácil limpieza también durante el funcionamiento.



### *Registro aria pulizia vetro*

4

consente di regolare l'afflusso dell'aria, che, lambendo il vetro della portina, crea una barriera contro il deposito di fuliggine. È possibile gestire la regolazione in funzione della qualità della legna bruciata.

#### **Glass cleaning air register**

adjusts the flow of air which creates a barrier on the door to prevent soot from depositing on the glass. The air can be adjusted to suit the quality of the wood being burnt.

#### **Registre de l'air pour le nettoyage de la vitre**

il permet de réguler l'arrivée de l'air qui, en balayant la vitre de la porte, forme une barrière en évitant que la suie ne s'y dépose. Il est possible de le régler en fonction de la qualité du bois brûlé.

#### **Registro de aire para la limpieza del vidrio**

permite regular el caudal de aire que, al alcanzar el vidrio de la puerta, crea una barrera contra el depósito de hollín. Es posible regularlo en función de la calidad de la leña quemada.



### *Maniglia ergonomica*

5

è in gomma siliconica antiscottatura per facilitare l'apertura/chiusura della portina, in completa sicurezza.

#### **Ergonomic handle**

in cool-touch silicone rubber to make door opening/closing safe and easy.

#### **Poignée ergonomique**

elle est réalisée en caoutchouc silicone anti-brûlures pour faciliter l'ouverture/fermeture de la porte en toute sécurité.

#### **Manija ergonómica**

es de caucho de silicona a prueba de quemaduras para favorecer la apertura y el cierre de la puerta, con la máxima seguridad.



### *Portina in vetro ceramico*

6

ampia e panoramica, con sviluppo orizzontale o verticale, presenta un telaio essenziale con comandi nascosti per una suggestiva visione della fiamma. Il vetro è resistente a shock termici di 800° C.

#### **Ceramic glass door**

large and panoramic, either wide or tall, it has a minimalist frame with concealed controls to offer a bewitching view of the fire. The glass resists to thermal shocks of up to 800°C.

#### **Porte vitrée en verre céramique**

large et panoramique, à développement horizontal ou vertical, elle a un cadre à la ligne épurée et des commandes masquées pour une vision suggestive du feu. Le verre résiste à des chocs thermiques de 800°C.

#### **Puerta de vidrio cerámico**

amplia y panorámica, con desarrollo horizontal o vertical, cuenta con un marco esencial con mandos ocultos para la sugerente vista de la llama. El vidrio resiste los cambios térmicos hasta 800°.

# GAMMA IKI

Una stufa-camino in cui la purezza delle linee lascia la fiamma e il suo calore come unica protagonista. Tre le versioni proposte: orizzontale Iki 16:9, verticale Iki Up e quadrata Iki Square (possono essere anche rivestiti). La struttura in acciaio verniciato racchiude il focolare in Thermofix e viene fornito di serie con tecnologia O<sub>2</sub>Ring per l'abbattimento delle emissioni e l'aumento della resa.



**IKI 16:9 e Iki Square:**  
 apertura basculante della portina;  
 pull-out lift-up door;  
 ouverture basculante de la porte;  
 apertura elevable de la puerta.

**IKI UP:**  
 ha un sistema di "apertura e chiusura a battente assistita", che aiuta l'utente nelle fasi di ricarica;  
 has an effortless opening and closing system that makes loading wood logs a breeze;  
 il a un système « d'ouverture / fermeture assistée » de la porte qui aide l'utilisateur lorsqu'il effectue la charge ;  
 cuenta con un sistema de "apertura y cierre asistidos" que ayuda al usuario en la carga.



## IKI RANGE

A firebox-fireplace with such pure lines that the fire and its warmth becomes the undisputed main attraction. Three versions are available: Horizontal Iki 16:9, vertical Iki Up and square-shaped Iki Square (they can also be clad). The painted steel structure encloses the Thermofix firebox and comes standard with O<sub>2</sub>Ring technology that reduces polluting emissions and increase performances.

## GAMME IKI

Un foyer-cheminée où la pureté des lignes laisse le feu et sa chaleur jouer la vedette. Il est proposé en trois modèles au choix : horizontal Iki 16:9, vertical Iki Up et carré Iki Square (ils peuvent tous être revêtus d'un habillage). La structure en acier laqué renferme le foyer en Thermofix qui est fourni, en standard, avec la technologie O<sub>2</sub>Ring servant à réduire les émissions nocives et à augmenter les performances.

## GAMA IKI

Un hogar-chimenea donde las líneas limpias son protagonizadas por la llama y su calor. Las versiones disponibles son tres: horizontal Iki 16:9, vertical Iki Up y cuadrada Iki Square (también se pueden revestir). La estructura de acero pintado encierra el hogar de Thermofix y se entrega de serie con tecnología O<sub>2</sub>Ring para reducir las emisiones y potenciar el rendimiento.

### GAMMA

### FRONTALE

range gamme gama	frontal frontal frontal
IKI 16:9	X
IKI SQUARE	X
IKI UP	X





IKI 16:9



IKI UP



IKI SQUARE

# MULTIFIRE

*Focolare ideale per chi vuole coniugare tradizione e innovazione, riscaldamento a legna e praticità automatica del pellet. Multifire è il focolare che funziona sia a legna sia a pellet e può scaldare intere abitazioni con funzionamento ad aria.*



MULTIFIRE 45 PORTA TONDA

## MULTIFIRE

*This is the ideal firebox for those who want to combine tradition with innovation, a wood-burning product with the practicality of automatic pellet feed. Multifire is a wood or pellet-burning firebox that can heat entire homes using hot air.*

## MULTIFIRE

*Foyer idéal pour ceux qui veulent allier la tradition à l'innovation, le chauffage au bois à la praticité automatique des pellets. Multifire peut être alimenté soit avec des bûches soit avec des pellets et peut chauffer des habitations entières avec un fonctionnement à circulation d'air.*

## MULTIFIRE

*Hogar ideal para quien quiere conjugar tradición e innovación, calefacción con leña y practicidad automática de los pellets. Multifire es el hogar que funciona tanto con leña como con pellets y puede calentar enteras viviendas con su funcionamiento por aire.*



680 m³/h



16,6  
KW



### GAMMA

range  
gamme  
gama

45

MULTIFIRE BIO

### PORTA PIANA

flat door  
porte plate  
puerta plana

X

X



### PORTA TONDA

rounded door  
porte arrondi  
puerta redonda

X







# APPROFONDIMENTO TECNICO

TECHNICAL SPECIFICATIONS. APPROFONDISSEMENT TECHNIQUE.  
PROFUNDIZACIÓN TÉCNICA.

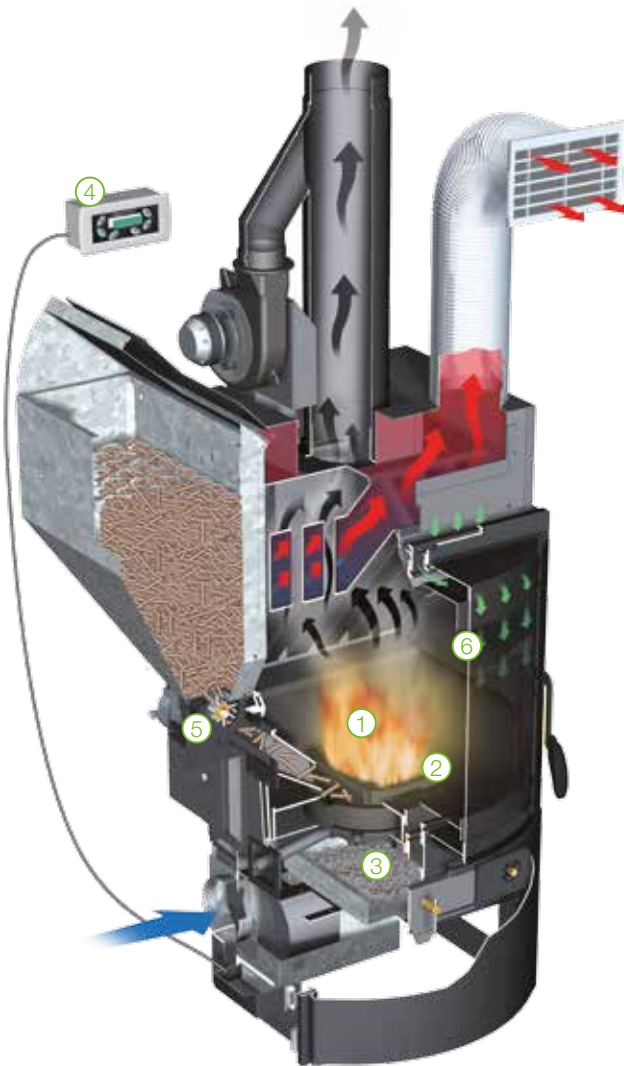

MULTIFIRE 45.



## *Focolare in ghisa* **1**

rivestito da oltre 75 kg di piastre in ghisa dall'eccezionale spessore di 9 mm riesce ad accumulare enormi quantità di calore, che poi viene ceduto all'ambiente progressivamente per irraggiamento e convezione.

### **Cast iron firebox**

covered with more than 75 kg of cast iron plates having an exceptional 9 mm thickness, it can store huge quantities of heat that is yielded slowly to the environment by radiation and convection.

### **Foyer en fonte**

revêtu avec plus de 75 kg de plaques en fonte d'une épaisseur exceptionnelle de 9 mm, il parvient à accumuler d'énormes quantités de chaleur qui sont ensuite progressivement cédées à la pièce par rayonnement et par convection.

### **Hogar de hierro fundido**

recubierto con más de 75 kg de placas de hierro fundido con un grosor excepcional de 9 mm llega a acumular cantidades enormes de calor, que luego es cedido al ambiente progresivamente por radiación y convección.



## *Brasiera brevettato* **2**

rotante e autopulente consente di bruciare indifferentemente legna o pellet. La griglia integrata, ribaltabile, migliora il funzionamento in modalità legna. Basta un semplice gesto per passare da una modalità di funzionamento all'altra.

### **Patented brazier**

it rotates and is self-cleaning and can burn either wood or pellets. The integrated, tilting grid improves operation in the wood-burning mode. A simple gesture is all that is required to go from one operating mode to the other.

### **Brasier breveté**

rotatif et autonettoyant, il permet de brûler indifféremment du bois ou des pellets. La grille intégrée et rabattable permet d'améliorer le fonctionnement en mode bois. Un simple geste suffit pour passer d'un mode de fonctionnement à l'autre.

### **Brasero con patente**

giratorio y autolimpiable, permite quemar indistintamente leña y pellets. La parrilla integrada, volcable, agiliza el funcionamiento con leña. Es suficiente un simple gesto para pasar de una a otra modalidad de funcionamiento.



### Cassetto cenere

3

capiente e facilmente estraibile. Abbinato al ciclo di pulizia con braciere automatico riduce la frequenza di pulizia da parte dell'utente.

#### Ash drawer:

large and easy to remove. When combined with the automatic brazier-cleaning cycle, it reduces the frequency of cleaning sessions.

#### Tiroir à cendres

de grande contenance et facilement amovible. Associé au cycle de nettoyage automatique du brasier, il réduit la fréquence de nettoyage de la part de l'utilisateur.

#### Cajón de la ceniza

de gran capacidad y fácilmente extraíble. En combinación con el ciclo de limpieza del brasero automático reduce la frecuencia de la limpieza de parte del usuario.



### Centralina elettronica

4

gestisce automaticamente: accensione, programmazione fasce orarie di funzionamento, combustione, modulazione di potenza, passaggio legna/pellet. Inoltre, nel funzionamento a pellet è possibile gestire automaticamente: alimentazione e pulizia braciere, riaccensione dopo black-out.

#### Electronic control unit

it automatically controls: ignition, programming of operating hours, combustion, power adjustment, switch-over from wood to pellet operation and vice-versa. Moreover, in the pellet-burning mode the following can be automatically controlled: feed and brazier cleaning, re-ignition after a power failure.

#### Centrale de commande électronique

elle permet de gérer en mode automatique les fonctions suivantes : mise en marche, programmation tranches horaires de fonctionnement, combustion, modulation de puissance, passage bois/pellets. En outre, en mode pellets, elle permet de gérer en mode automatique les fonctions suivantes : charge et nettoyage du brasier, rallumage après un black-out.

#### Centralita electrónica

controla automáticamente: encendido, programación de los horarios de funcionamiento, combustión, modulación de potencia, paso al funcionamiento con leña/pellets. Además, en el funcionamiento con pellets es posible controlar automáticamente: alimentación y limpieza del brasero, encendido después de un apagón.



### Caricamento pellet con sistema a Stella

5

garantisce un dosaggio costante favorendo una combustione regolare con massima resa e minime emissioni. Il funzionamento a rotazione consente di bruciare completamente anche le polveri di pellet, che altrimenti si accumulerebbero sul fondo del serbatoio richiedendo una maggiore manutenzione.

#### The "Star" pellet-feed system

ensures constant pellet feed for steady combustion with maximum performances and minimum emissions. Its rotating motion makes it possible to completely burn even the pellet dust that would otherwise collect at the bottom of the pellet box and require more maintenance.

#### Charge des pellets avec système à écluse

il permet un dosage constant des pellets et une combustion régulière en obtenant une performance maximale et de très basses émissions nocives. La rotation du brasier permet de brûler totalement même les poussières des pellets qui, autrement, s'accumuleraient dans le fond du réservoir nécessitant, dans tel cas, un plus grand nettoyage.

#### Carga de pellets con sistema en estrella

garantiza la dosificación constante favoreciendo la combustión regular con el máximo rendimiento y emisiones mínimas. El funcionamiento por rotación permite quemar completamente también los polvos de pellets, que de otra forma irían amontonándose en el fondo del depósito, precisando más mantenimiento.



### Sistema pulizia vetro

6

garantisce una nitida visione della fiamma, riducendo al minimo le operazioni di pulizia da parte dell'utente. Il vetro della portina viene costantemente lambito da un flusso d'aria che riduce la formazione di aloni ed il deposito della fuliggine.

#### Glass cleaning system

ensures a clear view of the fire and reduces cleaning sessions to a minimum. The glass door is constantly brushed by a flow of air that reduces the formation of stains and of soot deposits.

#### Système de nettoyage de la vitre

il permet de voir clairement le feu en réduisant au minimum les opérations de nettoyage de la part de l'utilisateur. La vitre de la porte est constamment balayée par un flux d'air qui réduit la formation d'auréoles et le dépôt de suie.

#### Sistema de limpieza del vidrio

garantiza la mejor visión de la llama, minimizando las operaciones de limpieza de parte del usuario. El vidrio de la puerta es alcanzado constantemente por un caudal de aire que reduce la formación de marcas y el depósito de hollín.

---

# MULTIFIRE BIO

---

*Multifire BIO presenta una tecnologia innovativa e completamente automatica sia nel funzionamento a pellet sia a legna.*



MULTIFIRE BIO

- Innovativo focolare con braciere basculante autopulente, con doppio funzionamento legna/pellet;
- possibilità di essere rivestito a piacimento;
- scambiatore di calore con triplo giro di fumi e fascio tubiero
- focolare in Magnofix con base in ghisa;
- vetro ceramico (800°) con sistema di autopulizia;
- display digitale con comandi a sfioramento;
- rilevazione automatica del tipo di combustibile e completa gestione della combustione;
- passaggio automatico da una modalità di funzionamento ad un'altra;
- accensione automatica e programmabile con entrambi i combustibili;
- tiraggio controllato anche nel funzionamento a legna.
- ventilatore radiale da 570 m<sup>3</sup>/h;
- possibilità di escludere la ventilazione per aumentare il comfort acustico;
- Connection Box per la gestione ed il controllo del focolare attraverso dispositivo mobile.

## MULTIFIRE BIO

*Multifire BIO uses innovative and fully automatic technology no matter whether it is fuelled by pellets or wood.*

- Innovative firebox with self-cleaning burn pot with tilt mechanism, dual, wood and pellet operation;
- can be clad as desired;
- innovative completely self-cleaning Multifire Bio firebox;
- heat exchanger with triple smoke path and tube nest
- Magnofix firebox with cast iron base;
- ceramic glass (800 ) with self-cleaning system;
- digital display with touch controls;
- automatic detection of type of fuel and thorough fuel management;
- automatic switch-over from one operating mode to the other;
- automatic and programmable ignition with both fuels;
- draught control even in the wood-burning mode.
- 570 m<sup>3</sup>/h radial fan;
- possibility of excluding fan operation to increase acoustic comfort;
- the Connection Box manages and controls the firebox by means of a mobile device.





NICOLAS - MULTIFIRE BIO

## MULTIFIRE BIO

*Qu'il fonctionne au bois ou avec des pellets, le Multifire BIO a une technologie innovante et entièrement automatique.*

- Innovant foyer avec brasero basculant autonettoyant, à fonctionnement mixte bois/pellets ;
- possibilité de l'habiller au choix ;
- innovant foyer Multifire Bio entièrement autonettoyant ;
- échangeur de chaleur avec triple parcours des fumées et faisceau tubulaire
- foyer en Magnofix avec embase en fonte ;
- vitre en verre céramique (800°C) avec système autonettoyant ;
- écran avec commandes à effleurement ;
- détection automatique du type de combustible et gestion complète de la combustion ;
- passage automatique d'un mode de fonctionnement à l'autre ;
- allumage automatique et programmable pour les deux combustibles ;
- contrôle du tirage même lorsqu'il fonctionne au bois.
- ventilateur radial de 570 m<sup>3</sup>/h ;
- possibilité d'exclure totalement la ventilation pour augmenter le confort acoustique ;
- Connection Box pour la gestion et le contrôle du foyer à travers un dispositif mobile.

## MULTIFIRE BIO

*Multifire BIO presenta una tecnología novedosa y completamente automática tanto en el funcionamiento con pellets como con leña.*

- Novedoso hogar con brasero basculante autolimpiable, con doble funcionamiento con leña/pellets;
- posibilidad de revestimiento a elegir;
- novedoso hogar completamente autolimpiable Multifire Bio;
- intercambiador de calor con triple giro de humos y haz de tubos;
- hogar de Magnofix con base de hierro fundido;
- vidrio cerámico (800°) autolimpiable;
- pantalla digital con mandos táctiles;
- detección automática del tipo de combustible y completo control de la combustión;
- paso automático de una a otra modalidad de funcionamiento;
- encendido automático y programable con ambos combustibles;
- tiro controlado también en el funcionamiento con leña.
- ventilador radial de 570 m<sup>3</sup>/h;
- posibilidad de excluir la ventilación para potenciar el confort acústico;
- Connection Box para el control del hogar mediante el móvil.

# ECOFIRE® DA INSERIMENTO & DA RIVESTIMENTO

*Focolare a pellet completamente automatico e programmabile, è ideale per essere inserito in caminetti preesistenti per migliorarne funzionalità e rendimento.*



ECOFIRE® DA INSERIMENTO CANALIZZABILE  
CON NUOVO VETRO ESTETICO  
DUCTABLE - PANORAMIC GLASS  
CANALISABLE - VERRE ESTHÉTIQUE  
CANALIZABLE - VIDRIO ESTÉTICO

## ECOFIRE® FOR BUILDING IN OR CLADDING

*A fully-automatic and programmable pellet-burning firebox, ideal for installation in existing fireplaces to improve their efficiency and performance.*

## ECOFIRE® À INTÉGRER ET POUR HABILLAGE

*Foyer à pellets entièrement automatique et programmable, il est idéal pour être installé dans des cheminées existantes afin d'en améliorer le fonctionnement et le rendement.*

## ECOFIRE® EMPOTRABLES Y PARA REVESTIMIENTOS

*Hogar de pellets completamente automático y programable, ideal para su incorporación a chimeneas existentes para mejorar su funcionamiento y rendimiento.*

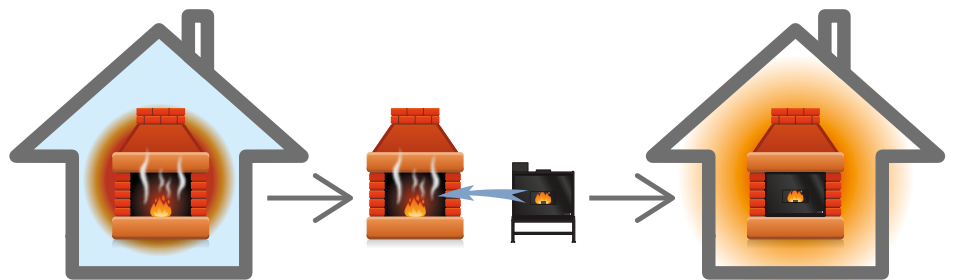

### New Design

Il frontale in vetro ceramico ha un design minimale per una suggestiva visione della fiamma.

The ceramic glass front has a minimal design for a bewitching view of the fire.

La façade en verre céramique a un design minimal pour une vision du feu suggestive.

El frente vidreocerámico tiene un diseño minimal para una sugerente visión de la llama.



MARRAKECH



ECOFIRE® DA INSERIMENTO  
VENTILAZIONE FRONTALE  
FRONT FAN  
VENTILATION FRONTALE  
VENTILACIÓN FRONTAL



ECOFIRE® SMALL 54



ECOFIRE®  
DA RIVESTIMENTO 9



ECOFIRE® DA RIVESTIMENTO 12  
CON DOPPIO VENTILATORE  
DOUBLE FAN  
2 VENTILATEURS  
DOBLE VENTILADOR

# APPROFONDIMENTO TECNICO

TECHNICAL SPECIFICATIONS. APPROFONDISSEMENT TECHNIQUE.  
PROFUNDIZACIÓN TÉCNICA.

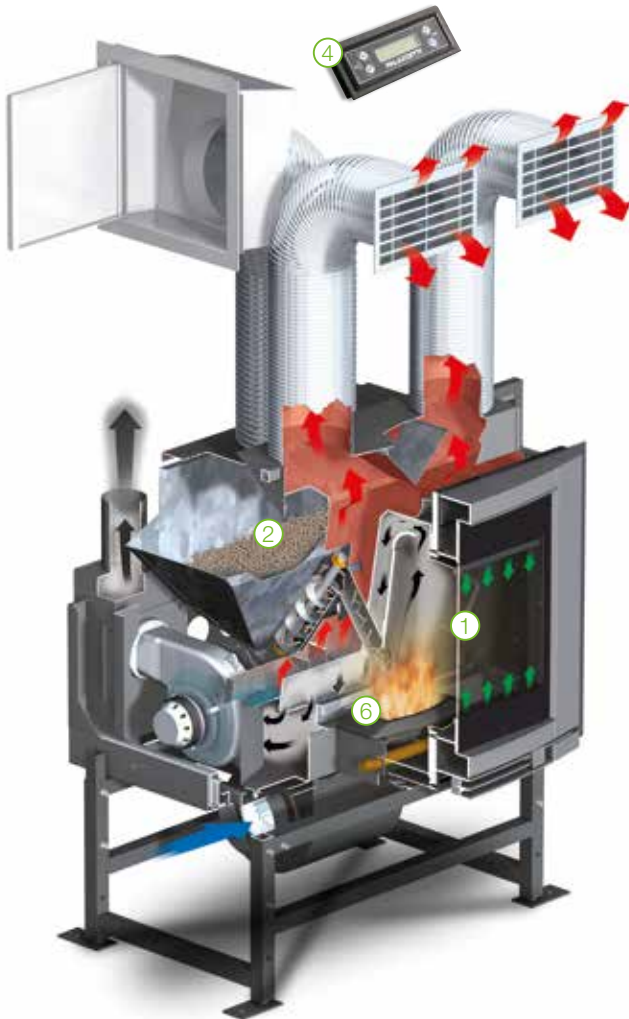

Ecofire® da Inserimento canalizzabile.  
Ecofire® for building in ductable. Ecofire® à intégrer canalisable. Ecofire® empotrable canalizable.



## Focolare e braciere in ghisa 1

l'elevato spessore della ghisa (7mm) garantisce resistenza, durata nel tempo ed elevati rendimenti.

**Cast iron firebox and brazier**  
the exceptional 7 mm thickness guarantees resistance, long-life and high performances.

**Foyer et brasier en fonte**  
la forte épaisseur de la fonte (7 mm) assure résistance, longévité et hauts rendements.

**Hogar y brasero de hierro fundido**  
el grosor elevado del hierro fundido (7mm) garantiza resistencia, durabilidad en el tiempo y altos rendimientos.



## Alimentazione automatica 2

il pellet, caricato nel capiente serbatoio, cade con frequenza costante nel braciere, alimentando la combustione e garantendo un'autonomia di funzionamento di molte ore. Un sensore di livello avverte l'utente quando il pellet sta per finire.

**Automatic feed**  
once the pellets have been fed into the large pellet box, the right quantity drops at regular intervals into the brazier to feed combustion and guarantee many hours of autonomous operation. A level sensor informs the user when the pellets are running out.

**Charge automatique**  
une fois que les pellets ont été chargés dans le grand réservoir, ceux-ci tombent dans le brasier avec une fréquence constante, en alimentant la combustion et en assurant une autonomie de chauffe pendant de nombreuses heures. Un capteur de niveau prévient l'utilisateur quand les pellets sont sur le point de se terminer.

**Alimentación automática**  
el pellet, una vez cargado en el depósito de gran capacidad, va cayendo en el brasero con frecuencia constante, alimentando la combustión y garantizando una autonomía de funcionamiento de muchas horas. Un sensor de nivel advierte al usuario cuando el pellet está a punto de agotarse.



Ecofire® da Inserimento Small con optional caricamento pellet da cassetto frontale.

Ecofire® Small for building in with optional front pellet feed drawer.

Ecofire® à intégrer Small avec, en option, charge des pellets depuis le tiroir avant.

Ecofire® empotrable Small con carga de pellets desde el cajón frontal opcional.





## Sonda ambiente

3

consente di raggiungere e mantenere costante la temperatura ambiente impostata sul pannello LCD. Il focolare gestirà autonomamente: la velocità del ventilatore/immissione aria calda, la potenza della combustione, agendo parallelamente sulla frequenza di caricamento pellets e sulla velocità ventilatore/espulsione fumi.

**The room temperature probe** makes it possible to reach and preserve the room temperature set on the LCD panel. The firebox will automatically control: the speed of the fan/introduction of hot air and the combustion power by simultaneously monitoring the pellet feed frequency and the fan/fumes discharge speed.

### Sonde d'ambiance

elle permet d'atteindre et de garder constante la température ambiante sélectionnée sur le tableau LCD. Le foyer gère en mode automatique les fonctions suivantes : la vitesse du ventilateur/sortie d'air chaud et la puissance de la combustion, en agissant parallèlement sur la fréquence de charge des pellets et sur la vitesse du ventilateur/expulseur des fumées.

### Sonda de ambiente

permite alcanzar y mantener constante la temperatura ambiente programada en la pantalla LCD. El hogar controla automáticamente: la velocidad del ventilador/inyección de aire caliente, la potencia de la combustión, actuando al mismo tiempo sobre la frecuencia de carga de los pellets y sobre la velocidad del ventilador/expulsión de los humos.



## Pannello LCD

4

gestisce tutte le funzioni automatizzate di Ecofire®, es.: accensione, spegnimento, programmazione delle fasce orarie di funzionamento sia su base giornaliera che settimanale (possibilità di creare diversi programmi personalizzati).

### The LCD panel

controls all the automatic Ecofire® functions, including: ignition, switch off, programming of operating hours on a daily and weekly bases (it is possible to create various personalised programmes).

### Tableau LCD

il permet de gérer toutes les fonctions automatisées de l'Ecofire® comme, par exemple : mise en marche, arrêt, tranches horaires de fonctionnement avec programmation journalière ou hebdomadaire (possibilité de créer plusieurs programmes personnalisés).

### Pantalla LCD

controla todas las funciones automáticas de Ecofire®, por ej.: encendido, apagado, programación de los horarios de funcionamiento, tanto a diario como semanalmente (es posible crear varios programas personalizados).



## App Palazzetti

5

I focolari Ecofire® sono predisposti per essere gestiti attraverso smartphone grazie alla App Palazzetti e alla Connection Box.

Thanks to the Palazzetti APP and the Connection Box, our Ecofire® fireboxes can be controlled directly from your smartphone.

Les foyers Ecofire® sont prévus pour être entièrement gérés depuis un smartphone grâce à l'App Palazzetti et à la Connection Box.

Los hogares Ecofire® están predisuestos para ser controlados mediante smartphone gracias a la App Palazzetti y a la Connection Box.



## Ciclo di pulizia braciere

6

automatico, si autoregola in funzione alla potenza selezionata. La metodica pulizia del braciere garantisce il funzionamento in costante regime di massimo rendimento con minimi consumi ed emissioni inquinanti, anche dopo molte ore.

### Brazier cleaning cycle

it is automatic and adjusts itself to the power selected. The methodical cleaning of the brazier ensures maximum heat-efficiency and minimum consumptions and polluting emissions, even after many hours of operation.

### Cycle de nettoyage du brasier

automatique, il se règle en fonction de la puissance sélectionnée. Ce nettoyage méthodique du brasier assure son fonctionnement à régime constant avec un rendement maximal et avec des consommations et des émissions polluantes très basses, même après de nombreuses heures.

### Ciclo de limpieza del brasero

automático, se autorregula en función de la potencia seleccionada. La limpieza puntual del brasero garantiza el funcionamiento en régimen constante de máximo rendimiento con consumos y emisiones contaminantes mínimos, incluso después de muchas horas.

# DATI TECNICI

TECHNICAL DATA. DONNEES TECHNIQUES. ESPECIFICACIONES TÉCNICAS.



**ECOMBL 45  
FRONTALE**

frontal  
frontal  
frontal



**ECOMBL 45  
TONDO**

round  
arrondi  
redondo



**ECOMBL 45  
BIFACCIALE**

double-fronted  
double façade  
bifacial

Dimensioni/peso Dimensions/weight  
Dimensions/poids Dimensiones/peso

57x54x156h cm  
205 kg

57x65x156h cm  
205 kg

59x61x163h cm  
205 kg

Potenza bruciata Heat input  
Puissance au foyer Potencia al hogar

kcal/h 12.040 - kW 14

kcal/h 12.040 - kW 14

kcal/h 12.700 - kW 14,8

Potenza globale (resa) Global heat output  
Puissance globale Potencia global

kcal/h 9.700 - kW 11,3

kcal/h 9.700 - kW 11,3

kcal/h 10.000 - kW 11,6

Rendimento Efficiency  
Rendement Rendimiento

80,2%

80,2%

78,1%

Elettroventilatore OPTIONAL Room fan  
Électro-ventilateur Ventilador eléctrico

350 m<sup>3</sup>/h

350 m<sup>3</sup>/h

350 m<sup>3</sup>/h

Uscita fumi Ø Exhaust outlet  
Sortie des fumées Salida de humos

20 cm\*

20 cm\*

20 cm\*

Presa d'aria esterna External air intake  
Prise d'air extérieur Toma de aire exterior

Ø15 cm\*\*

Ø15 cm\*\*

Ø15 cm\*\*

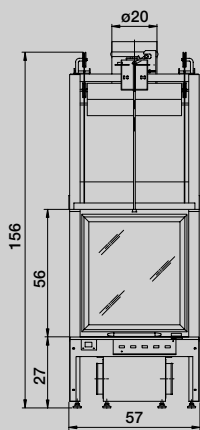

FRONTALE FRONTAL  
FRONTAL FRONTAL

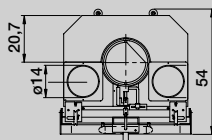

TONDO ROUND  
ARRONDI REDONDO

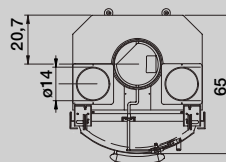

BIFACCIALE DOUBLE-FRONTED  
DOUBLE FAÇADE BIFACIAL

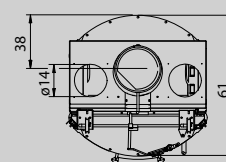



**ECOMBL 64**  
FRONTALE EASY LINE

**ECOMBL 64**  
DX/SX EASY LINE

**ECOMBL 64**  
EXAGONE EASY LINE

	frontal easy line frontal easy line frontal easy line	rh/lh Easy line d/g easy line derecho/izquierdo easy line	exagone easy line exagone easy line exagone easy line
Dimensioni/peso Dimensions/weight Dimensions/poids Dimensiones/peso	74x55x143h cm 160 kg	75x54x143h cm 160 kg	75x61x143h cm 177 kg
Potenza bruciata Heat input Puissance au foyer Potencia al hogar	kcal/h 14.800 - kW 17	kcal/h 14.800 - kW 17	kcal/h 14.800 - kW 17
Potenza globale (resa) Global heat output Puissance globale Potencia global	kcal/h 11.300 - kW 13	kcal/h 11.300 - kW 13	kcal/h 11.300 - kW 13
Rendimento Efficiency Rendement Rendimiento	>75%	>75%	>75%
Elettroventilatore OPTIONAL Room fan Électro-ventilateur Ventilador eléctrico	850 m³/h	850 m³/h	850 m³/h
Uscita fumi Ø Exhaust outlet Sortie des fumées Salida de humos	20 cm*	20 cm*	20 cm*
Presa d'aria esterna External air intake Prise d'air extérieur Toma de aire exterior	Ø15 cm**	Ø15 cm**	Ø15 cm**

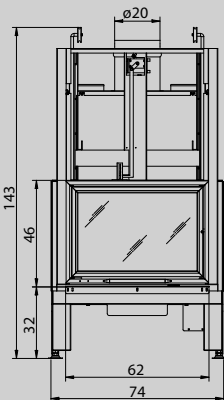

FRONTALE FRONTAL  
FRONTAL FRONTAL

DX/SX RH/LH  
D/G DERECHO/IZQUIERDO

EXAGONE EXAGONE  
EXAGONE EXAGONE

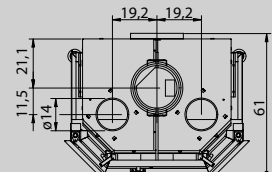
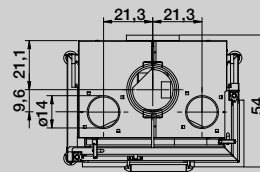
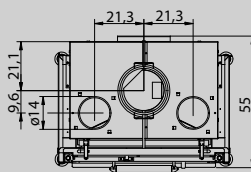

\*Approfondimento a pag. 66. \*More info on page 66. \*Approfondissement page 66. \*La profundización de la página 66.

\*\*In caso di canalizzazione della presa dell'aria, questa va aumentata di sezione (indicativamente 20% per ogni metro superiore al primo metro).

\*\*If the air intake is ducted, its cross-section must be increased (by approximately 20% for each metre bar the first one).

\*\* En cas de canalisation de la prise d'air, il faudra en augmenter la section (à titre indicatif, environ 20% pour chaque mètre au-delà du premier mètre).

\*\* En caso de canalización de la toma de aire, su sección se debe aumentar (un 20% aproximadamente por cada metro después del primero).



**ECOMBL 64**  
FRONTALE GHISA

**ECOMBL 64 V08**  
DX/SX GHISA

**ECOMBL 64 V08**  
EXAGONE GHISA

frontal cast iron  
frontal fonte  
frontal hierro fundido

rh/lh cast iron  
d/g fonte  
derecho/izquierdo Hierro fundido

exagone cast iron  
exagone fonte  
exagone Hierro fundido

Dimensioni/peso Dimensions/weight  
Dimensions/poids Dimensiones/peso

74x55x145h cm  
160 kg

74x55x145h cm  
160 kg

75x61x145h cm  
177 kg

Potenza bruciata Heat input  
Puissance au foyer Potencia al hogar

kcal/h 14.800 - kW 17

kcal/h 14.800 - kW 17

kcal/h 14.800 - kW 17

Potenza globale (resa) Global heat output  
Puissance globale Potencia global

kcal/h 11.300 - kW 13

kcal/h 11.300 - kW 13

kcal/h 11.300 - kW 13

Rendimento Efficiency  
Rendement Rendimiento

>75%

>75%

>75%

Elettroventilatore OPTIONAL Room fan  
Électro-ventilateur Ventilador eléctrico

850 m³/h

850 m³/h

850 m³/h

Uscita fumi Ø Exhaust outlet  
Sortie des fumées Salida de humos

20 cm\*

20 cm\*

20 cm\*

Presa d'aria esterna External air intake  
Prise d'air extérieur Toma de aire exterior

Ø15 cm\*\*

Ø15 cm\*\*

Ø15 cm\*\*

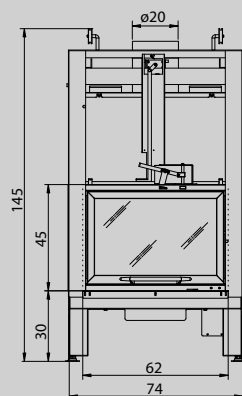

FRONTALE FRONTAL  
FRONTAL FRONTAL

DX/SX RH/LH  
D/G DERECHO/IZQUIERDO

EXAGONE EXAGONE  
EXAGONE EXAGONE

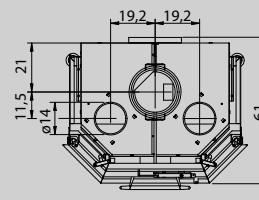
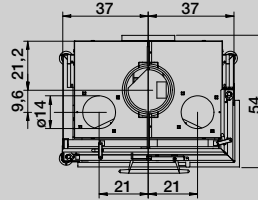
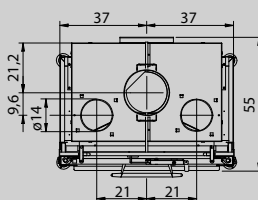



**ECOMBL 66**  
FRONTALE GHISA

**ECOMBL 66 V08**  
EXAGONE GHISA

**ECOMBL 66 V08**  
TONDO GHISA

frontal cast iron  
frontal fonte  
frontal hierro fundido

exagone cast iron  
exagone fonte  
exagone hierro fundido

round cast iron  
arrondi fonte  
redondo hierro fundido

Dimensioni/peso Dimensions/weight  
Dimensions/poids Dimensiones/peso

74x55x167h cm  
190 kg

74x61x167h cm  
190 kg

74x65x167h cm  
190 kg

Potenza bruciata Heat input  
Puissance au foyer Potencia al hogar

kcal/h 17.200 - kW 20

kcal/h 17.200 - kW 20

kcal/h 17.200 - kW 20

Potenza globale (resa) Global heat output  
Puissance globale Potencia global

kcal/h 12.650 - kW 14,7

kcal/h 12.650 - kW 14,7

kcal/h 12.650 - kW 14,7

Rendimento Efficiency  
Rendement Rendimiento

~73%

~73%

~73%

Elettroventilatore OPTIONAL Room fan  
Électro-ventilateur Ventilador eléctrico

850 m<sup>3</sup>/h

850 m<sup>3</sup>/h

850 m<sup>3</sup>/h

Uscita fumi Ø Exhaust outlet  
Sortie des fumées Salida de humos

20 cm\*

20 cm\*

20 cm\*

Presa d'aria esterna External air intake  
Prise d'air extérieur Toma de aire exterior

Ø15 cm\*\*

Ø15 cm\*\*

Ø15 cm\*\*

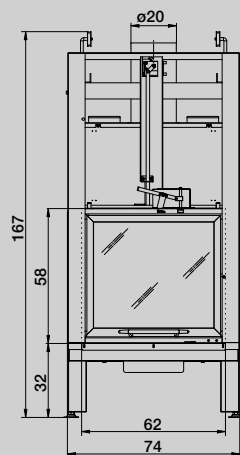

FRONTALE FRONTAL  
FRONTAL FRONTAL

EXAGONE EXAGONE  
EXAGONE EXAGONE

TONDO ROUND  
ARRONDI REDONDO

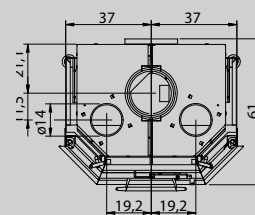
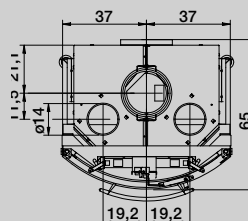
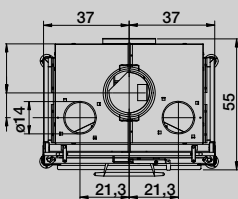

\*Approfondimento a pag. 66. \*More info on page 66. \*Approfondissement page 66. \*La profundización de la página 66.

\*\*In caso di canalizzazione della presa dell'aria, questa va aumentata di sezione (indicativamente 20% per ogni metro superiore al primo metro).

\*\*If the air intake is ducted, its cross-section must be increased (by approximately 20% for each metre bar the first one).

\*\* En cas de canalisation de la prise d'air, il faudra en augmenter la section (à titre indicatif, environ 20% pour chaque mètre au-delà du premier mètre).

\*\* En caso de canalización de la toma de aire, su sección se debe aumentar (un 20% aproximadamente por cada metro después del primero).



**ECOMBL 66**  
FRONTALE MAGNOFIX

**ECOMBL 66 V08-S**  
EXAGONE MAGNOFIX

**ECOMBL 66 V08-S**  
TONDO MAGNOFIX

frontal magnofix  
frontal magnofix  
frontal magnofix

exagone magnofix  
exagone magnofix  
exagone magnofix

round magnofix  
arrondi magnofix  
redondo magnofix

Dimensioni/peso Dimensions/weight Dimensions/poids Dimensiones/peso	74x55x167h cm 175 kg	74x61x167h cm 200 kg	74x65x167h cm 180 kg
Potenza bruciata Heat input Puissance au foyer Potencia al hogar	kcal/h 15.000 - kW 17,4	kcal/h 15.000 - kW 17,4	kcal/h 15.000 - kW 17,4
Potenza globale (resa) Global heat output Puissance globale Potencia global	kcal/h 11.700 - kW 13,6	kcal/h 11.700 - kW 13,6	kcal/h 11.700 - kW 13,6
Rendimento Efficiency Rendement Rendimiento	~78%	~78%	~78%
Elettroventilatore OPTIONAL Room fan Électro-ventilateur Ventilador eléctrico	850 m³/h	850 m³/h	850 m³/h
Uscita fumi Ø Exhaust outlet Sortie des fumées Salida de humos	20 cm*	20 cm*	20 cm*
Presa d'aria esterna External air intake Prise d'air extérieur Toma de aire exterior	Ø15 cm**	Ø15 cm**	Ø15 cm**

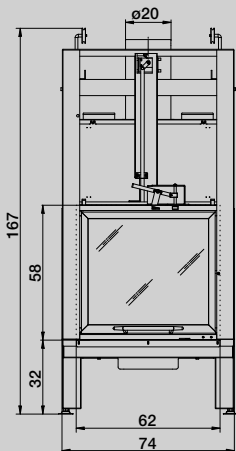

FRONTALE FRONTAL  
FRONTAL FRONTAL

EXAGONE EXAGONE  
EXAGONE EXAGONE

TONDO ROUND  
ARRONDI REDONDO

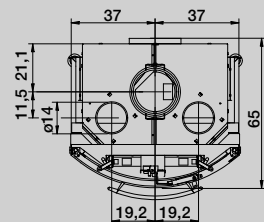
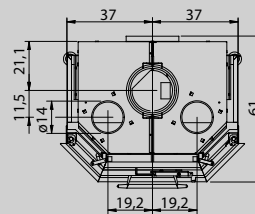
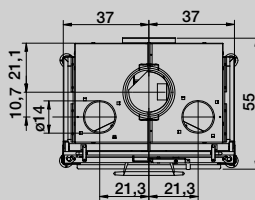

\*Approfondimento a pag. 66. \*More info on page 66. \*Approfondissement page 66. \*La profundización de la página 66.

\*\*In caso di canalizzazione della presa dell'aria, questa va aumentata di sezione (indicativamente 20% per ogni metro superiore al primo metro).

\*\*If the air intake is ducted, its cross-section must be increased (by approximately 20% for each metre bar the first one).

\*\* En cas de canalisation de la prise d'air, il faudra en augmenter la section (à titre indicatif, environ 20% pour chaque mètre au-delà du premier mètre).

\*\* En caso de canalización de la toma de aire, su sección se debe aumentar (un 20% aproximadamente por cada metro después del primero).



**ECOMBL 66**  
TONDO 180° GHISA

**ECOMBL S66**  
FRONTALE 3D MAGNOFIX

**ECOMBL 66**  
BIFACCIALE TONDO

round 180° cast iron  
arrondi 180° fonte  
redondo 180° hierro fundido

frontal 3D magnofix  
frontal 3D magnofix  
frontal 3D magnofix

round double-fronted  
double façade arrondi  
bifacial redondo

Dimensioni/peso Dimensions/weight  
Dimensions/poids Dimensiones/peso

73x73x167h cm  
213 kg

58x74x176h cm  
240 kg

94x54x165h cm  
215 kg

Potenza bruciata Heat input  
Puissance au foyer Potencia al hogar

kcal/h 18.900 - kW 22

kcal/h 15.500 - kW 18

kcal/h 18.000 - kW 21

Potenza globale (resa) Global heat output  
Puissance globale Potencia global

kcal/h 15.000 - kW 17,5

kcal/h 12.500 - kW 14,6

kcal/h 14.800 - kW 17,2

Rendimento Efficiency  
Rendement Rendimiento

~79,7%

~80,8%

~81,2%

Elettroventilatore OPTIONAL Room fan  
Électro-ventilateur Ventilador eléctrico

850 m³/h

850 m³/h

850 m³/h

Uscita fumi Ø Exhaust outlet  
Sortie des fumées Salida de humos

20 cm\*

25 cm\*

20 cm\*

Presa d'aria esterna External air intake  
Prise d'air extérieur Toma de aire exterior

Ø15 cm\*\*

Ø15 cm\*\*

Ø15 cm\*\*

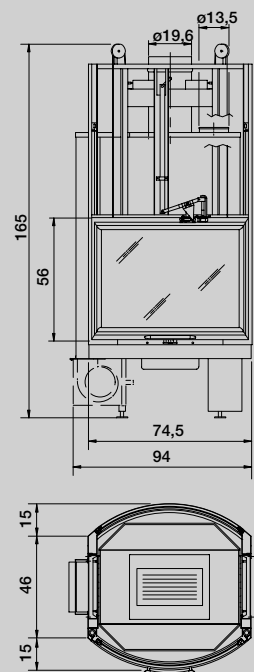
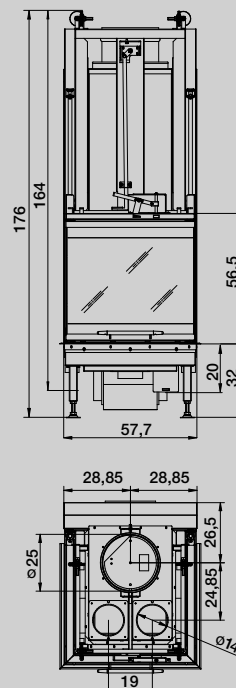
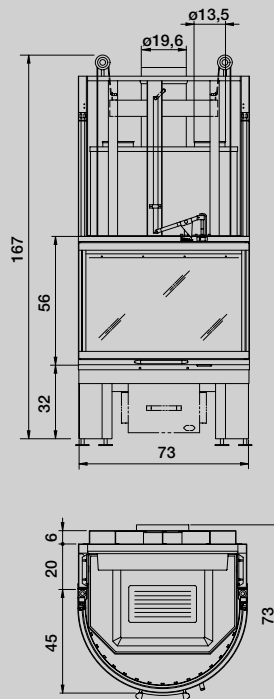



**ECOMBL 78**  
FRONTALE EASY LINE

**ECOMBL 78**  
DX/SX EASY LINE

**ECOMBL 78**  
EXAGONE EASY LINE

frontal easy line  
frontal easy line  
frontal easy line

rh/lh easy line  
d/g easy line  
derecho/izquierdo easy line

exagone easy line  
exagone easy line  
exagone easy line

Dimensioni/peso Dimensions/weight  
Dimensions/poids Dimensiones/peso

86x55x166h cm  
240 kg

85,5x55x166h cm  
205 kg

89x67x160h cm  
205 kg

Potenza bruciata Heat input  
Puissance au foyer Potencia al hogar

kcal/h 20.600 - kW 24

kcal/h 20.600 - kW 24

kcal/h 20.600 - kW 24

Potenza globale (resa) Global heat output  
Puissance globale Potencia global

kcal/h 15.300 - kW 17,8

kcal/h 15.300 - kW 17,8

kcal/h 15.300 - kW 17,8

Rendimento Efficiency  
Rendement Rendimiento

~73,2%

~73,2%

~73,2%

Elettroventilatore OPTIONAL Room fan  
Électro-ventilateur Ventilador eléctrico

850 m<sup>3</sup>/h

850 m<sup>3</sup>/h

850 m<sup>3</sup>/h

Uscita fumi Ø Exhaust outlet  
Sortie des fumées Salida de humos

25 cm\*

25 cm\*

25 cm\*

Presa d'aria esterna External air intake  
Prise d'air extérieur Toma de aire exterior

Ø15 cm\*\*

Ø15 cm\*\*

Ø15 cm\*\*

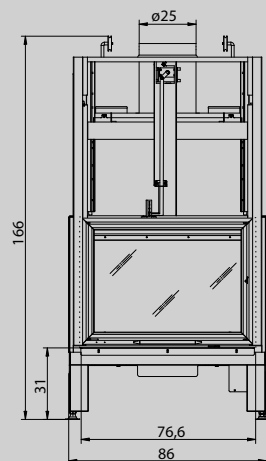

FRONTALE FRONTAL  
FRONTAL FRONTAL

DX/SX RH/LH  
D/G DERECHO/IZQUIERDO

EXAGONE EXAGONE  
EXAGONE EXAGONE

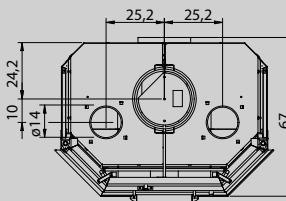
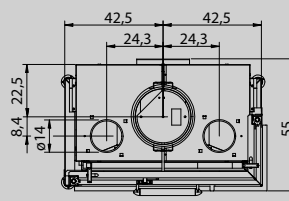
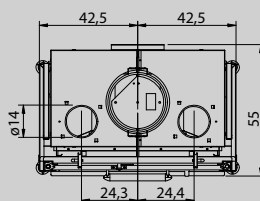





**ECOMBL EM78**  
FRONTALE GHISA

**ECOMBL 78 V08**  
DX/SX GHISA

**ECOMBL 78 V08**  
EXAGONE GHISA

	frontal cast iron frontal fonte frontal hierro fundido	rh/lh cast iron d/g fonte derecho/izquierdo hierro fundido	exagone cast iron exagone fonte exagone hierro fundido
Dimensioni/peso Dimensions/weight Dimensions/poids Dimensiones/peso	85x55x165h cm 215 kg	85x55x165h cm 215 kg	89x65x160h cm 215 kg
Potenza bruciata Heat input Puissance au foyer Potencia al hogar	kcal/h 18.600 - kW 21,6	kcal/h 18.600 - kW 21,6	kcal/h 18.600 - kW 21,6
Potenza globale (resa) Global heat output Puissance globale Potencia global	kcal/h 13.800 - kW 16,1	kcal/h 13.800 - kW 16,1	kcal/h 13.800 - kW 16,1
Rendimento Efficiency Rendement Rendimiento	~74,3%	~74,3%	~74,3%
Elettroventilatore OPTIONAL Room fan Électro-ventilateur Ventilador eléctrico	850 m³/h	850 m³/h	850 m³/h
Uscita fumi Ø Exhaust outlet Sortie des fumées Salida de humos	25 cm*	25 cm*	25 cm*
Presa d'aria esterna External air intake Prise d'air extérieur Toma de aire exterior	Ø15 cm**	Ø15 cm**	Ø15 cm**

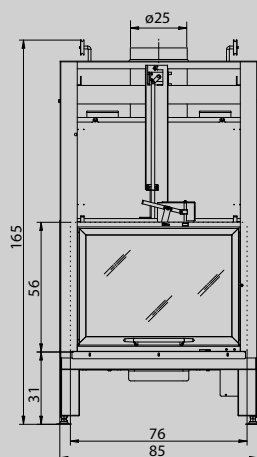

FRONTALE FRONTAL  
FRONTAL FRONTAL

DX/SX RH/LH  
D/G DERECHO/IZQUIERDO

EXAGONE EXAGONE  
EXAGONE EXAGONE

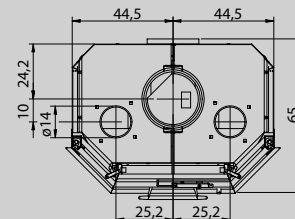
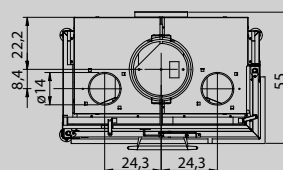
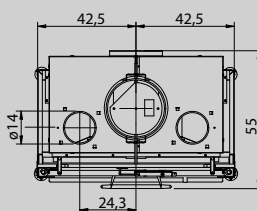

\*Approfondimento a pag. 66. \*More info on page 66. \*Approfondissement page 66. \*La profundización de la página 66.

\*\*In caso di canalizzazione della presa dell'aria, questa va aumentata di sezione (indicativamente 20% per ogni metro superiore al primo metro).

\*\*If the air intake is ducted, its cross-section must be increased (by approximately 20% for each metre bar the first one).

\*\* En cas de canalisation de la prise d'air, il faudra en augmenter la section (à titre indicatif, environ 20% pour chaque mètre au-delà du premier mètre).

\*\* En caso de canalización de la toma de aire, su sección se debe aumentar (un 20% aproximadamente por cada metro después del primero).



**ECOMBL EM78**  
FRONTALE MAGNOFIX

**ECOMBL 78 V08-S**  
DX/SX MAGNOFIX

**ECOMBL 78 V08-S**  
EXAGONE MAGNOFIX

frontal magnofix  
frontal magnofix  
frontal magnofix

rh/lh magnofix  
d/g magnofix  
derecho/izquierdo magnofix

exagone magnofix  
exagone magnofix  
exagone magnofix

Dimensioni/peso Dimensions/weight  
Dimensions/poids Dimensiones/peso

85x55x165h cm  
210 kg

85x55x165h cm  
210 kg

89x65x162h cm  
210 kg

Potenza bruciata Heat input  
Puissance au foyer Potencia al hogar

kcal/h 16.400 - kW 19

kcal/h 16.400 - kW 19

kcal/h 16.400 - kW 19

Potenza globale (resa) Global heat output  
Puissance globale Potencia global

kcal/h 13.100 - kW 15,2

kcal/h 13.100 - kW 15,2

kcal/h 13.100 - kW 15,2

Rendimento Efficiency  
Rendement Rendimiento

~80%

~80%

~80%

Elettroventilatore OPTIONAL Room fan  
Électro-ventilateur Ventilador eléctrico

850 m³/h

850 m³/h

850 m³/h

Uscita fumi Ø Exhaust outlet  
Sortie des fumées Salida de humos

25 cm\*

25 cm\*

25 cm\*

Presa d'aria esterna External air intake  
Prise d'air extérieur Toma de aire exterior

Ø15 cm\*\*

Ø15 cm\*\*

Ø15 cm\*\*

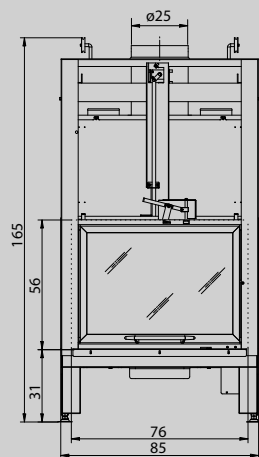

FRONTALE FRONTAL  
FRONTAL FRONTAL

DX/SX RH/LH  
D/G DERECHO/IZQUIERDO

EXAGONE EXAGONE  
EXAGONE EXAGONE

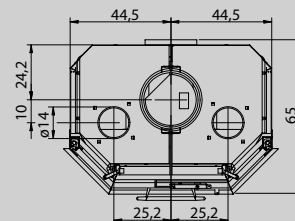
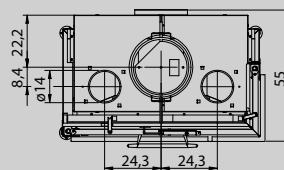
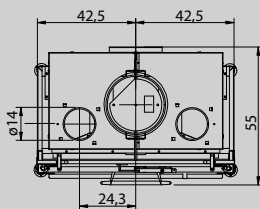

\*Approfondimento a pag. 66. \*More info on page 66. \*Approfondissement page 66. \*La profundización de la página 66.

\*\*In caso di canalizzazione della presa dell'aria, questa va aumentata di sezione (indicativamente 20% per ogni metro superiore al primo metro).

\*\*If the air intake is ducted, its cross-section must be increased (by approximately 20% for each metre bar the first one).

\*\* En cas de canalisation de la prise d'air, il faudra en augmenter la section (à titre indicatif, environ 20% pour chaque mètre au-delà du premier mètre).

\*\* En caso de canalización de la toma de aire, su sección se debe aumentar (un 20% aproximadamente por cada metro después del primero).



**ECOMBL S78 3D**  
FRONTALE MAGNOFIX

frontal magnofix  
frontal magnofix  
frontal magnofix

Dimensioni/peso Dimensions/weight  
Dimensions/poids Dimensiones/peso

82x73x168h cm  
290 kg

Potenza bruciata Heat input  
Puissance au foyer Potencia al hogar

kcal/h 19.300 - kW 22,4

Potenza globale (resa) Global heat output  
Puissance globale Potencia global

kcal/h 15.100 - kW 17,6

Rendimento Efficiency  
Rendement Rendimiento

~78,5%

Elettroventilatore OPTIONAL Room fan  
Électro-ventilateur Ventilador eléctrico

850 m<sup>3</sup>/h

Uscita fumi Ø Exhaust outlet  
Sortie des fumées Salida de humos

25 cm\*

Presa d'aria esterna External air intake  
Prise d'air extérieur Toma de aire exterior

Ø15 cm\*\*



**ECOMBL EM78**  
BIFACCIALE MAGNOFIX

double-fronted magnofix  
double façade magnofix  
bifacial magnofix

94x54x157/165h cm  
215 kg

kcal/h 19.300 - kW 22,4

kcal/h 14.800 - kW 17,2

~76,8%

850 m<sup>3</sup>/h

25 cm\*

Ø15 cm\*\*

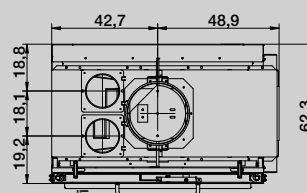
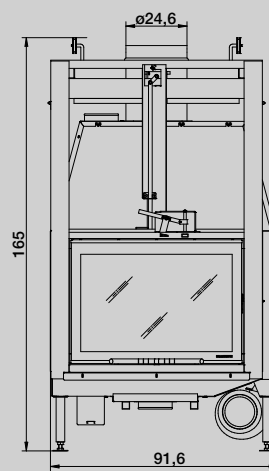
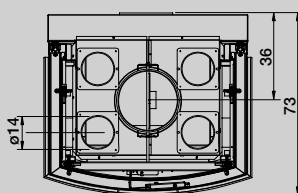
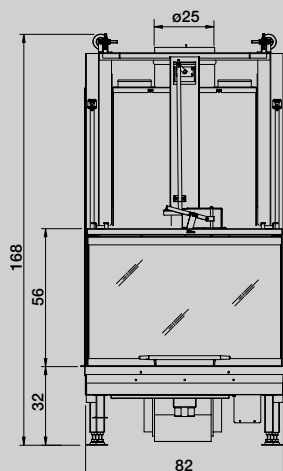



**ECOMBL 86**  
FRONTALE EASY LINE

frontal easy line  
frontal easy line  
frontal easy line



**ECOMBL 86**  
DX/SX EASY LINE

rh/lh easy line  
d/g easy line  
derecho/izquierdo easy line

Dimensioni/peso Dimensions/weight Dimensions/poids Dimensiones/peso	<b>100x67x165h cm</b> <b>230 kg</b>	<b>101x68x166h cm</b> <b>230 kg</b>
Potenza bruciata Heat input Puissance au foyer Potencia al hogar	<b>kcal/h 23.200 - kW 27</b>	<b>kcal/h 23.200 - kW 27</b>
Potenza globale (resa) Global heat output Puissance globale Potencia global	<b>kcal/h 17.200 - kW 20</b>	<b>kcal/h 17.200 - kW 20</b>
Rendimento Efficiency Rendement Rendimiento	<b>~73,7%</b>	<b>~73,7%</b>
Elettroventilatore OPTIONAL Room fan Électro-ventilateur Ventilador eléctrico	<b>850 m³/h</b>	<b>850 m³/h</b>
Uscita fumi Ø Exhaust outlet Sortie des fumées Salida de humos	<b>25 cm*</b>	<b>25 cm*</b>
Presa d'aria esterna External air intake Prise d'air extérieur Toma de aire exterior	<b>Ø20 cm**</b>	<b>Ø20 cm**</b>

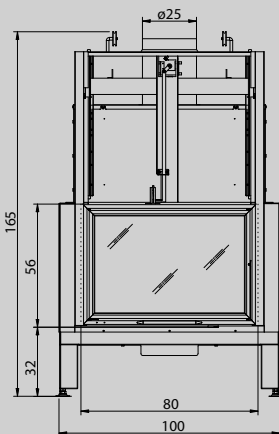

FRONTALE FRONTAL  
FRONTAL FRONTAL

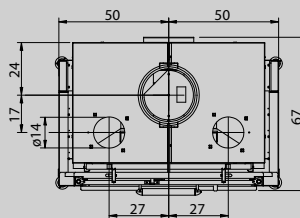

DX/SX RH/LH  
D/G DERECHO/IZQUIERDO

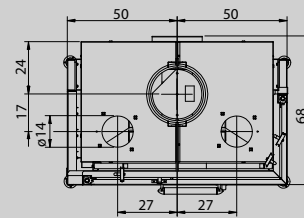



**ECOMBL EM86**  
FRONTALE GHISA

frontale cast iron  
frontale fonte  
frontale hierro fundido

Dimensioni/peso Dimensions/weight  
Dimensions/poids Dimensiones/peso

100x67x166h cm  
211 kg

Potenza bruciata Heat input  
Puissance au foyer Potencia al hogar

kcal/h 30.800 - kW 35,8

Potenza globale (resa) Global heat output  
Puissance globale Potencia global

kcal/h 22.800 - kW 26,5

Rendimento Efficiency  
Rendement Rendimiento

~74%

Elettroventilatore OPTIONAL Room fan  
Électro-ventilateur Ventilador eléctrico

850 m<sup>3</sup>/h

Uscita fumi Ø Exhaust outlet  
Sortie des fumées Salida de humos

25 cm\*

Presa d'aria esterna External air intake  
Prise d'air extérieur Toma de aire exterior

Ø20 cm\*\*



**ECOMBL 86 V08**  
DX/SX GHISA

rh/lh cast iron  
d/g fonte  
derecho/izquierdo hierro fundido

100x67x166h cm  
211 kg

kcal/h 30.800 - kW 35,8

kcal/h 22.800 - kW 26,5

~74%

850 m<sup>3</sup>/h

25 cm\*

Ø20 cm\*\*

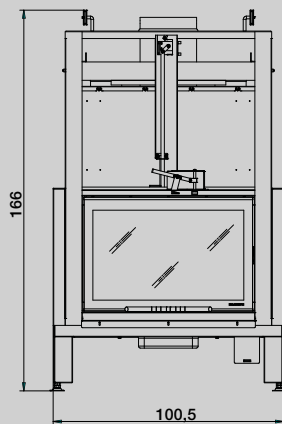

FRONTALE FRONTAL  
FRONTAL FRONTAL

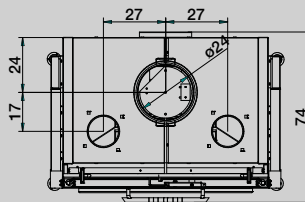

DX/SX RH/LH  
D/G DERECHO/IZQUIERDO

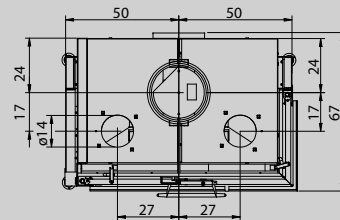

\*Approfondimento a pag. 66. \*More info on page 66. \*Approfondissement page 66. \*La profundización de la página 66.

\*\*In caso di canalizzazione della presa dell'aria, questa va aumentata di sezione (indicativamente 20% per ogni metro superiore al primo metro).

\*\*If the air intake is ducted, its cross-section must be increased (by approximately 20% for each metre bar the first one).

\*\* En cas de canalisation de la prise d'air, il faudra en augmenter la section (à titre indicatif, environ 20% pour chaque mètre au-delà du premier mètre).

\*\* En caso de canalización de la toma de aire, su sección se debe aumentar (un 20% aproximadamente por cada metro después del primero).



**ECOMBL EM86**  
FRONTALE MAGNOFIX

frontal magnofix  
frontal magnofix  
frontal magnofix

Dimensioni/peso Dimensions/weight  
Dimensions/poids Dimensiones/peso

100x67x166h cm  
240 kg

Potenza bruciata Heat input  
Puissance au foyer Potencia al hogar

kcal/h 22.000 - kW 25,6

Potenza globale (resa) Global heat output  
Puissance globale Potencia global

kcal/h 17.300 - kW 20,1

Rendimento Efficiency  
Rendement Rendimiento

~78,4%

Elettroventilatore OPTIONAL Room fan  
Electro-ventilateur Ventilador eléctrico

850 m<sup>3</sup>/h

Uscita fumi Ø Exhaust outlet  
Sortie des fumées Salida de humos

25 cm\*

Presa d'aria esterna External air intake  
Prise d'air extérieur Toma de aire exterior

Ø20 cm\*\*



**ECOMBL 86 V08-S**  
DX/SX MAGNOFIX

rh/lh magnofix  
d/g magnofix  
derecho/izquierdo magnofix

100x67x166h cm  
240 kg

kcal/h 22.000 - kW 25,6

kcal/h 17.300 - kW 20,1

~78,4%

850 m<sup>3</sup>/h

25 cm\*

Ø20 cm\*\*

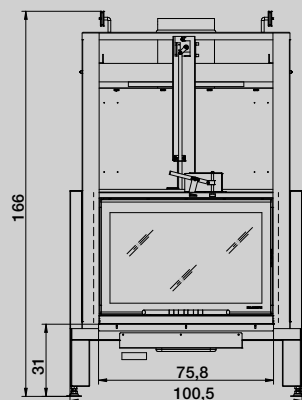

FRONTALE FRONTAL  
FRONTAL FRONTAL

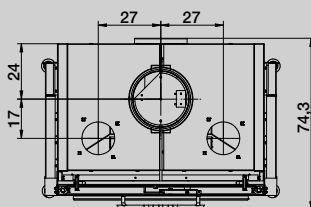

DX/SX RH/LH  
D/G DERECHO/IZQUIERDO

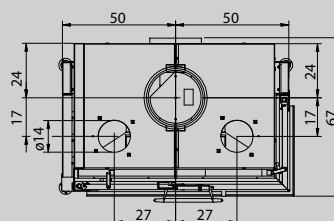

\*Approfondimento a pag. 66. \*More info on page 66. \*Approfondissement page 66. \*La profundización de la página 66.

\*\*In caso di canalizzazione della presa dell'aria, questa va aumentata di sezione (indicativamente 20% per ogni metro superiore al primo metro).

\*\*If the air intake is ducted, its cross-section must be increased (by approximately 20% for each metre bar the first one).

\*\* En cas de canalisation de la prise d'air, il faudra en augmenter la section (à titre indicatif, environ 20% pour chaque mètre au-delà du premier mètre).

\*\* En caso de canalización de la toma de aire, su sección se debe aumentar (un 20% aproximadamente por cada metro después del primero).



**ECOMBL EM16:9**  
FRONTALE GHISA

frontale cast iron  
frontale fonte  
frontale hierro fundido

**ECOMBL EM16:9**  
BIFACCIALE MAGNOFIX

double-fronted magnofix  
double façade magnofix  
bifacial magnofix

**ECOMBL EM16:9**  
3D

magnofix  
magnofix  
magnofix

Dimensioni/peso Dimensions/weight Dimensions/poids Dimensiones/peso	103x54x155h cm 240 kg	109x56x155h cm 240 kg	104x63x158h cm 235 kg
Potenza bruciata Heat input Puissance au foyer Potencia al hogar	kcal/h 21.500 - kW 25	kcal/h 20.600 - kW 24	kcal/h 22.700 kcal/h - kW 26,41
Potenza globale (resa) Global heat output Puissance globale Potencia global	kcal/h 16.400 - kW 19	kcal/h 16.000 - kW 18,7	kcal/h 17.200 - kW 20
Rendimento Efficiency Rendement Rendimiento	~76%	~78,2%	75,93%
Elettroventilatore OPTIONAL Room fan Électro-ventilateur Ventilador eléctrico	680 m <sup>3</sup> /h	680 m <sup>3</sup> /h	680 m <sup>3</sup> /h
Uscita fumi Ø Exhaust outlet Sortie des fumées Salida de humos	25 cm*	25 cm*	25 cm*
Presa d'aria esterna External air intake Prise d'air extérieur Toma de aire exterior	Ø15 cm**	Ø15 cm**	Ø15 cm**

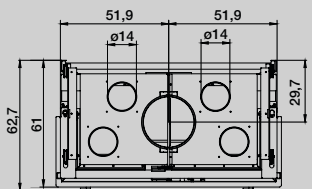
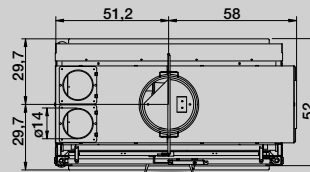
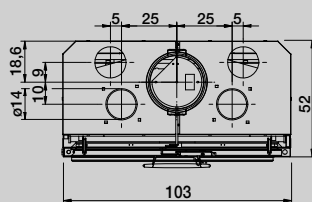
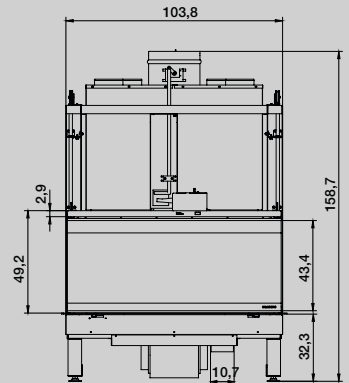
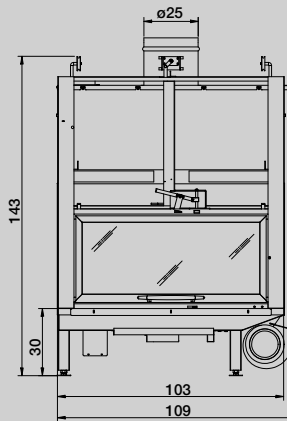
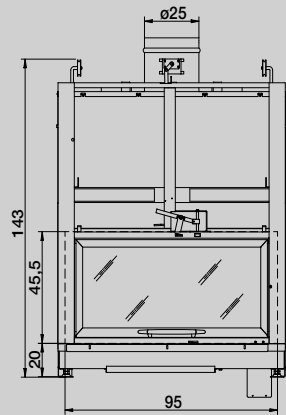



**ECOMBL S25:9**  
FRONTALE MAGNOFIX

frontal magnofix  
frontal magnofix  
frontal magnofix

**ECOMBL S25:9**  
BIFACCIALE MAGNOFIX

double-fronted magnofix  
double façade magnofix  
bifacial magnofix

Dimensioni/peso Dimensions/weight  
Dimensions/poids Dimensiones/peso

135x53x140h cm  
315 kg

135x55x152h cm  
305 kg

Potenza bruciata Heat input  
Puissance au foyer Potencia al hogar

kcal/h 22.700 - kW 26,4

kcal/h 23.200 - kW 27

Potenza globale (resa) Global heat output  
Puissance globale Potencia global

kcal/h 18.500 - kW 21,5

kcal/h 18.700 - kW 21,8

Rendimento Efficiency  
Rendement Rendimiento

~81,5%

~79,5%

Elettroventilatore OPTIONAL Room fan  
Électro-ventilateur Ventilador eléctrico

680 m³/h

680 m³/h

Uscita fumi Ø Exhaust outlet  
Sortie des fumées Salida de humos

25 cm\*

25 cm\*

Presa d'aria esterna External air intake  
Prise d'air extérieur Toma de aire exterior

Ø25 cm\*\*

Ø25 cm\*\*

FRONTALE FRONTAL  
FRONTAL FRONTAL

BIFACCIALE DOUBLE-FRONTED  
DOUBLE FAÇADE BIFACIAL

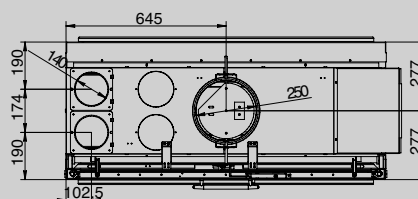
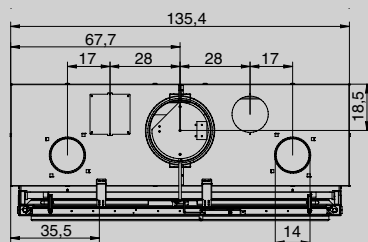
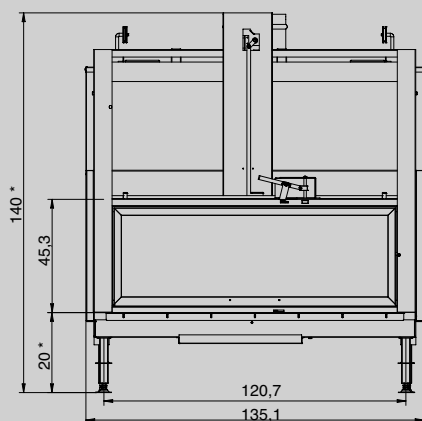





**ECOPALEX N64**  
FRONTALE

**ECOPALEX N64**  
DX/SX

**ECOPALEX N64**  
TONDO

	frontal frontal frontal	rh/lh d/g derecho/izquierdo	round arrondi redondo
Dimensioni/peso Dimensions/weight Dimensions/poids Dimensiones/peso	61x42x45h cm 100 kg	61x41x45h cm 100 kg	61x46x45h cm 100 kg
Potenza bruciata Heat input Puissance au foyer Potencia al hogar	kcal/h 9.500 - kW 11	kcal/h 9.500 - kW 11	kcal/h 9.500 - kW 11
Potenza globale (resa) Global heat output Puissance globale Potencia global	kcal/h 7.300 - kW 8,5	kcal/h 7.300 - kW 8,5	kcal/h 7.300 - kW 8,5
Rendimento Efficiency Rendement Rendimiento	~74,3%	~74,3%	~74,3%
Uscita fumi Ø Exhaust outlet Sortie des fumées Salida de humos	16 cm*	16 cm*	16 cm*
Presa d'aria esterna External air intake Prise d'air extérieur Toma de aire exterior	Ø15 cm**	Ø15 cm**	Ø15 cm**

FRONTALE FRONTAL  
FRONTAL FRONTAL

DX/SX RH/LH  
D/G DERECHO/IZQUIERDO

TONDO ROUND  
ARRONDI REDONDO

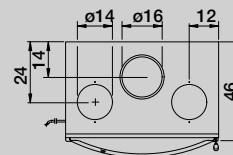
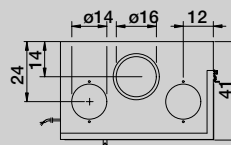
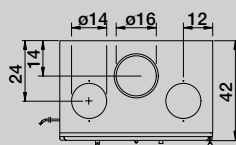
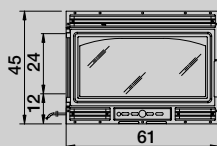

\*Approfondimento a pag. 66. \*More info on page 66. \*Approfondissement page 66. \*La profundización de la página 66.

\*\*In caso di canalizzazione della presa dell'aria, questa va aumentata di sezione (indicativamente 20% per ogni metro superiore al primo metro).

\*\*If the air intake is ducted, its cross-section must be increased (by approximately 20% for each metre bar the first one).

\*\* En cas de canalisation de la prise d'air, il faudra en augmenter la section (à titre indicatif, environ 20% pour chaque mètre au-delà du premier mètre).

\*\* En caso de canalización de la toma de aire, su sección se debe aumentar (un 20% aproximadamente por cada metro después del primero).



**ECOPALEX N66**  
FRONTALE

**ECOPALEX N70**  
RASTREMATO

**ECOPALEX N76**  
RASTREMATO

Dimensioni/peso Dimensions/weight  
Dimensions/poids Dimensiones/peso

61x42x50h cm  
100 kg

70x42x50h cm  
115 kg

75x45x56h cm  
129 kg

Potenza bruciata Heat input  
Puissance au foyer Potencia al hogar

kcal/h 10.600 - kW 12,4

kcal/h 12.400 - kW 14,4

kcal/h 13.500 - kW 15,7

Potenza globale (resa) Global heat output  
Puissance globale Potencia global

kcal/h 8.200 - kW 9,5

kcal/h 9.700 - kW 11,3

kcal/h 10.500 - kW 12,2

Rendimento Efficiency  
Rendement Rendimiento

~76,6%

~78,4%

~77,5%

Elettroventilatore OPTIONAL Room fan  
Électro-ventilateur Ventilador eléctrico

350 m<sup>3</sup>/h

680 m<sup>3</sup>/h

680 m<sup>3</sup>/h

Uscita fumi Ø Exhaust outlet  
Sortie des fumées Salida de humos

16 cm\*

16 cm\*

20 cm\*

Presa d'aria esterna External air intake  
Prise d'air extérieur Toma de aire exterior

Ø15 cm\*\*

Ø15 cm\*\*

Ø15 cm\*\*

FRONTALE FRONTAL  
FRONTAL FRONTAL

RASTREMATO TAPERED  
TRAPÈZE CHAFLÁN

RASTREMATO TAPERED  
TRAPÈZE CHAFLÁN

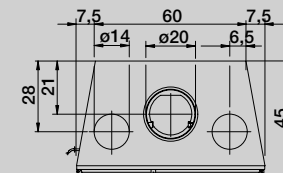
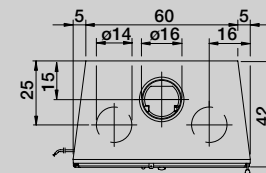
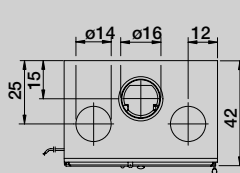
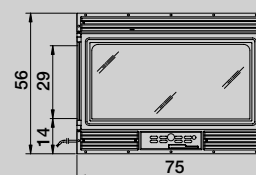
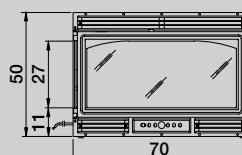
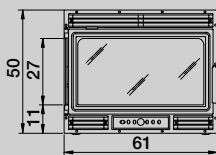



**ECOPALEX N76**  
FRONTALE

**ECOPALEX N76**  
DX/SX

**ECOPALEX N76**  
TONDO

	frontal frontal frontal	rh/lh d/g derecho/izquierdo	round arrondi redondo
Dimensioni/peso Dimensions/weight Dimensions/poids Dimensiones/peso	75x45x56h cm 139 kg	75x45x56h cm 134 kg	75x52x56h cm 139 kg
Potenza bruciata Heat input Puissance au foyer Potencia al hogar	kcal/h 13.500 - kW 15,7	kcal/h 13.500 - kW 15,7	kcal/h 13.500 - kW 15,7
Potenza globale (resa) Global heat output Puissance globale Potencia global	kcal/h 10.500 - kW 12,2	kcal/h 10.500 - kW 12,2	kcal/h 10.500 - kW 12,2
Rendimento Efficiency Rendement Rendimiento	~77,5%	~77,5%	~77,5%
Elettroventilatore OPTIONAL Room fan Électro-ventilateur Ventilador eléctrico	680 m <sup>3</sup> /h	680 m <sup>3</sup> /h	680 m <sup>3</sup> /h
Uscita fumi Ø Exhaust outlet Sortie des fumées Salida de humos	20 cm*	20 cm*	20 cm*
Presa d'aria esterna External air intake Prise d'air extérieur Toma de aire exterior	Ø15 cm**	Ø15 cm**	Ø15 cm**

FRONTALE  
FRONTAL  
FRONTAL  
FRONTAL

DX/SX  
RH/LH  
D/G  
DERECHO/IZQUIERDO

TONDO  
ROUND  
ARRONDI  
REDONDO

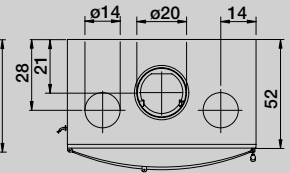
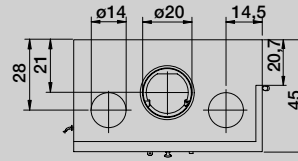
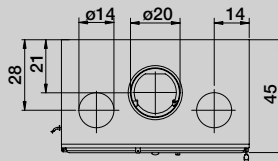
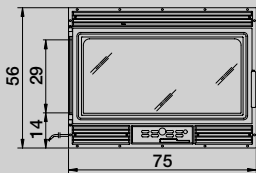

\*Approfondimento a pag. 66. \*More info on page 66. \*Approfondissement page 66. \*La profundización de la página 66.

\*\*In caso di canalizzazione della presa dell'aria, questa va aumentata di sezione (indicativamente 20% per ogni metro superiore al primo metro).

\*\*If the air intake is ducted, its cross-section must be increased (by approximately 20% for each metre bar the first one).

\*\* En cas de canalisation de la prise d'air, il faudra en augmenter la section (à titre indicatif, environ 20% pour chaque mètre au-delà du premier mètre).

\*\* En caso de canalización de la toma de aire, su sección se debe aumentar (un 20% aproximadamente por cada metro después del primero).



**ECOPALEX 78**  
FRONTALE

frontal  
frontal  
frontal

75x45x56h cm  
130 kg

Dimensioni/peso Dimensions/weight  
Dimensions/poids Dimensiones/peso

Potenza bruciata Heat input  
Puissance au foyer Potencia al hogar

kcal/h 13.500 - kW 15,7

Potenza globale (resa) Global heat output  
Puissance globale Potencia global

kcal/h 10.500 - kW 12,2

Rendimento Efficiency  
Rendement Rendimiento

~77,5%

Elettroventilatore OPTIONAL Room fan  
Électro-ventilateur Ventilador eléctrico

680 m³/h

Uscita fumi Ø Exhaust outlet  
Sortie des fumées Salida de humos

20 cm\*

Presa d'aria esterna External air intake  
Prise d'air extérieur Toma de aire exterior

Ø15 cm\*\*



**ECOPALEX 88**  
FRONTALE

frontal  
frontal  
frontal

88x53x62h cm  
185 kg

kcal/h 15.500 - kW 18

kcal/h 12.000 - kW 14

~77,7%

680 m³/h

20 cm\*

Ø15 cm\*\*

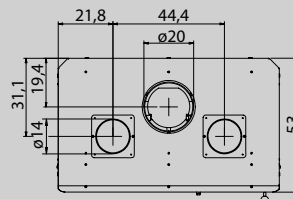
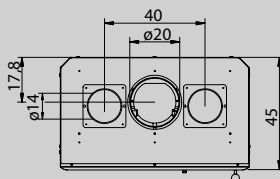
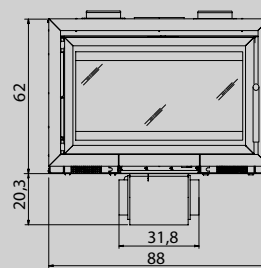
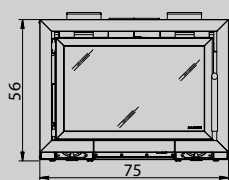



**ECOPALEX GLASS 66**  
FRONTALE

**ECOPALEX GLASS 70**  
RASTREMATO

**ECOPALEX GLASS 76**  
RASTREMATO

	frontal frontal frontal	tapered trapèze chaflán	tapered trapèze chaflán
Dimensioni/peso Dimensions/weight Dimensions/poids Dimensiones/peso	61x42x50h cm 100 kg	70x42x50h cm 115 kg	75x45x56h cm 129 kg
Potenza bruciata Heat input Puissance au foyer Potencia al hogar	kcal/h 10.600 - kW 12,4	kcal/h 12.400 - kW 14,4	kcal/h 13.500 - kW 15,7
Potenza globale (resa) Global heat output Puissance globale Potencia global	kcal/h 8.200 - kW 9,5	kcal/h 9.700 - kW 11,3	kcal/h 10.500 - kW 12,2
Rendimento Efficiency Rendement Rendimiento	~76,6%	~78,4%	~77,5%
Elettroventilatore OPTIONAL Room fan Électro-ventilateur Ventilador eléctrico	680 m <sup>3</sup> /h	680 m <sup>3</sup> /h	680 m <sup>3</sup> /h
Uscita fumi Ø Exhaust outlet Sortie des fumées Salida de humos	16 cm*	16 cm*	20 cm*
Presa d'aria esterna External air intake Prise d'air extérieur Toma de aire exterior	Ø15 cm**	Ø15 cm**	Ø15 cm**

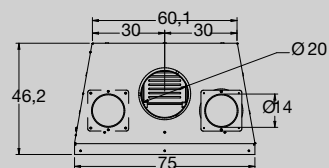
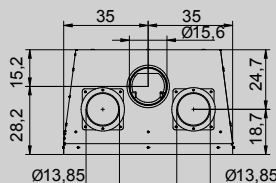
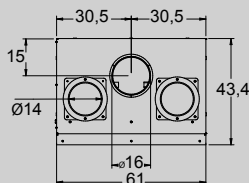
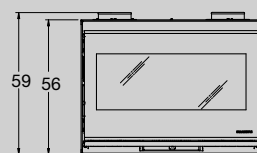
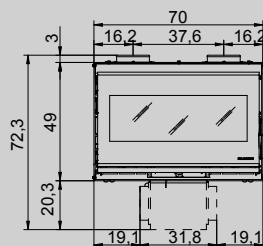
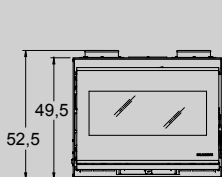

\*Approfondimento a pag. 66. \*More info on page 66. \*Approfondissement page 66. \*La profundización de la página 66.

\*\*In caso di canalizzazione della presa dell'aria, questa va aumentata di sezione (indicativamente 20% per ogni metro superiore al primo metro).

\*\*If the air intake is ducted, its cross-section must be increased (by approximately 20% for each metre bar the first one).

\*\* En cas de canalisation de la prise d'air, il faudra en augmenter la section (à titre indicatif, environ 20% pour chaque mètre au-delà du premier mètre).

\*\* En caso de canalización de la toma de aire, su sección se debe aumentar (un 20% aproximadamente por cada metro después del primero).



**ECOPALEX GLASS 88**  
FRONTALE

**INSERTO 45**  
PORTA PIANA

**INSERTO 45**  
PORTA TONDA

	frontal frontal frontal	flat door porte plate puerta plana	rounded door porte arrondie puerta redonda
Dimensioni/peso Dimensions/weight Dimensions/poids Dimensiones/peso	88x53x62h cm 185 kg	55x44x107h cm 150 kg	55x53x107h cm 150 kg
Potenza bruciata Heat input Puissance au foyer Potencia al hogar	kcal/h 15.500 - kW 18	kcal/h 11.200 - kW 13	kcal/h 11.200 - kW 13
Potenza globale (resa) Global heat output Puissance globale Potencia global	kcal/h 12.000 - kW 14	kcal/h 8.800 - kW 10,2	kcal/h 8.800 - kW 10,2
Rendimento Efficiency Rendement Rendimiento	~77,7%	~78,5%	~78,5%
Elettroventilatore OPTIONAL Room fan Électro-ventilateur Ventilador eléctrico	680 m³/h	680 m³/h	680 m³/h
Uscita fumi Ø Exhaust outlet Sortie des fumées Salida de humos	20 cm*	15 cm*	15 cm*
Presa d'aria esterna External air intake Prise d'air extérieur Toma de aire exterior	Ø15 cm**	Ø15 cm**	Ø15 cm**

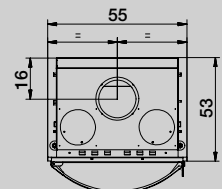
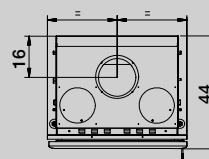
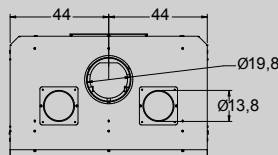
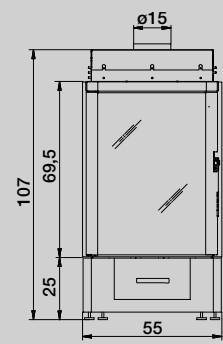
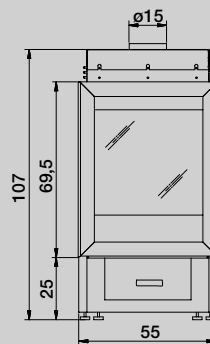
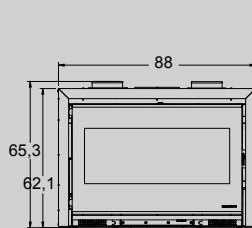



**H66 NEW**  
FRONTALE

**H76 NEW**  
FRONTALE

	frontal frontal frontal	frontal frontal frontal
Dimensioni/peso Dimensions/weight Dimensions/poids Dimensiones/peso	61x43x49h cm 100 kg	75x45x58h cm 139 kg
Potenza bruciata Heat input Puissance au foyer Potencia al hogar	kcal/h 10.600 - kw 12,4	kcal/h 13.500 - kw 15,7
Potenza globale (resa) Global heat output Puissance globale Potencia global	kcal/h 8.200 - kw 9,5	kcal/h 10.500 - kw 12,2
Rendimento Efficiency Rendement Rendimiento	~76,6%	~77,5%
Elettroventilatore OPTIONAL Room fan Électro-ventilateur Ventilador eléctrico	680 m³/h	680 m³/h
Uscita fumi Ø Exhaust outlet Sortie des fumées Salida de humos	16 cm*	20 cm*
Presa d'aria esterna External air intake Prise d'air extérieur Toma de aire exterior	Ø15 cm**	Ø15 cm**

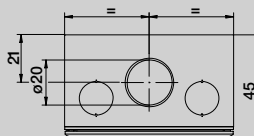
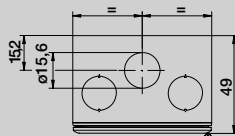
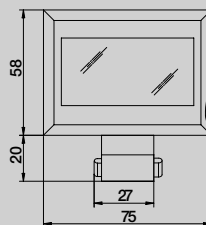
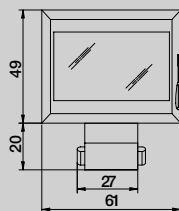

\*Approfondimento a pag. 66. \*More info on page 66. \*Approfondissement page 66. \*La profundización de la página 66.

\*\*In caso di canalizzazione della presa dell'aria, questa va aumentata di sezione (indicativamente 20% per ogni metro superiore al primo metro).

\*\*If the air intake is ducted, its cross-section must be increased (by approximately 20% for each metre bar the first one).

\*\* En cas de canalisation de la prise d'air, il faudra en augmenter la section (à titre indicatif, environ 20% pour chaque mètre au-delà du premier mètre).

\*\* En caso de canalización de la toma de aire, su sección se debe aumentar (un 20% aproximadamente por cada metro después del primero).



**IKI SQUARE  
FRONTALE**

**IKI UP  
FRONTALE**

**IKI 16:9  
FRONTALE**

	frontal frontal frontal	frontal frontal frontal	frontal frontal frontal
Dimensioni/peso Dimensions/weight Dimensions/poids Dimensiones/peso	67x54x67,5h cm 235 kg	60x54x128h cm 240 kg	114x54x66,5h cm 278 kg
Potenza bruciata Heat input Puissance au foyer Potencia al hogar	kcal/h 9.000 - kW 10,5	kcal/h 12.900 - kW 14,98	kcal/h 17.100 - kW 19,9
Potenza globale (resa) Global heat output Puissance globale Potencia global	kcal/h 7.300 - kW 8,5	kcal/h 10.300 - kW 12	kcal/h 13.400 - kW 15,58
Rendimento Efficiency Rendement Rendimiento	~81,3%	~80,2%	~78,2%
Uscita fumi Ø Exhaust outlet Sortie des fumées Salida de humos	18 cm*	18 cm*	18 cm*
Presa d'aria esterna External air intake Prise d'air extérieur Toma de aire exterior	Ø15 cm**	Ø15 cm**	Ø15 cm**

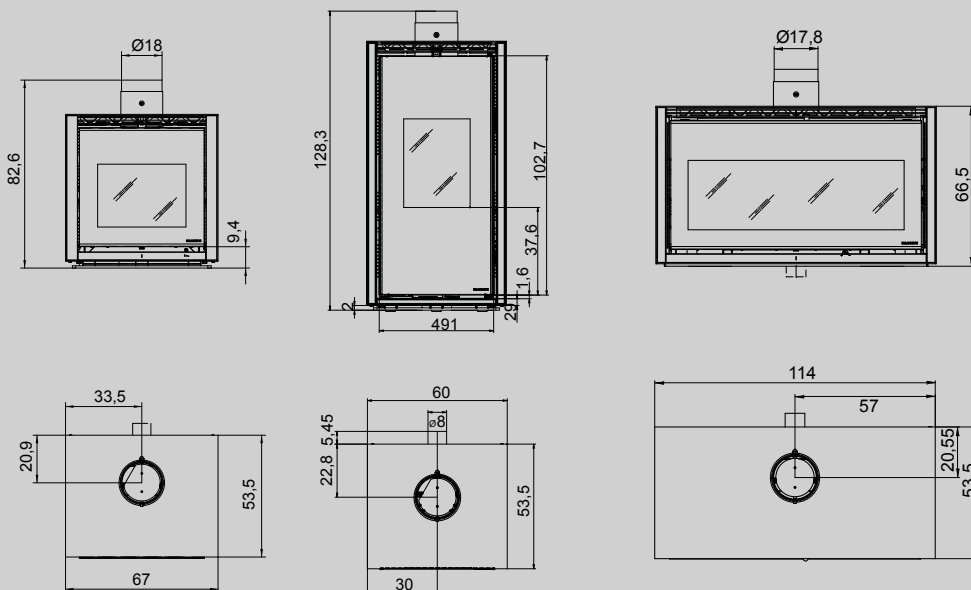

\*Approfondimento a pag. 66. \*More info on page 66. \*Approfondissement page 66. \*La profundización de la página 66.

\*\*In caso di canalizzazione della presa dell'aria, questa va aumentata di sezione (indicativamente 20% per ogni metro superiore al primo metro).

\*\*If the air intake is ducted, its cross-section must be increased (by approximately 20% for each metre bar the first one).

\*\* En cas de canalisation de la prise d'air, il faudra en augmenter la section (à titre indicatif, environ 20% pour chaque mètre au-delà du premier mètre).

\*\* En caso de canalización de la toma de aire, su sección se debe aumentar (un 20% aproximadamente por cada metro después del primero).





**MULTIFIRE 45**  
PORTA PIANA

**MULTIFIRE 45**  
PORTA TONDA

**MULTIFIRE**  
BIO 9

**MULTIFIRE**  
BIO 14

flat door  
porte plate  
puerta plana

rounded door  
porte arrondie  
puerta redonda

Dimensioni/peso Dimensions/weight Dimensions/poids Dimensiones/peso	82x60x177h cm 220 kg	82x71x177h cm 220 kg	98x56x116h cm 150 kg	
Potenza globale legna (resa) Heat input for wood Puissance globale bois Potencia global leña	kcal/h 14.300 - kW 16,6	kcal/h 14.300 - kW 16,6	kcal/h 9.047 kW 10,52	kcal/h 14.479 kW 14,51
Potenza globale pellet (resa) Heat input for pellet Puissance globale pellets Potencia global pellet	kcal/h 12.900 - kW 15	kcal/h 12.900 - kW 15	kcal/h 7.840 kW 9,12	kcal/h 14.470 kW 14,5
Rendimento legna Wood efficiency Rendement bois Rendimiento leña	~77%	~77%	~89,46%	~86,4%
Rendimento pellet Pellet efficiency Rendement pellets Rendimiento pellet	~84%	~84%	~90,1%	~90,19%
Quantità di combustibile consigliata kg/h Hourly fuel consumption Consommation combustible recommandée Cantidad aconsejada de combustible	legna wood bois leña 2,5~ ÷ 4,5~ pellet pellet pellets pellet max 3,7~ - min 1,2~	legna wood bois leña 2,5~ ÷ 4,5~ pellet pellet pellets pellet max 3,7~ - min 1,2~	legna wood bois leña 2,6 pellet pellet pellets pellet max 2,06~ ÷ min 0,76~	legna wood bois leña 2,6 pellet pellet pellets pellet max 3,28~ ÷ min 0,76~
Elettroventilatore di serie Room fan (fullyfitted) Électro-ventilateur (standard) Ventilador eléctrico (de serie)	680 m³/h	680 m³/h	570 m³/h	
Uscita fumi Ø Exhaust outlet Sortie des fumées Salida de humos	15 cm	15 cm	15 cm	
Presa d'aria esterna External air intake Prise d'air extérieur Toma de aire exterior	Ø15 cm**	Ø15 cm**	Ø8 cm**	Ø8 cm**

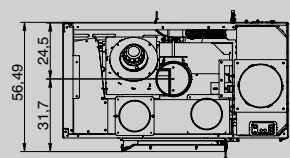
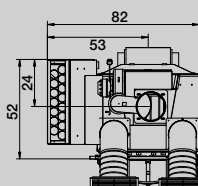
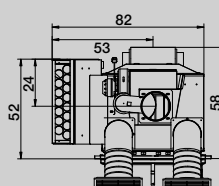
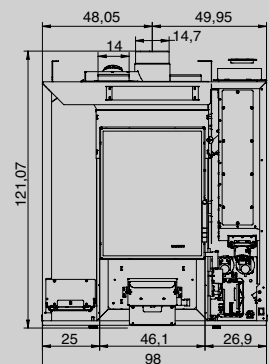
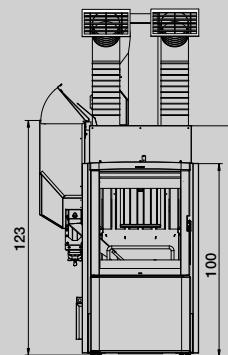
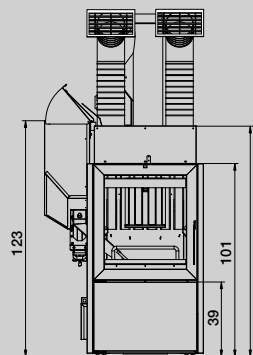



**ECOFIRE® DA INSERIM.  
CANALIZZABILE**

**ECOFIRE® DA INSERIM.  
VENTILAZIONE FRONTALE**

**ECOFIRE® SMALL 54  
VENTILAZIONE FRONTALE**

ductable air  
sortie d'air canalisable  
aria canalizable

front fan  
ventilation frontale  
ventilación frontal

front fan  
ventilation frontale  
ventilación frontal

Dimensioni/peso Dimensions/weight Dimensions/poids Dimensiones/peso	76x70x130h cm 160 kg	76x70x57h cm 150 kg	54x56x47h cm 100 kg
Potenza bruciata Heat input Puissance au foyer Potencia al hogar	kcal/h 11.610 - kW 13,5	kcal/h 11.610 - kW 13,5	kcal/h 5.900 - kW 6,9
Potenza globale (resa) Global heat output Puissance globale Potencia global	kcal/h 10.150 - kW 11,8	kcal/h 10.150 - kW 11,8	kcal/h 5.300 - kW 6,2
Autonomia di funzionamento (h) Max. operating autonomy (h) Autonomie de chauffe (h) Autonomía de funcionamiento (h)	26	25	35
Capacità serbatoio Fuel hopper capacity Capacité réservoir d'alimentation Capacidad depósito de alimentación	23 kg	23 kg	14 kg
Rendimento medio Average efficiency Rendement moyen Rendimiento medio	~89%	~89%	~91%
Elettroventilatore di serie Room fan (fullyfitted) Électro-ventilateur (standard) Ventilador eléctrico (de serie)	680 m³/h	270 m³/h	410 m³/h
Uscita fumi Ø Exhaust outlet Sortie des fumées Salida de humos	8 cm	8 cm	8 cm
Presa d'aria esterna External air intake Prise d'air extérieur Toma de aire exterior	Ø8 cm**	Ø8 cm**	Ø8 cm**

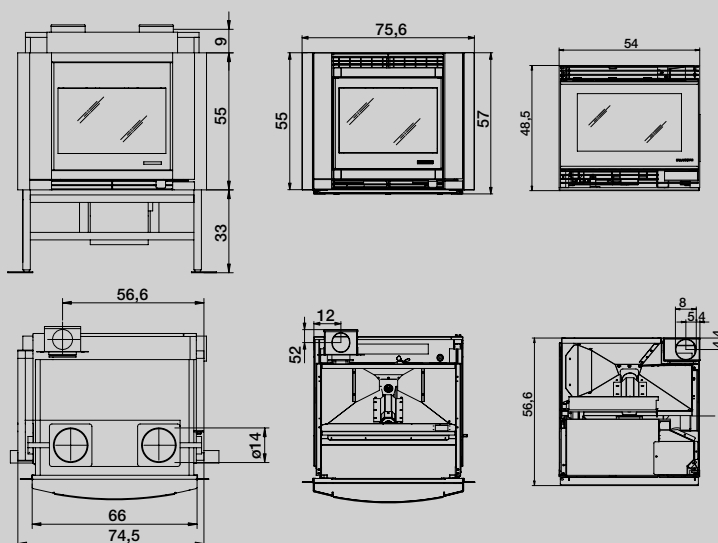

\*\*In caso di canalizzazione della presa dell'aria, questa va aumentata di sezione (indicativamente 20% per ogni metro superiore al primo metro).

\*\*If the air intake is ducted, its cross-section must be increased (by approximately 20% for each metre bar the first one).

\*\* En cas de canalisation de la prise d'air, il faudra en augmenter la section (à titre indicatif, environ 20% pour chaque mètre au-delà du premier mètre).

\*\* En caso de canalización de la toma de aire, su sección se debe aumentar (un 20% aproximadamente por cada metro después del primero).



**ECOFIRE®**  
DA RIVESTIMENTO 9

for cladding  
pour habillage  
para revestimiento

45x49x115h cm  
120 kg

kcal/h 8.600 - kW 10

kcal/h 7.740 - kW 9

42

27 kg

~91%

370 m³/h

8 cm

Ø8 cm\*\*



**ECOFIRE®**  
DA RIVESTIMENTO 12

for cladding  
pour habillage  
para revestimiento

66x57x114h cm  
120 kg

kcal/h 11.400 - kW 13,3

kcal/h 10.500 - kW 12,2

28

25 kg

~91,4%

2 x 140 m³/h

8 cm

Ø8 cm\*\*

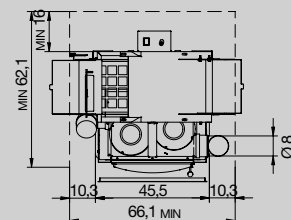
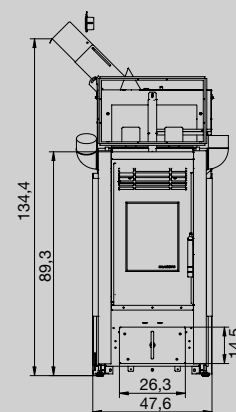
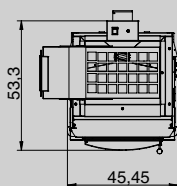
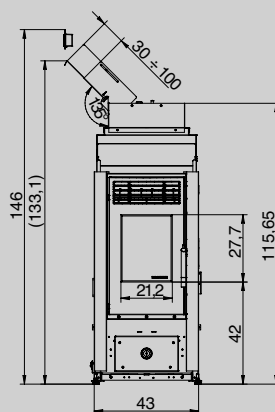

# DIMENSIONAMENTO DELLA CANNA FUMARIA

## FLUE SIZING. DIMENSIONS DU CONDUIT DE FUMÉE. DIMENSIONADO DEL CAÑÓN DE HUMO.

\*Il corretto dimensionamento del sistema di evacuazione dei fumi deve rispondere alla norma europea (EN13384-1) che indica la procedura di calcolo tenendo in considerazione i parametri relativi alla posizione fisica della installazione (altitudine, temperatura esterna, altezza della canna fumaria, numero di curve) e alle caratteristiche del prodotto che verrà allacciato (potenza, temperatura fumi, massa fumi).

\* The correct flue size must comply with the EN13384-1 European standard which explains how to make calculations, taking into account certain parameters such as the physical position of the installation (altitude, outdoor temperature, height of the flue, number of bends) and the specifications of the firebox that will be used (heat output, flue gas temperature, flue gas mass flow).

\*La dimension correcte du système d'évacuation des fumées doit répondre à la norme européenne (EN13384-1) qui indique la procédure de calcul en tenant compte des paramètres relatifs à la position géographique de l'installation et à sa forme (altitude, température extérieure, hauteur du conduit de fumées, nombres de coudes) et des caractéristiques de l'appareil que l'on devra brancher (puissance, température des fumées, masse volumique des fumées).

\*El dimensionado correcto del sistema de evacuación de los humos debe cumplir la norma europea (EN13384-1) que reglamenta el proceso de cómputo teniendo en cuenta los parámetros correspondientes a la ubicación de la instalación (altitud, temperatura externa, altura del cañón, número de codos) y a las características del producto que se va a instalar (potencia, temperatura de humos, masa de humos).

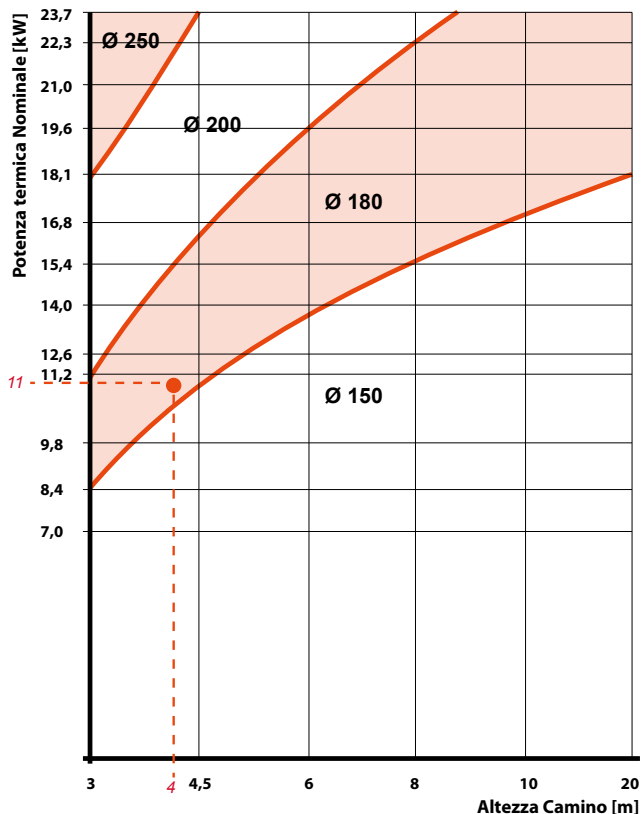

**Esempio:** Focolare da 11 kW: Altezza canna fumaria ~ 4 m e diametro minimo Ø 180 mm. È comunque importante non realizzare canne fumarie con sezione inferiore al diametro di uscita fumi del prodotto e altezza minima di 3,5 m.

Example: 11 kW firebox: Flue length ~ 4 m, minimum diameter Ø 180 mm. The diameter of the flue's cross-section must never be smaller than the product's flue gas outlet diameter and it must be at least 3.5 metres long.

Exemple : Foyer de 11 kW : Hauteur conduit de fumée ~ 4 m et diamètre minimum Ø 180 mm. Il est important de ne pas réaliser de conduit de fumée avec une section inférieure au diamètre de sortie des fumées du produit et tel conduit devra avoir une hauteur minimum de 3,5 m.

Ejemplo: Hogar de 11 kW: Altura del cañón ~ 4 m y diámetro mínimo Ø 180 mm. Sin embargo es importante no realizar cañones con sección inferior al diámetro de la salida de humos del producto y altura mínima de 3,5 m.

Il diagramma ha carattere puramente indicativo e consente, in funzione della potenza termica del focolare (in kW) di individuare una altezza [m] e il diametro utile [mm]. È comunque sempre obbligatorio effettuare il dimensionamento in conformità alla norma EN 13384-1.

This graph is purely indicative. Its purpose is to help identify the length (m) and useable diameter (mm) of the flue based on the heat output of the firebox. Flue sizing must always comply with the EN 13384-1 standards.

Le diagramme est fourni à titre purement indicatif et permet, en fonction de la puissance calorifique du foyer (en kW), de trouver la hauteur [m] et le diamètre utile [mm]. Il est dans tous les cas obligatoire d'effectuer le dimensionnement du conduit conformément à la norme EN 13384-1.

El diagrama tiene carácter meramente indicativo y permite determinar la altura [m] y el diámetro útil [mm], en función de la potencia térmica del hogar (en kW). Es obligatorio realizar siempre el dimensionado conforme a la norma EN 13384-1.

# ACCESSORI

## ACCESSORIES. ACCESSOIRES. ACCESORIOS.



### *Kit scintilla*

Dispositivo di accensione automatica dei Monoblocchi predisposti. L'accensione può avvenire a mezzo interruttore gestito o meno da timer (non incluso), oppure via telefono tramite un attuatore optional (GSM control).

#### **Kit scintilla**

This device permits automatic ignition of selected fireboxes in the Ecomonoblocco range. Ignition can take place by means of a switch that can be governed by a timer (not included), or by phone via GSM by means of an optional actuator.

#### **Kit scintilla**

Dispositif permettant l'allumage automatique des Monoblocs qui sont prévus à cet effet. L'allumage peut s'effectuer à l'aide d'un interrupteur géré ou non par un temporisateur (non compris) ou bien par téléphone à l'aide d'un actionneur optionnel (GSM control).

#### **Kit scintilla**

Dispositivo que permite el encendido automático de los Monobloccos predisuestos. El encendido puede realizarse mediante el interruptor controlado o menos por el temporizador (no incluido), o por teléfono mediante un actuador opcional (GSM control).



### *Kit cottura con supporto griglia*

Con telaio acciaio e area cottura in acciaio inox, manici in legno. Oppure in acciaio inox con supporto in acciaio.

#### **Grill kit with support**

With steel frame and stainless steel grill, wooden handles. Alternatively, in stainless steel with steel support.

#### **Kit cuisson avec support grille**

Avec structure en acier et zone de cuisson en acier inox, poignées en bois. Ou bien en acier inox avec support en acier.

#### **Kit cocción con soporte parrilla**

Con estructura de acero, zona de cocción de acero inox y asas de madera. O en acero inox con soporte de acero.



### *Kit cottura con supporto bioplatt*

Grande piano di pietra ollare con riquadro in acciaio con piedini di supporto.

**Bioplatt broiling slab with support** It is a large slab of soapstone with a steel frame and support.

**Kit cuisson bioplatt avec support** Il s'agit d'un grand plan de cuisson en pierre ollaire avec cadre en acier et pieds de support.

**Kit cocción con soporte bioplatt** Es de piedra ollar enmarcada en acero y con patas metálicas de soporte.



### *Connection box*

Connection box consente di gestire i focolari a pellet tramite smartphone con la APP Palazzetti. (di serie su alcuni modelli per info [www.palazzetti.it](http://www.palazzetti.it))

The connection box allows you to control the pellet fireboxes from your smartphone using the Palazzetti APP. (supplied standard with some models; for info please visit [www.palazzetti.it](http://www.palazzetti.it))

La Connection box permet de contrôler les foyers à pellets depuis un smartphone via l'APP Palazzetti. (en standard sur certains modèles. Pour info [www.palazzetti.it](http://www.palazzetti.it))

Connection box permite controlar los hogares de pellets mediante smartphone con la APP Palazzetti (de serie para algunos modelos, para más información [www.palazzetti.it](http://www.palazzetti.it)).



### *Girarrosti*

Girarrosto motorizzato con 4 aste e leccarda in acciaio inox disponibile in due dimensioni.

**Spits** Motor-driven spit with 4 rods and stainless steel drip pan available in two sizes.

**Tournebroches** Tournebroche motorisé avec 4 broches et lèchefrite en acier inox, disponible en deux dimensions.

**Asadores** Asador motorizado con 4 espetones y grasera de acero inox disponible en dos tamaños.



### *Nerone*

Bidone aspiracenere indicato per caminetti e stufe.

Ash vacuum cleaner suitable for fireplaces and stoves. Minimum order of 6 pieces.

Aspirateur à cendres indiqué pour cheminées et poêles. Commande minimum de 6 pièces.

Aspiradora de ceniza apta para chimeneas y estufas. Pedido mínimo de 6 unidades.

# CERTIFICAZIONI

## CERTIFICATIONS. CERTIFICATIONS. CERTIFICACIONES.

Tutti i nostri prodotti sono testati e certificati secondo le più severe normative internazionali. **L'esposizione del marchio e del numero di certificazione** garantisce che il prodotto acquistato sia stato controllato e omologato in conformità agli standard qualitativi più rigorosi.

All our products are tested and certified according to the strictest international regulations. **By displaying the label and the certificate number** we guarantee that the product purchased has been checked and approved in compliance with the most rigorous quality standards.

Tous nos produits ont été testés et certifiés selon les normes internationales les plus sévères. **Le label et le numéro de certification** apposés sur le produit que vous avez acheté assure qu'il a été contrôlé et homologué conformément aux standards de qualité les plus stricts.

Todos nuestros productos son probados y certificados conforme a las más rígidas normativas internacionales. **La exposición de la marca y del número de certificado** garantiza que el producto adquirido ha sido controlado y homologado conforme a los más rigurosos estándares de calidad.



Prodotto - Product Produit - Producto	Istituto - Institution Institut - Instituto	Test Report	Norma - Standard Norme - Norma
Ecomonoblocco 45 Frontale Frontal Frontal Frontal	TÜV RHEINLAND	K186 2006 T1	EN 13229
Ecomonoblocco 45 Tondo Round Arrondi Redondo	TÜV Rheinland	K186 2006 T1	EN 13229
Ecomonoblocco 45 Bifacciale Double-fronted Double façade Bifacial	ACTECO	3055-07 NB	EN 13229
Ecomonoblocco 64 Frontale Frontal Frontal Frontal	KIWA ITALIA	400528	EN 13229
Ecomonoblocco 64 Dx/Sx Rh/Lh D/G Derecho/Izquierdo	KIWA ITALIA	400528	EN 13229
Ecomonoblocco 64 Exagone Exagone Exagone Exagone	KIWA ITALIA	400528	EN 13229
Ecomonoblocco Em 64 Frontale Frontal Frontal Frontal	ACTECO	2271-07 NB	EN 13229
Ecomonoblocco 64 V08 Dx/Sx Rh/Lh D/G Derecho/Izquierdo	ACTECO	2271-07 NB	EN 13229
Ecomonoblocco 64 V08 Exagone Exagone Exagone Exagone	ACTECO	2271-07 NB	EN 13229
Ecomonoblocco Em 66 Frontale Frontal Frontal Frontal	ACTECO	1578-07 NB	EN 13229
Ecomonoblocco Em 66 Frontale Frontal Frontal Frontal	KIWA ITALIA	400300-66	EN 13229
Ecomonoblocco 66 V08 Exagone Exagone Exagone Exagone	ACTECO	1578-07 NB	EN 13229
Ecomonoblocco 66 V08-S Exagone Exagone Exagone Exagone	KIWA ITALIA	400300-66	EN 13229
Ecomonoblocco 66 V08 Tondo Round Arrondi Redondo	ACTECO	1578-07 NB	EN 13229
Ecomonoblocco 66 V08-S Tondo Round Arrondi Redondo	KIWA ITALIA	400300-66	EN 13229
Ecomonoblocco 66 Tondo 180° Round 180° Arrondi 180° Redondo 180°	KIWA ITALIA	400300-66	EN 13229
Ecomonoblocco S66 Frontale 3D Frontal 3D Frontal 3D Frontal 3D	TÜV RHEINLAND	K6642011T1	EN 13229
Ecomonoblocco 66 Bifacciale Tondo Double-fronted round Double façade arrondi Bifacial redondo	KIWA ITALIA	400300-66	EN 13229
Ecomonoblocco 78 Frontale Frontal Frontal Frontal	ACTECO	3610-08 NB	EN 13229
Ecomonoblocco Em 78 Frontale Frontal Frontal Frontal	KIWA ITALIA	400516	EN 13229
Ecomonoblocco Em 78 Frontale Frontal Frontal Frontal	KIWA ITALIA	400300-78	EN 13229
Ecomonoblocco 78 Dx/Sx Rh/Lh D/G Derecho/Izquierdo	ACTECO	3610-08 NB	EN 13229
Ecomonoblocco 78 V08 Dx/Sx Rh/Lh D/G Derecho/Izquierdo	KIWA ITALIA	400516	EN 13229
Ecomonoblocco 78 V08-S Dx/Sx Rh/Lh D/G Derecho/Izquierdo	KIWA ITALIA	400300-78	EN 13229
Ecomonoblocco 78 Exagone Exagone Exagone Exagone	ACTECO	3610-08 NB	EN 13229

Prodotto - Product Produit - Producto	Istituto - Institution Institut - Instituto	Test Report	Norma - Standard Norme - Norma
Ecomonoblocco 78 V08 Exagone Exagone Exagone Exagone	KIWA ITALIA	400516	EN 13229
Ecomonoblocco 78 V08-S Exagone Exagone Exagone Exagone	KIWA ITALIA	400300-78	EN 13229
Ecomonoblocco S78 3D Frontale Frontal Frontal Frontal	KIWA ITALIA	100201206	EN 13229
Ecomonoblocco Em 78 Bifacciale Double-fronted Double façade Bifacial	KIWA ITALIA	400300-78	EN 13229
Ecomonoblocco 86 Frontale Frontal Frontal Frontal	KIWA ITALIA	400569	EN 13229
Ecomonoblocco Em 86 Frontale Frontal Frontal Frontal	ACTECO	1580-07 NB	EN 13229
Ecomonoblocco Em 86 Frontale Frontal Frontal Frontal	KIWA ITALIA	400469	EN 13229
Ecomonoblocco 86 Dx/Sx Rh/Lh D/G Derecho/Izquierdo	KIWA ITALIA	400569	EN 13229
Ecomonoblocco 86 V08 Dx/Sx Rh/Lh D/G Derecho/Izquierdo	ACTECO	1580-07 NB	EN 13229
Ecomonoblocco 86 V08-S Dx/Sx Rh/Lh D/G Derecho/Izquierdo	KIWA ITALIA	400469	EN 13229
Ecomonoblocco Em 16:9 Frontale Frontal Frontal Frontal	ACTECO	1636-07 NB	EN 13229
Ecomonoblocco Em 16:9 Bifacciale Double-fronted Double façade Bifacial	KIWA ITALIA	101100925	EN 13229
Ecomonoblocco S25:9 Frontale Frontal Frontal Frontal	KIWA ITALIA	400470	EN 13229
Ecomonoblocco S25:9 Bifacciale Double-fronted Double façade Bifacial	KIWA ITALIA	400470	EN 13229
Ecomonoblocco 16:9 3D	TÜV RHEINLAND	K16762015Z1	EN 13229
Ecopalex N64 Frontale Frontal Frontal Frontal	ACTECO	1576-07 NB	EN 13229
Ecopalex N64 Dx/Sx Rh/Lh D/G Derecho/Izquierdo	ACTECO	1576-07 NB	EN 13229
Ecopalex N64 Tondo Round Arrondi Redondo	ACTECO	1576-07 NB	EN 13229
Ecopalex N66/Glass 66 Frontale Frontal Frontal Frontal	ACTECO	1575-07 NB	EN 13229
Ecopalex N70/Glass 70 Rastremato Tapered Trapèze Chaflán	ACTECO	1574-07 NB	EN 13229
Ecopalex N76/Glass 76 Rastremato Tapered Trapèze Chaflán	ACTECO	1566-07NB	EN 13229
Ecopalex N76 Frontale Frontal Frontal Frontal	ACTECO	1566-07NB	EN 13229
Ecopalex N76 Dx/Sx Rh/Lh D/G Derecho/Izquierdo	ACTECO	1566-07NB	EN 13229
Ecopalex N76 Tondo Round Arrondi Redondo	ACTECO	1566-07NB	EN 13229
Ecopalex 78 Frontale Frontal Frontal Frontal	ACTECO	1566-07NB	EN 13229
Ecopalex 88/Glass 88 Frontale Frontal Frontal Frontal	ACTECO	1577-07 NB	EN 13229
Inserto 45 Aria Porta Piana Flat door Porte plate Puerta plana	TÜV RHEINLAND	K185 2007 T8	EN 13229
Inserto 45 Aria Porta Tonda Rounded door Porte arrondie Puerta redonda	TÜV RHEINLAND	K185 2007 T8	EN 13229
Inserto H66 New	ACTECO	1575-07 NB	EN 13229
Inserto H76 New	ACTECO	1566-07 NB	EN 13229
Iki 16:9	TÜV RHEINLAND	K15312015Z1	EN 13240
Iki Square	TÜV RHEINLAND	K16752015Z1	EN 13240
Iki Up	TÜV RHEINLAND	K16772015Z1	EN 13240
Multifire 45 Aria Porta Piana Flat door Porte plate Puerta plana	KIWA ITALIA	400196	EN 13229 - EN 14785
Multifire 45 Aria Porta Tonda Rounded door Porte arrondie Puerta redonda	KIWA ITALIA	400196	EN 13229 - EN 14785
Multifire Bio 9 Aria	TÜV RHEINLAND	K9122012T1	EN 13229 - EN 14785
Multifire Bio 14 Aria	TÜV RHEINLAND	K9122012T1	EN 13229 - EN 14785
Ecofire da Inserimento Canalizzabile Ductable air Sortie d'air canalisable Aria canalizable	TÜV RHEINLAND	K1102011	EN 14785
Ecofire da Inserimento Ventilazione Frontale Front fan Ventilation frontale Ventilación frontal	TÜV RHEINLAND	K1102011	EN 14785
Ecofire da Inserimento Small 54	TÜV RHEINLAND	K8192012Z1	EN 14785
Ecofire da Rivestimento 9,3 Kw	TÜV RHEINLAND	K7262012Z1	EN 14785
Ecofire da Rivestimento 12,2 Kw Canalizzabile Ductable air Sortie d'air canalisable Aria canalizable	TÜV RHEINLAND	K5242010Z1	EN 14785

La casa costruttrice non si assume responsabilità per eventuali errori o inesattezze nel contenuto di questo catalogo e si riserva il diritto di apportare ai suoi prodotti, in qualunque momento e senza preavviso, eventuali modifiche ritenute opportune per qualsiasi esigenza di carattere tecnico o commerciale.

The manufacturer is not responsible for any errors or inaccuracies contained in this price list and is entitled to make any modifications to its products deemed necessary for technical or commercial reasons at any time and without giving prior notice.

Le fabricant décline toute responsabilité quant aux erreurs ou inexactitudes éventuelles contenues dans le présent catalogue et se réserve le droit d'apporter, à tout moment et sans aucun préavis, toutes les modifications qu'il jugera nécessaires en vue de satisfaire les exigences techniques ou commerciales.

El Fabricante no se responsabiliza de los errores o imprecisiones eventuales de este catálogo y se reserva el derecho de aportar a sus productos, en cualquier momento y sin previo aviso, las modificaciones que opine oportunas para cualquier exigencia técnica o comercial.

# PALAZZETTI

IL CALORE CHE PIACE ALLA NATURA

Palazzetti Lelio S.p.a.  
Via Roveredo, 103  
33080 Porcia (PN) Italia  
Tel. +39 0434 922922

internet: [www.palazzetti.it](http://www.palazzetti.it)  
social: [palazzettigroup](#)



 **palazzettiweb**

