



BEETHOVEN

EQB DESIGN



TABELLA PREZZI FINITURE	pag. 168
INFO TECNICHE	pag. 168
INDICE / INDEX	pag. 170
LAVABO	pag. 173
BIDET	pag. 175
DOCCIA INCASSO	pag. 175
DEVIATORI INCASSO	pag. 176
DOCCIA ESTERNO	pag. 176
VASCA	pag. 177
BAGNO COMPLEMENTI	pag. 179



BEETHOVEN

PREZZO FINITURE

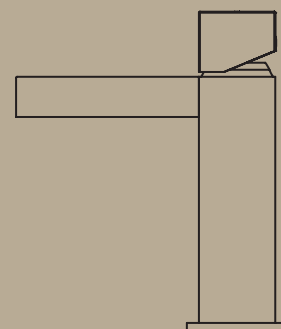
Calcola il prezzo di listino (IVA esclusa) delle finiture diverse dal cromato, consultando la seguente tabella.

Moltiplicare il **PREZZO LISTINO** per il **COEFFICIENTE MOLTIPLICATORE** della finitura scelta, arrotondando per difetto il prezzo ottenuto (eliminare i centesimi).
ESEMPIO per ordinare art. 7705/7/S in finitura dorato: codice **04-7705/7/S**

PRICE FINISHES

Include the list price (excluding VAT) of different finishes from chrome, consulting the following table. **Multiply the PRICE LIST MULTIPLIER COEFFICIENT** of the chosen finish, **reducing the price obtained by deleting the centesim.**

EXAMPLE to order art. 7705/7/S gold finish: code **04-7705/7/S**

FINITURE DI SERIE / STANDARD FINISHES

CODICE CODE	DESCRIZIONE FINITURA FINISH DESCRIPTION	MOLTIPLICATORE MULTIPLIER
01-	cromato / chrome	PREZZO LISTINO°

FINITURE A RICHIESTA / ON REQUEST FINISHES

CODICE CODE	DESCRIZIONE FINITURA FINISH DESCRIPTION	MOLTIPLICATORE MULTIPLIER
02-	cromo/oro / chrome/gold	x
03-	oro/argento / gold/silver	x
04-	dorato / gold	x
05-	bronzo satinato / satin bronze	x
06-	rame vecchio / old copper	x
07-	vecchio argento / old silver	NON REALIZZABILE*
08-	canna di fucile / gun barrel	NON REALIZZABILE*
10-	verderame / verdigris	NON REALIZZABILE*
11-	nero antracite / anthracite black	NON REALIZZABILE*
12-	ottone lucido / polished brass	NON REALIZZABILE*
13-	ottone naturale / natural brass	x
14-	bianco / white	NON REALIZZABILE*
19-	nero / black	NON REALIZZABILE*
28-	nickel satinato / satin nickel	x
30-	nickel lucido / polished nickel	NON REALIZZABILE*

COMPOSIZIONE CODICE PER ORDINARE ARTICOLO IN FINITURA



CODICE FINITURA
FINISH CODE

CODICE ARTICOLO
ITEM NUMBER

FINITURE A RICHIESTA / ON REQUEST FINISHES

CODICE CODE	DESCRIZIONE FINITURA FINISH DESCRIPTION	MOLTIPLICATORE MULTIPLIER
33-	cromo satinato / satin chrome	x
34-	cromo spazzolato / brushing chrome	x
35-	nickel spazzolato / brushing nickel	x
56-	avorio / ivory	NON REALIZZABILE*
57-	azzurro / light blue	NON REALIZZABILE*
58-	verdino / light green	NON REALIZZABILE*
59-	marrone / brown	NON REALIZZABILE*
60-	arancio / orange	NON REALIZZABILE*
61-	rosso / red	NON REALIZZABILE*
66-	bianco opaco / mat white	x
67-	nero opaco / mat black	x
68-	rame opaco / mat copper	x
69-	argento opaco / mat silver	x
71-	oro opaco / mat gold	NON REALIZZABILE*
72-	bronzo opaco / mat bronze	NON REALIZZABILE*
75-	dorato spazzolato / brushing gold	NON REALIZZABILE*
87-	oro rosa / pink gold	x
88-	ottone sisal / sisal brass	x

*PREZZO DI LISTINO / PRICE LIST

*NON REALIZZABILE / NOT MADE

ATTENZIONE! 13-OTTONE NATURALE e 88-OTTONE SISAL: finiture non protette che antichizzano naturalmente ossidando a contatto con l'umidità atmosferica.
WARNING! 13-NATURAL BRASS and 88-SISAL BRASS: unprotected finishes that naturally oxidise in contact with atmospheric humidity.

PROGETTO SU MISURA: RICHIESTE SPECIALI

I tecnici di Bellosta Rubinetterie sono, inoltre, a disposizione di architetti e designers, per offrire un servizio esclusivo: personalizzazioni di elementi in funzione di specifiche richieste estetiche o problematiche legate a vincoli progettuali, verifica della fattibilità attraverso opportuni studi CAD e sviluppo del disegno tecnico del prodotto speciale richiesto.

Per informazioni e richieste PROGETTI SU MISURA:
 ufficiotecnico@bellostarubinetterie.com



PROGETTO SU MISURA: SPECIAL REQUESTS

Engineers Bellosta Rubinetterie are also available to architects and designers, to offer an exclusive service: customizations of items according to specific aesthetic requirements or issues related to design constraints, verification of the feasibility studies and development through appropriate CAD technical design the required special product. For information and requests "SU MISURA" PROJECTS:
 ufficiotecnico@bellostarubinetterie.com



CONSIGLIO TECNICO

Tutti i miscelatori della collezione BEETHOVEN vengono collaudati nel loro funzionamento al momento dell'assemblaggio. Per garantire la durata delle cartucce nel tempo, si consiglia di spurgare bene l'impianto idraulico prima del montaggio (per rimuovere eventuali detriti) e di installare rubinetti sottolavabo con filtro (art. 7720)

N.B.: Qualora il piano lavabo avesse uno spessore superiore a 5 cm specificare la misura al momento dell'ordine.

TECHNICAL ADVICE

All mixers of the BEETHOVEN collection are perfectly tested. To guarantee the perfect functionality of the cartridge for a long time, we advise to clean the sanitary plant before installing the mixer. Moreover we advise to install angle valve with filter (art. 7720).

Attention: If the lavatory top is more than cm 5 thick, please point it out when placing the order.



FORATURA DEI PIANI SANITARI

I miscelatori lavabo/bidet monoforo prevedono un foro di diametro 35 mm nel piano sanitario.

MONOFORO >>

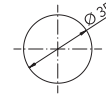

DRILLING PLANS HEALTH

The sink / hole bidet mixers provide a hole diameter of 35 mm in the health plan.

SCHEMA FUNZIONAMENTO DEVIATORI INCASSO 2/3/4 USCITE

Questi deviatori non hanno funzione di chiusura. Ruotando verso destra o sinistra si attivano le uscite. Tra 2 uscite adiacenti durante la rotazione diminuisce la portata dell'uscita iniziale ed incrementa quella della successiva. In posizione intermedia sono entrambe attive a pari portata.

SCHEME OPERATION SWITCHES FLUSH OUTPUT 2/3/4

These diverters have not closing function. By turning to the right or left activates the outputs. Between two adjacent outputs during the rotation decreases the initial output flow and increases that of the next. In position intermediate are both active at the same flow rate.



2 OUT

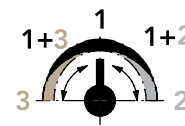

3 OUT

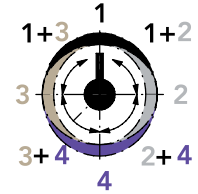

4 OUT

LEGENDA SIMBOLI

**ACCESSORI
ACCESSORIES**



SCARICO C/TAPPO
A PRESSIONE

WASTE WITH
PRESSURE CAP

**RICAMBI IMMEDIATI
IMMEDIATE PARTS**



CARTUCCIA
CARTRIDGE



CARTUCCIA DEVIATRICE
DIVERTER CARTRIDGE



CARTUCCIA TERMOSTATICA
THERMOSTATIC CARTRIDGE



DEVIATORE
DIVERTER



VITONE CERAMICO
CERAMIC VALVE



VITONE TRADIZIONALE
TRADITIONAL VALVE



BEETHOVEN

LAVABO



7705/7/S pag. 173

MISCELATORE LAVABO/BIDET MONOFORO
BASIN/BIDET MIXER



7705/P/S pag. 173

MISCELATORE LAVABO MONOFORO BOCCA
PROLUNGATA
BASIN MIXER EXTENDED SPOUT



774001, 774002, 774003 pag. 173

PROLUNGHE MISCELATORE LAVABO
EXTENSIONS BASIN MIXER

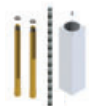

altezza mm 50 / high 50 mm: 774001
altezza mm 100 / high 100 mm: 774002
altezza mm 150 / high 150 mm: 774003



7705/3/E + 774057 pag. 173

MISCELATORE LAVABO DA PARETE
WALL BASIN MIXER



parti esterne / external parts: 7705/3/E
parte incasso / built-in part: 774057



7705/3/A/E + 884069 pag. 173

MISCELATORE LAVABO DA PARETE SU PIASTRA
WALL BASIN MIXER ON PLATE



parti esterne / external parts: 7705/3/A/E
parte incasso / built-in part: 884069



7705/PST/E + 734012 pag. 174

MISCELATORE LAVABO C/ATTACCHI A PAVIMENTO
FLOOR BASIN MIXER



parti esterne / external parts: 7705/PST/E
parte incasso / built-in part: 734012



7705/R/A pag. 174

MISCELATORE REMOTO
REMOTE MIXER



7705/R/B/E + 104033 pag. 174

MISCELATORE INCASSO REMOTO
BUILT-IN REMOTE MIXER



parti esterne / external parts: 7705/R/B/E
parte incasso / built-in part: 104033



7705/1/A pag. 174

BOCCA LAVABO MONOFORO
WASH SPOUT



7705/1/B pag. 174

BOCCA LAVABO MONOFORO MEDIUM
"MEDIUM SIZE" WASH SPOUT



7705/1/C pag. 175

BOCCA LAVABO MONOFORO ALTO
HIGHER WASH SPOUT



7705/26 pag. 175

BOCCA LAVABO C/ATTACCO A PAVIMENTO
FLOOR WASH SPOUT

BIDET



7705/7/S pag. 175

MISCELATORE LAVABO/BIDET MONOFORO
BASIN/BIDET MIXER



7721/E + 104018 pag. 175

MISCELATORE INCASSO
BUILT-IN MIXER



parti esterne / external parts: 7721/E
parte incasso / built-in part: 104018



7700/E + 104002 pag. 175

MISCELATORE INCASSO C/DEVIATORE 2 USCITE
BUILT-IN MIXER WITH DIVERTER 2 OUT



parti esterne / external parts: 7700/E
parte incasso / built-in part: 104002

DOCCIA INCASSO

DEVIATORI INCASSO



7703/2/1/E + 914016 pag. 176

DEVIATORE INCASSO 2 USCITE
BUILT-IN DIVERTER 2 OUT



parti esterne / external parts: 7703/2/1/E
parte incasso / built-in part: 914016



7703/3/1/E + 034127 pag. 176

DEVIATORE INCASSO 3 USCITE
BUILT-IN DIVERTER 3 OUT



parti esterne / external parts: 7703/3/1/E
parte incasso / built-in part: 034127



7703/4/1/E + 034128 pag. 176

DEVIATORE INCASSO 4 USCITE
BUILT-IN DIVERTER 4 OUT



parti esterne / external parts: 7703/4/1/E
parte incasso / built-in part: 034128

DOCCIA INCASSO TERMOSTATICO



0912/H/P/E + 484020 pag. 212*

MISCELATORE TERMOSTATICO INCASSO 1 USCITA
BUILT-IN THERMOSTATIC MIXER 1 OUT

parti esterne / external parts: 0912/H/P/E
parte incasso / built-in part: 484020



0912/2/P/E + 484021 pag. 212*

MISCELATORE TERMOSTATICO INCASSO
C/DEVIATORE 2 USCITE
BUILT-IN THERMOSTATIC MIXER WITH DIVERTER
2 OUT

parti esterne / external parts: 0912/2/P/E
parte incasso / built-in part: 484021



0912/3/P/E + 484022 pag. 212*

MISCELATORE TERMOSTATICO INCASSO
C/DEVIATORE 3 USCITE
BUILT-IN THERMOSTATIC MIXER WITH DIVERTER 3
OUT

parti esterne / external parts: 0912/3/P/E
parte incasso / built-in part: 484022



0912/4/P/E + 484023 pag. 212*

MISCELATORE TERMOSTATICO INCASSO
C/DEVIATORE 4 USCITE
BUILT-IN THERMOSTATIC MIXER WITH DIVERTER
4 OUT

parti esterne / external parts: 0912/4/P/E
parte incasso / built-in part: 484023

DOCCIA ESTERNO



7709/1 pag. 176

MISCELATORE DOCCIA ESTERNO
EXTERNAL SHOWER MIXER



7709/4 pag. 177

MISCELATORE DOCCIA ESTERNO C/STELO
EXTERNAL SHOWER MIXER WITH PIPE



7709/5/1 pag. 177

MISCELATORE DOCCIA ESTERNO C/STELO
COMPLETO
EXTERNAL SHOWER MIXER WITH PIPE

DOCCIA COMPLEMENTI



7503/1/A pag. 136*

SUPPORTO DOCCIA COMPLETO
FULL SHOWER SUPPORT



7503/1 pag. 137*

SUPPORTO DOCCIA DUPLEX COMPLETO
FULL SHOWER SUPPORT WITH DUPLEX



7730 pag. 144*

SALISCENDI COMPLETO C/PRESA D'ACQUA
COMPLETE WALL PIPE WITH WATER CONNECTION



7730/1 pag. 148*

ASTA SALISCENDI
WALL PIPE

* ABBINAMENTO CONSIGLIATO: PER PREZZI E SCHEDE TECNICHE, VEDI RIFERIMENTO PAGINA LISTINO REVIVRE

* RECOMMENDED COMBINATION: FOR PRICES AND TECHNICAL DETAILS, LOOK AT PAGE WITH REFERENCE REVIVRE PRICE



DOCCIA COMPLEMENTI



6513/4 pag. 150*
STELO DOCCIA
ROD SHOWER



7513/5/1 pag. 152*
CURVA PRESA ACQUA C/STELO COMPLETO
CURVE WATER CONNECTOR WITH COMPLETE ROD

VASCA



7701/A pag. 177
MISCELATORE VASCA ESTERNO
EXTERNAL SHOWER MIXER



7701/2/A pag. 177
MISCELATORE PER BORDO VASCA
BATH RIM MIXER



7701/2/P/A pag. 177
MISCELATORE PER BORDO VASCA C/PIASTRA
BATH RIM MIXER ON PLATE



7701/20/A pag. 178
MISCELATORE PER BORDO VASCA S/BOCCA
BATH RIM MIXER WITHOUT SPOUT



7701/20/P/A pag. 178
MISCELATORE PER BORDO VASCA C/PIASTRA S/BOCCA
BATH RIM MIXER WITHOUT SPOUT ON PLATE



7701/4A/E + 734012 pag. 178
MISCELATORE VASCA C/ATTACCHI A PAVIMENTO
FLOOR BATH MIXER

parti esterne / external parts: 7701/4A/E
 parte incasso / built-in part: 734012



7703 pag. 178
BOCCA VASCA DA PARETE
WALL BATH SPOUT



7703/AP/E + 774012 pag. 178
BOCCA VASCA DA PARETE HP
BUILT-IN WALL BATH SPOUT HIGH FLOW RATE



parti esterne / external parts: 7703/AP/E
 parte incasso / built-in part: 774012



7701/26 pag. 179
BOCCA VASCA DA PAVIMENTO
FLOOR BATH SPOUT

BAGNO COMPLEMENTI



7708/E + 054025 pag. 179
RUBINETTO D'ARRESTO 1/2"
BUILT-IN STOP COCK 1/2"



parti esterne / external parts: 7708/E
 parte incasso / built-in part: 054025 DX



7708/E + 054027 pag. 179
RUBINETTO D'ARRESTO 3/4"
BUILT-IN STOP COCK 3/4"



parti esterne / external parts: 7708/E
 parte incasso / built-in part: 054027 DX



7740/E + 884053 | 884054 pag. 179
PASSO RAPIDO 3/4" | 1"
BUILT-IN RAPID FLOW COCK 3/4" | 1"



parti esterne / external parts: 7740/E
 parte incasso / built-in part: 884053 (3/4") | 884054 (1")



7732/2/E + 035212 pag. 180
SARACINESCA
GATE VALVE



parti esterne / external parts: 7732/2/E
 parte incasso / built-in part: 035212



7705/7/S

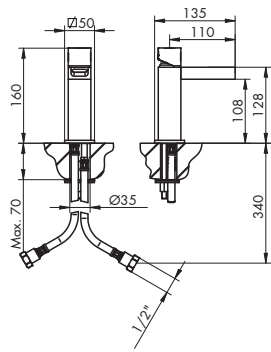

MISCELATORE LAVABO/BIDET MONOFORO

- > cartuccia tradizionale
- > uscita libera a cascata
- > interasse bocca 110
- > limitatore di portata 3l/min 3bar per ingresso
- > flessibili di alimentazione
- > senza scarico

 **6536 - 6536/1**
p. 720

 **444021**
p. 150

CROMATO

01-7705/7/S

ALTRE FINITURE

XX-7705/7/S

x M*

7705/P/S

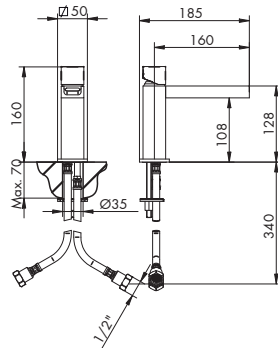

MIX LAVABO MONOFORO BOCCA PROLUNGATA

- > cartuccia tradizionale
- > uscita libera a cascata
- > interasse bocca 160
- > limitatore di portata 3l/min 3bar per ingresso
- > flessibili di alimentazione
- > senza scarico

 **6536 - 6536/1**
p. 720

 **444021**
p. 150

CROMATO

01-7705/P/S

ALTRE FINITURE

XX-7705/P/S

x M*

774001

774002

774003

PROLUNGHE MISCELATORE LAVABO

- > quadro 38 mm
- > altezza 50 mm, 100 mm, 150 mm

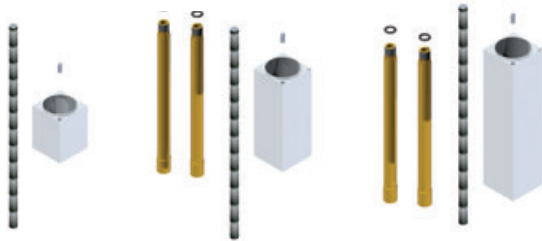

CROMATO

01-774001 50 mm
01-774002 100 mm
01-774003 150 mm

ALTRE FINITURE

XX-774001 50 mm x M*
XX-774002 100 mm x M*
XX-774003 150 mm x M*

7705/3/E + 774057

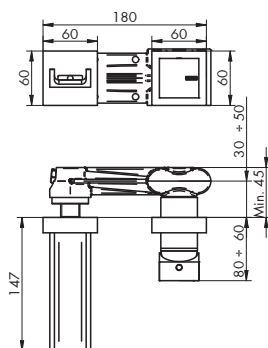

MISCELATORE LAVABO DA PARETE

- > cartuccia tradizionale
- > uscita libera a cascata
- > interasse bocca 147
- > limitatore di portata 5 l/min 3bar sulla bocca
- > ingressi da 1/2"
- > senza scarico
- > rosoni separati

 **6536 - 6536/1**
p. 720

 **025002**
p. 149

PARTI ESTERNE - CROMATO

01-7705/3/E

PARTI ESTERNE - ALTRE FINITURE

XX-7705/3/E

x M*

PARTE INCASSO

01-774057 info pag. 33

PREZZO TOTALE

7705/3/A/E + 884069

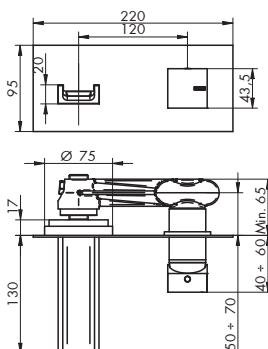

MISCELATORE LAVABO DA PARETE SU PIASTRA

- > cartuccia tradizionale
- > uscita libera a cascata
- > interasse bocca 130
- > limitatore di portata 5 l/min 3bar sulla bocca
- > ingressi da 1/2"
- > senza scarico
- > piastra unica

 **6536 - 6536/1**
p. 720

 **025002**
p. 149

PARTI ESTERNE - CROMATO

01-7705/3/A/E

PARTI ESTERNE - ALTRE FINITURE

XX-7705/3/A/E

x M*

PARTE INCASSO

01-884069 info pag. 34

PREZZO TOTALE

ACCESSORI

 SCARICO C/TAPPO A PRESSIONE

RICAMBI IMMEDIATI

 CARTUCCIA

XX = CODICE FINITURA RICHIESTA: per identificare codice corretto vedi pag. 168
M* = MOLTIPLICATORE: per calcolare il prezzo delle altre finiture vedi tabella pag. 168

7705/PST/E + 734012

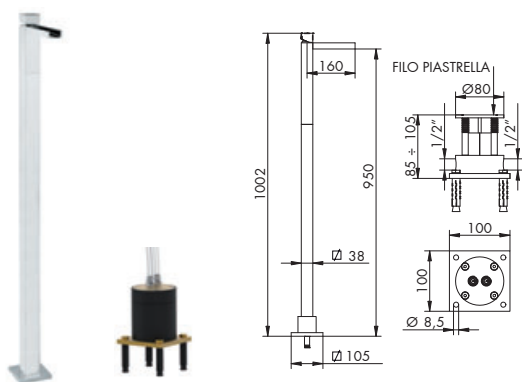

MISCELATORE LAVABO C/ATTACCHI A PAVIMENTO

- > cartuccia tradizionale
- > uscita libera a cascata
- > interasse bocca 160
- > limitatore di portata 3 l/min 3bar per ingresso
- > ingressi da 1/2"
- > senza scarico

 6536 - 6536/1

p. 720

 444021

p. 150

PARTI ESTERNE - CROMATO

01-7705/PST/E

PARTI ESTERNE - ALTRE FINITURE

XX-7705/PST/E

x M*

PARTE INCASSO

734012 info pag. 34

PREZZO TOTALE

7705/R/A

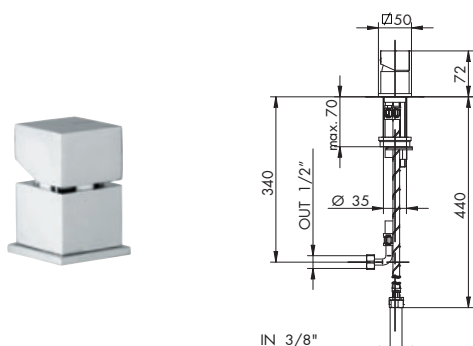

MISCELATORE REMOTO

- > cartuccia tradizionale
- > flessibili di alimentazione
- > senza scarico

 6536 - 6536/1

p. 720

 025002

p. 149

CROMATO

01-7705/R/A

ALTRE FINITURE

XX-7705/R/A

x M*

7705/R/B/E + 104033

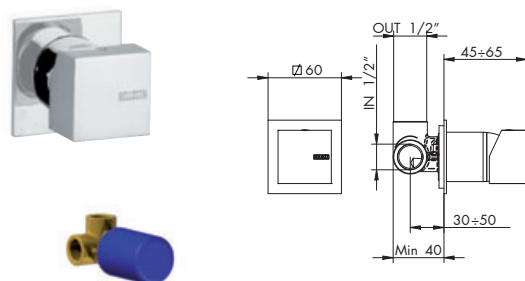

MISCELATORE INCASSO REMOTO

- > cartuccia tradizionale
- > ingressi da 1/2"
- > uscita superiore
- > senza scarico

 6536 - 6536/1

p. 720

 025002

p. 149

PARTI ESTERNE - CROMATO

01-7705/R/B/E

PARTI ESTERNE - ALTRE FINITURE

XX-7705/R/B/E

x M*

PARTE INCASSO

01-104033 info pag. 32

PREZZO TOTALE

7705/1/A

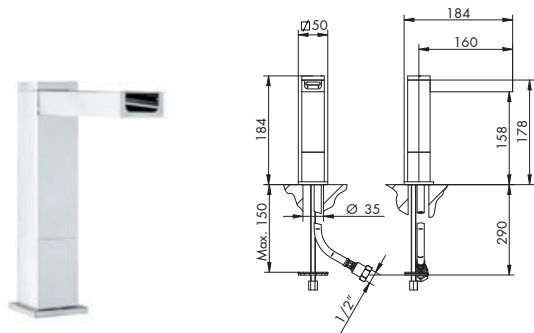

BOCCA LAVABO MONOFORO

- > uscita libera a cascata
- > interasse bocca 160
- > limitatore di portata 5l/min 3bar
- > flessibili di alimentazione
- > senza scarico

 6536 - 6536/1

p. 720

CROMATO

01-7705/1/A

ALTRE FINITURE

XX-7705/1/A

x M*

7705/1/B

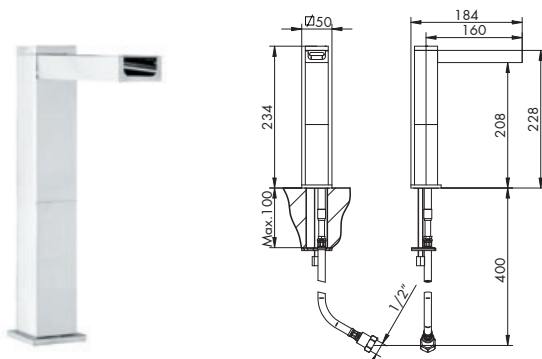

BOCCA LAVABO MONOFORO MEDIUM

- > uscita libera a cascata
- > interasse bocca 160
- > limitatore di portata 5l/min 5bar
- > flessibili di alimentazione
- > senza scarico

 6536 - 6536/1

p. 720

CROMATO

01-7705/1/B

ALTRE FINITURE

XX-7705/1/B

x M*

7705/1/C

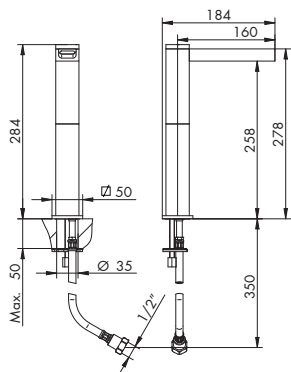

BOCCA LAVABO MONOFORO ALTO

- > uscita libera a cascata
- > interasse bocca 160
- > limitatore di portata 5l/min 3bar
- > flessibili di alimentazione
- > senza scarico

6536 - 6536/1
p. 720

CROMATO

01-7705/1/C

ALTRE FINITURE

XX-7705/1/C

x M*

7705/26

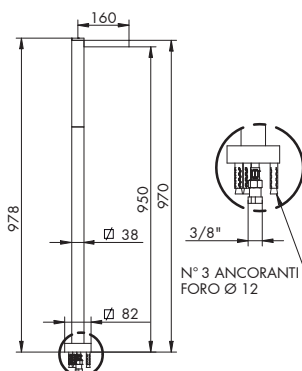

BOCCA LAVABO CON ATTACCO A PAVIMENTO

- > uscita libera a cascata
- > interasse bocca 160
- > altezza d'erogazione 950
- > limitatore di portata 5l/min 3bar
- > attacchi da 3/8"
- > senza scarico

6536 - 6536/1
p. 720

CROMATO

01-7705/26

ALTRE FINITURE

XX-7705/26

x M*

7705/7/S

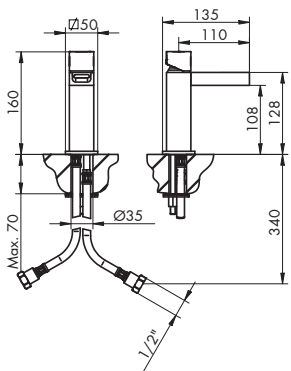

MISCELATORE LAVABO/BIDET MONOFORO

- > cartuccia tradizionale
- > uscita libera a cascata
- > interasse bocca 110
- > limitatore di portata 3l/min 3bar per ingresso
- > flessibili di alimentazione
- > senza scarico

6536 - 6536/1
p. 720444021
p. 150

CROMATO

01-7705/7/S

ALTRE FINITURE

XX-7705/7/S

x M*

7721/E + 104018

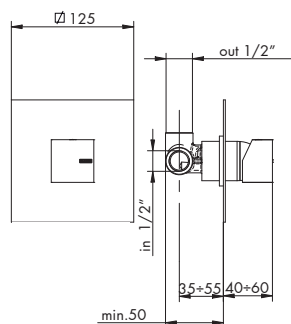

MISCELATORE INCASSO

- > cartuccia tradizionale
- > ingressi da 1/2"
- > uscita superiore
- > incasso c/b-box

025002
p. 149

PARTI ESTERNE - CROMATO

01-7721/E

PARTI ESTERNE - ALTRE FINITURE

XX-7721/E

x M*

PARTE INCASSO

01-104018 info pag. 36

PREZZO TOTALE

7700/E + 104002

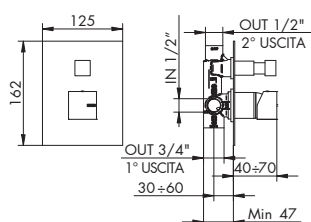

MISCELATORE INCASSO C/DEVIATORE 2 USCITE

- > cartuccia tradizionale
- > deviatore a pressione 2 uscite c/ritorno automatico e blocco meccanico basse pressioni
- > attacchi da 1/2"
- > uscita principale inferiore da 3/4"
- > incasso c/b-box

025002
p. 149105029
p. 131

PARTI ESTERNE - CROMATO

01-7700/E

PARTI ESTERNE - ALTRE FINITURE

XX-7700/E

x M*

PARTE INCASSO

01-104002 info pag. 37

PREZZO TOTALE

ACCESSORI

SCARICO C/TAPPO
A PRESSIONE

RICAMBI IMMEDIATI



CARTUCCIA



DEVIATORE

XX = CODICE FINITURA RICHIESTA: per identificare codice corretto vedi pag. 168
M* = MOLTIPLICATORE: per calcolare il prezzo delle altre finiture vedi tabella pag. 168

7703/2/1/E + 914016

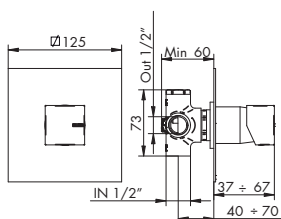

DEVIATORE INCASSO 2 USCITE

> deviatore a dischi ceramici 2 uscite senza chiusura
> attacchi da 1/2"

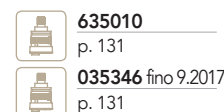

PARTI ESTERNE - CROMATO	
01-7703/2/1/E	
PARTE INCASSO	
914016	info pag. 38
PREZZO TOTALE	

PARTI ESTERNE - ALTRE FINITURE	
XX-7703/2/1/E	x M*

7703/3/1/E + 034127

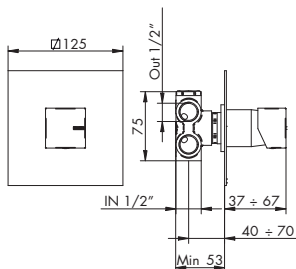

DEVIATORE INCASSO 3 USCITE

> deviatore a dischi ceramici 3 uscite senza chiusura
> attacchi da 1/2"

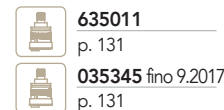

PARTI ESTERNE - CROMATO	
01-7703/3/1/E	
PARTE INCASSO	
034127	info pag. 38
PREZZO TOTALE	

PARTI ESTERNE - ALTRE FINITURE	
XX-7703/3/1/E	x M*

7703/4/1/E + 034128

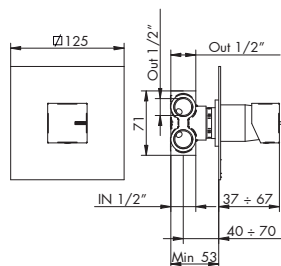

DEVIATORE INCASSO 4 USCITE

> deviatore a dischi ceramici 4 uscite senza chiusura
> attacchi da 1/2"

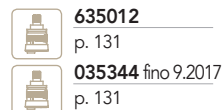

PARTI ESTERNE - CROMATO	
01-7703/4/1/E	
PARTE INCASSO	
034128	info pag. 38
PREZZO TOTALE	

PARTI ESTERNE - ALTRE FINITURE	
XX-7703/4/1/E	x M*

I DOCCIA INCASSO TERMOSTATICO CONSIGLIATI SONO PRESENTI SU LISTINO REVIVRE

- 0912/H/P/E + 484020
- 0912/2/P/E + 484021
- 0912/3/P/E + 484022
- 0912/4/P/E + 484023

I DOCCIA COMPLEMENTI CONSIGLIATI SONO PRESENTI SU LISTINO REVIVRE

- 7503/1/A 6513/4
- 7503/1 7513/5/1
- 7730
- 7730/1

7709/1

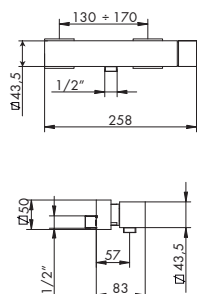

MISCELATORE DOCCIA ESTERNO

> cartuccia tradizionale
> senza set doccia
> attacchi da 1/2"



CROMATO	
01-7709/1	

ALTRE FINITURE	
XX-7709/1	x M*

7709/4

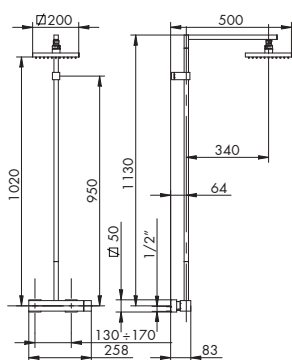

MISCELATORE DOCCIA ESTERNO C/STELO

- > cartuccia tradizionale
- > stelo quadro fisso
- > soffione orientabile 200x200 in ABS con anticalcare
- > ingresso inferiore da 1/2"
- > per finiture diverse da cromo soffione in metallo

025002
p. 149

CROMATO

01-7709/4

ALTRE FINITURE

XX-7709/4

x M*

7709/5/1

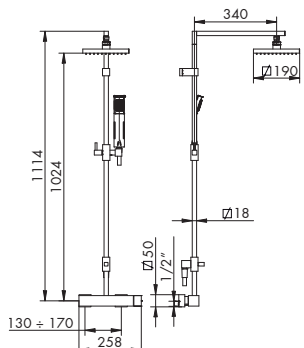

MISCELATORE DOCCIA ESTERNO C/STELO COMPLETO

- > cartuccia tradizionale
- > stelo quadro fisso
- > deviatore a trazione con ritorno automatico e blocco meccanico per basse pressioni
- > soffione orientabile 200x200 in ABS c/anticalcare
- > flessibile PVC L 150 cm
- > presa acqua inferiore da 1/2"
- > doccetta monogetto rettangolare in ABS c/anticalcare, per finiture diverse da cromo doccetta quadra e soffione in metallo

025002
p. 149655070
p. 213

CROMATO

01-7709/5/1

ALTRE FINITURE

XX-7709/5/1

x M*

7701/A

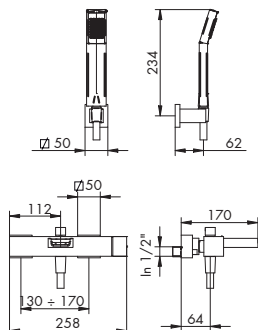

MISCELATORE VASCA ESTERNO

- > cartuccia tradizionale
- > bocca con uscita acqua a 170 mm da muro
- > uscita libera a cascata
- > limitatore di portata 3l/min 3bar per ingresso
- > deviatore manuale con ritorno automatico
- > flessibile in PVC 150 cm
- > gancio fisso a parete > attacchi da 1/2"
- > doccetta monogetto rettangolare in ABS c/anticalcare, per finiture diverse da cromo doccetta quadra e soffione in metallo

025002
p. 149754009
p. 132

CROMATO

01-7701/A

ALTRE FINITURE

XX-7701/A

x M*

7701/2/A

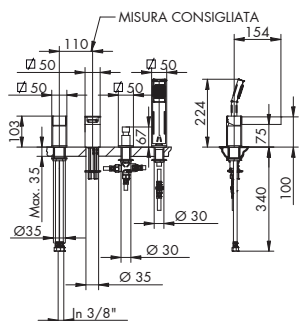

MISCELATORE PER BORDO VASCA

- > cartuccia tradizionale
- > uscita libera a cascata > Interasse bocca 154
- > limitatore di portata 3l/min 3bar per ingresso
- > deviatore a pressione c/ritorno automatico e blocco meccanico basse pressioni
- > flessibile in PVC 150 cm > flessibili di alimentazione senza scarico
- > doccetta monogetto rettangolare in ABS c/anticalcare, per finiture diverse da cromo doccetta quadra e soffione in metallo
- > PREDISPOSIZIONI per bordo vasca, art. 012/4, 012/6 e 012/7, vedi pag. 615

025002
p. 149724030
p. 132

CROMATO

01-7701/2/A

ALTRE FINITURE

XX-7701/2/A

x M*

7701/2/P/A

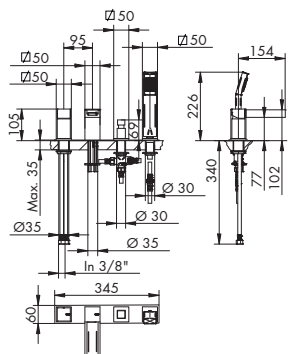

MISCELATORE PER BORDO VASCA

- > cartuccia tradizionale
- > uscita libera a cascata
- > limitatore di portata 3l/min 3bar per ingresso
- > Interasse bocca 154
- > deviatore a pressione c/ritorno automatico e blocco meccanico basse pressioni
- > flessibile in PVC 150 cm > flessibili di alimentazione senza scarico > piastra estetica interasse fori 95mm
- > doccetta monogetto rettangolare in ABS c/anticalcare, per finiture diverse da cromo doccetta quadra e soffione in metallo

025002
p. 149724030
p. 132

CROMATO

01-7701/2/P/A

ALTRE FINITURE

XX-7701/2/P/A

x M*

7701/20/A

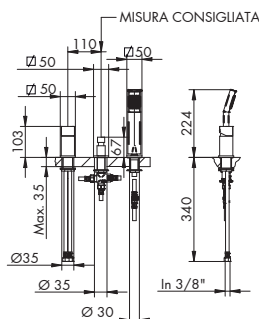

MISCELATORE PER BORDO VASCA S/BOCCA

- > cartuccia tradizionale
- > senza bocca
- > deviatore a pressione c/ritorno automatico e blocco meccanico basse pressioni
- > flessibile in PVC 150 cm
- > flessibili di alimentazione
- > senza scarico
- > doccetta monogetto rettangolare in ABS c/anticalcare, per finiture diverse da cromo doccetta quadra e soffione in metallo
- > PREDISPOSIZIONI per bordo vasca, art. 012/3, 012/6 e 012/7, vedi pag. 615

	025002
	p. 149
	724030
	p. 132

CROMATO	ALTRE FINITURE
01-7701/20/A	XX-7701/20/A x M*

7701/20/P/A

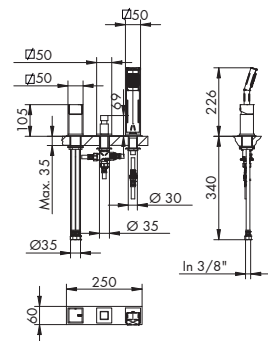

MISCELATORE PER BORDO VASCA C/PIASTRA S/BOCCA

- > cartuccia tradizionale
- > senza bocca
- > deviatore a pressione c/ritorno automatico e blocco meccanico basse pressioni
- > flessibile in PVC 150 cm
- > flessibili di alimentazione
- > senza scarico
- > piastra estetica interasse fori 95mm
- > doccetta monogetto rettangolare in ABS c/anticalcare, per finiture diverse da cromo doccetta quadra e soffione in metallo

	025002
	p. 149
	724030
	p. 132

CROMATO	ALTRE FINITURE
01-7701/20/P/A	XX-7701/20/P/A x M*

7701/4A/E + 734012

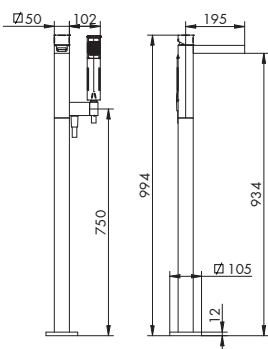

MISCELATORE VASCA C/ATTACCHI A PAVIMENTO

- > cartuccia tradizionale
- > uscita libera a cascata > interasse bocca 195
- > deviatore a dischi ceramici a 2 uscite
- > limitatore di portata
- > flessibile PVC da 150 cm > gancio incorporato
- > senza scarico > parte incasso attacchi da 1/2"
- > doccetta monogetto rettangolare in ABS c/anticalcare, per finiture diverse da cromo doccetta quadra e soffione in metallo

	025002
	p. 149
	755058
	p. 132

PARTI ESTERNE - CROMATO	PARTI ESTERNE - ALTRE FINITURE
01-7701/4A/E	XX-7701/4A/E x M*
PARTE INCASSO	
734012	info pag. 34
PREZZO TOTALE	

7703

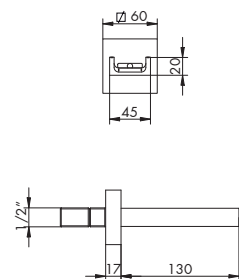
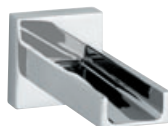

BOCCA VASCA DA PARETE

- > uscita libera a cascata
- > limitatore di portata 5 l/min 3bar sulla bocca
- > interasse bocca 147
- > attacchi da 1/2"

CROMATO	ALTRE FINITURE
01-7703	XX-7703 x M*

7703/AP/E + 774012

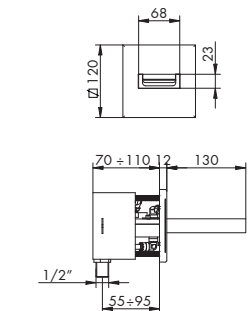

BOCCA VASCA DA PARETE HP

- > uscita libera a cascata
- > interasse bocca 142
- > attacchi da 1/2"
- > portata maggiorata

PARTI ESTERNE - CROMATO	PARTI ESTERNE - ALTRE FINITURE
01-7703/AP/E	XX-7703/AP/E x M*
PARTE INCASSO	
01-774012	
PREZZO TOTALE	

7701/26

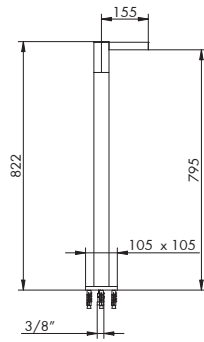

BOCCA VASCA DA PAVIMENTO

- > uscita libera a cascata
- > Interasse bocca 155
- > limitatore di portata 8 lt/min 3 atm
- > senza scarico
- > attacchi da 1/2"

CROMATO

01-7701/26

ALTRE FINITURE

XX-7701/26

x M*

7708/E + 054025 DX

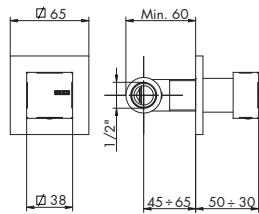

RUBINETTO INCASSO 1/2"

- > vitone ceramico 90°
- > ingressi da 1/2"



055001
p. 151

PARTI ESTERNE - CROMATO

01-7708/E

PARTI ESTERNE - ALTRE FINITURE

XX-7708/E

x M*

PARTE INCASSO

054025 info pag. 40

PREZZO TOTALE

7708/E + 054027 DX

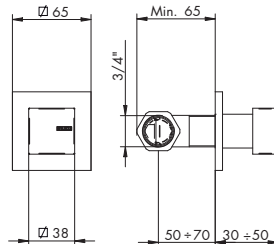

RUBINETTO INCASSO 3/4"

- > vitone ceramico 90°
- > ingressi da 3/4"



055001
p. 151

PARTI ESTERNE - CROMATO

01-7708/E

PARTI ESTERNE - ALTRE FINITURE

XX-7708/E

x M*

PARTE INCASSO

054027 info pag. 40

PREZZO TOTALE

7740/E + 884053

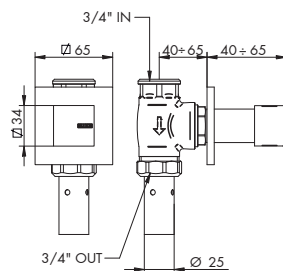

PASSO RAPIDO 3/4"

- > vitone tradizionale
- > abbinare a saracinesca
- > ingressi da 3/4"



884021
p. 151

PARTI ESTERNE - CROMATO

01-7740/E

PARTI ESTERNE - ALTRE FINITURE

XX-7740/E

x M*

PARTE INCASSO

884053 info pag. 42

PREZZO TOTALE

7740/E + 884054

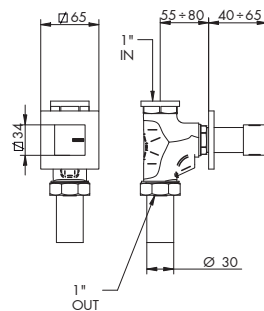

PASSO RAPIDO 1"

- > vitone tradizionale
- > abbinare a saracinesca
- > ingressi da 1"



884021
p. 151

PARTI ESTERNE - CROMATO

01-7740/E

PARTI ESTERNE - ALTRE FINITURE

XX-7740/E

x M*

PARTE INCASSO

884054 info pag. 42

PREZZO TOTALE

RICAMBI IMMEDIATI



XX = CODICE FINITURA RICHIESTA: per identificare codice corretto vedi pag. 168
M* = MOLTIPLICATORE: per calcolare il prezzo delle altre finiture vedi tabella pag. 168

7732/2/E + 035212

SARACINESCA

> attacchi da 3/4"

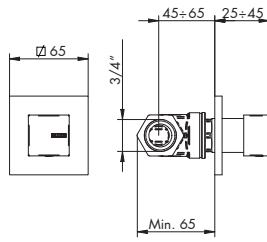

PARTI ESTERNE - CROMATO

01-7732/2/E

PARTE INCASSO

035212 info pag. 42

PREZZO TOTALE

PARTI ESTERNE - ALTRE FINITURE

XX-7732/2/E

x M*



BEETHOVEN

