

split⁰¹

design Antonio Citterio
con Sergio Brioschi



POZZI-GINORI

Sanitec

Pozzi-Ginori fa parte di Sanitec, un gruppo europeo multimarca che progetta, produce e distribuisce ceramiche da bagno e prodotti bath and shower. Il Gruppo riunisce marchi molto conosciuti a livello locale, che hanno una posizione forte e radici profonde nel settore bagno, ed è uno dei leader europei nella fornitura di soluzioni per il bagno.

Sanitec conta circa 8.000 dipendenti, la maggior parte dei quali in Europa. I 25 stabilimenti produttivi sono dislocati sul territorio europeo, mentre la rete vendite e marketing opera a livello mondiale.

Pozzi-Ginori is a part of Sanitec, a European multi-brand group that designs, manufactures and markets bathroom ceramics and bath and shower products. The Group is based on locally well known brands, which have strong positions and deep roots in the bathroom business, and is well positioned as a leading European provider for bathroom solutions.

The Group employs around 8,000 people, mainly in Europe. The 25 production plants are located in Europe whereas the sales and marketing network operates world-wide.



split⁰¹

design Antonio Citterio
con Sergio Brioschi

nuova nelle linee, originale nella concezione. split⁰¹ è la collezione di chiusure doccia che va a completare la ricca gamma d'arredo bagno Pozzi-Ginori. la firma Antonio Citterio nel segno della leggerezza e dell'equilibrio, qualità che si rendono evidenti nei particolari, nella raffinata essenzialità dei profili e nell'elegante funzionalità di cerniere e maniglie.

la collezione si articola in una serie di moduli di varie forme e dimensioni che consentono una naturale integrazione con i diversi ambienti bagno. rimane unica e inimitabile la qualità Pozzi-Ginori, realizzata in un design di trasparente bellezza e praticità d'uso, che apre e chiude allo sguardo l'ambito intimo della doccia. con calcolato effetto di moltiplicazione dello spazio.

new lines, original in conception. split⁰¹ is the shower enclosure collection that completes Pozzi-Ginori's wide range of bathroom fittings and furnishings. designed by Antonio Citterio, the collection is light and well-proportioned; these qualities are particularly noticeable in the details, in the simple elegance of the frames and in the stylish functionality of the hinges and handles. the collection covers a range of modules in various shapes and sizes to match the full spectrum of bathroom styles. Pozzi-Ginori's unique, matchless quality is seen here in a design style of clear beauty and supreme functionality, revealing or concealing our personal shower space. with a calculated effect of spatial expansion.

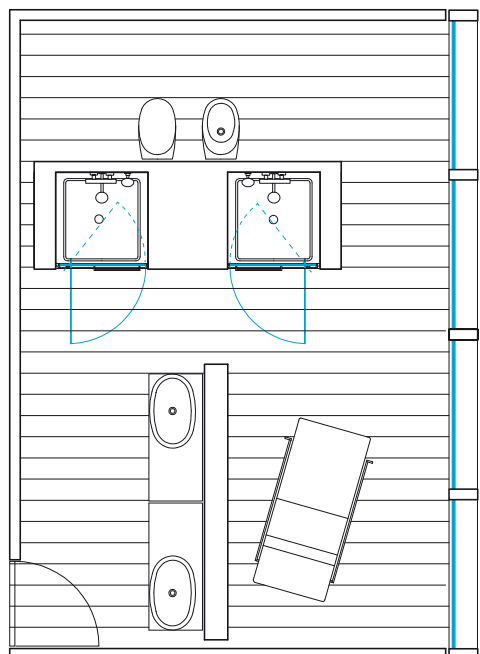

porta pivot 80 destra per
nicchia (70002)
piatto doccia quadrato seventy
80x80 (60183)

pivot door 80 right for a
niche (70002)
seventy square shower tray
80x80 (60183)







porta pivot 140 destra
per nicchia (70052)

pagine precedenti:
porta pivot 140 destra
per nicchia (70052)
porta pivot 140 sinistra
per nicchia (70053)
bidet sospeso serie egg (51256)
vaso sospeso serie egg (51315)
bacinelle da appoggio 60
serie egg (51110)
mobile sospeso 120 in wengè
serie mobili collection (41769-088)
mobile sospeso 120 in wengè
serie mobili collection (41768-088)

**pivot door 140 right
for a niche (70052)**

previous pages:
**pivot door 140 right
for a niche (70052)**
**pivot door 140 left
for a niche (70053)**
egg series wall hung bidet (51256)
**egg series wall hung water
closet (51315)**
**egg series lay-on
washbasins 60 (51110)**
**mobili collection series
wengè wall hung
cabinet 120 (41769-088)**
**mobili collection series
wengè wall hung
cabinet 120 (41768-088)**

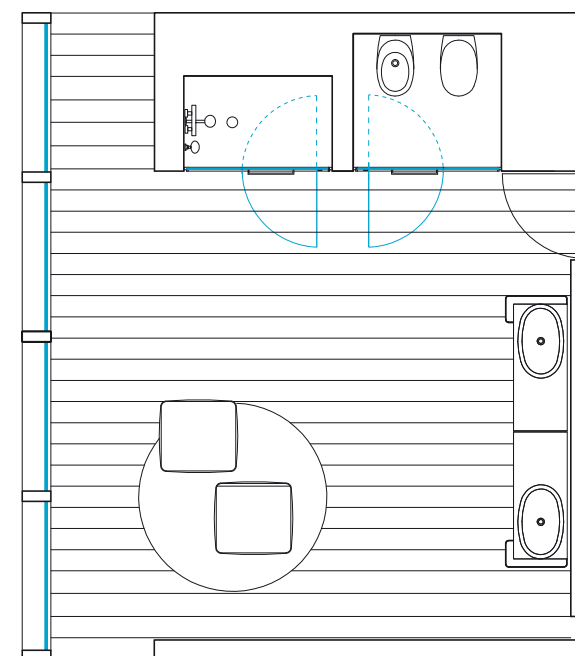





porta pivot 80 destra (70102)
con pannello laterale fisso
80 sinistro (70153)
piatto doccia quadrato
seventy 80x80 (60183)

pivot door 80 right (70102) with
fixed side panel 80 left (70153)
seventy square shower tray
80x80 (60183)

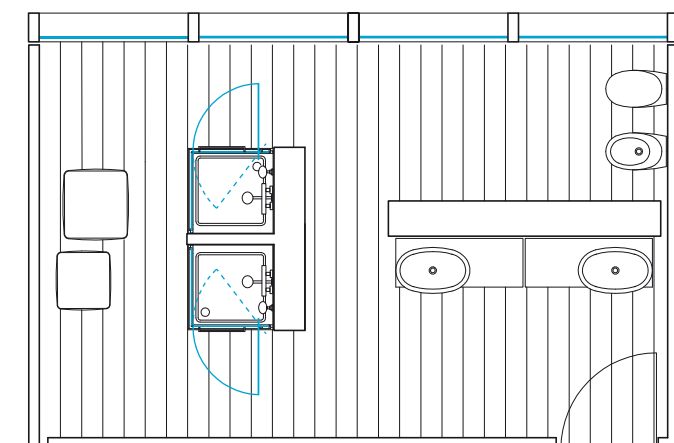





profilo superiore chiusura 120x80
piatto doccia rettangolare
dido 120x80 (60192)

pagine precedenti:
porta pivot 120 destra (70250)
con pannello laterale fisso 80
sinistro (70303)
porta pivot 120 sinistra (70251)
con pannello laterale fisso 80
destro (70302)
piatto doccia rettangolare
dido 120x80 (60192)
bacinelle da appoggio ovali 70
senza piano rubinetteria serie
Q3 (43111)
mobile 120 con cassettera
in essenza mogano
serie Q3 (43855-080)
mobile 120 con cassettera
in essenza mogano
serie Q3 (43854-080)

shower enclosure 120x80 upper
profile dido rectangular shower
tray 120x80 (60192)

previous pages:
pivot door 120 right (70250) with
fixed side panel 80 left (70303)
pivot door 120 left (70251) with
fixed side panel 80 right (70302)
dido rectangular shower tray
120x80 (60192)
Q3 series oval lay-on washbasins
70 without tap-hole (43111)
Q3 series storage solution 120
with set of drawers in mahogany
wood (43855-080)
Q3 series storage solution 120
with set of drawers in mahogany
wood (43854-080)

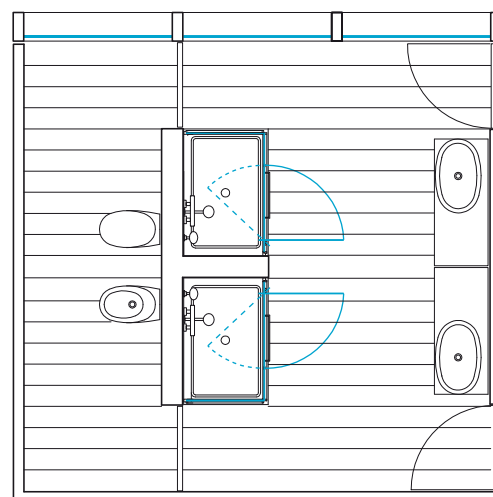

dettaglio profilo
chiusura 120x80

detail of shower
enclosure 120x80





chiusura semicircolare 90
destra (70352)
piatto doccia ground
angolare 90x90

quadrant shower enclosure 90
right (70352)
ground corner shower
tray 90x90





dettaglio chiusura semicircolare
90 destra (70352)
piatto doccia ground
angolare 90x90

detail of shower enclosure
90 right (70352)
ground corner shower
tray 90x90



parete frontale 90 destra (70204)
parete frontale 90 sinistra (70205)
specchio 80x80 in wengè serie
mobili collection (41837-088)
composizione serie
join (04913-085)
vaso sospeso serie join (04318)

shower panel 90 right (70204)
shower panel 90 left (70205)
mobili collection series wengè
mirror 80x80 (41837-088)
join series composition
(04913-085)
join series wall hung
water closet (04318)

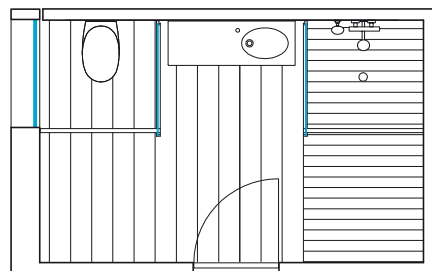



parete frontale 160
sinistra (70213)

pagine precedenti:
parete frontale 160
sinistra (70213)
lavabi 70 serie
novecento (40022)
strutture sottolavabo
in ottone cromato
serie novecento (40800)

shower panel 160
left (70213)

previous pages:
shower panel 160
left (70213)
novecento series
washbasin 70 (40022)
novecento series
chrome-plated brass
structure (40800)

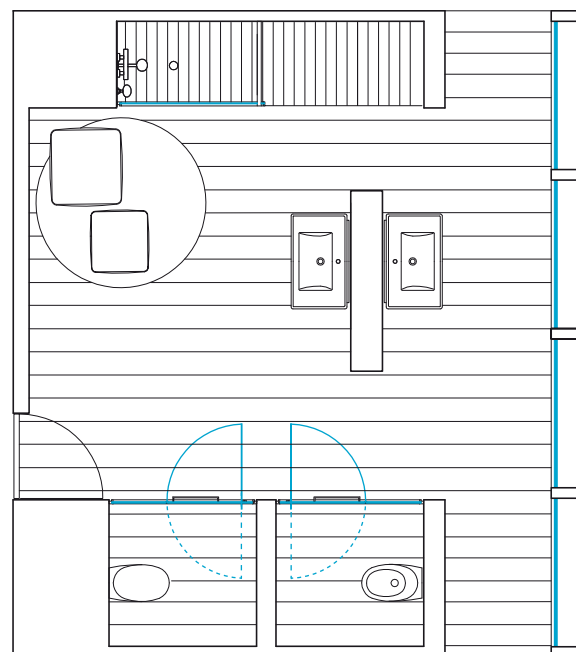



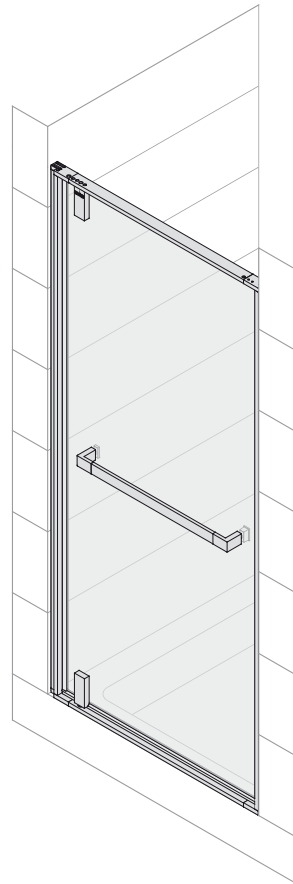

**porta pivot (NPA)
non reversibile**

apertura esterna ed interna
estensibilità: 2,5 cm
cristallo: 6 mm
altezza: 195 cm

**pivot door (NPA)
not reversible**

external and internal opening
adjustability: 2,5 cm
glass: 6 mm
height: 195 cm

* codice code	versione version	dimensione measures	estensibilità adjustability	A-entrata porta A-entry width
70000	dx/r	70	68,5 - 71	approx. 53,3
70001	sx/l	70	68,5 - 71	approx. 53,3
70002	dx/r	80	78,5 - 81	approx. 63,3
70003	sx/l	80	78,5 - 81	approx. 63,3
70004	dx/r	90	88,5 - 91	approx. 73,3
70005	sx/l	90	88,5 - 91	approx. 73,3
70006	dx/r	100	98,5 - 101	approx. 83,3
70007	sx/l	100	98,5 - 101	approx. 83,3

Le misure sono espresse in centimetri (cm)
The measures are in centimeters (cm)

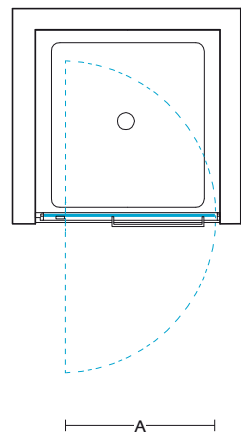

NPA
versione sinistra
left version

* completamento codice - complete code

010

0 cristallo temperato - TRS trasparente - 0 tempered glass - TRS transparent
1 colore profili - ARL argento lucido - 1 profiles colour - SHG silver glossy finish
0 cristallo senza trattamento anticalcare - 0 glass without limescale-proof treatment

011

0 cristallo temperato - TRS trasparente - 0 tempered glass - TRS transparent
1 colore profili - ARL argento lucido - 1 profiles colour - SHG silver glossy finish
1 cristallo con trattamento anticalcare - 1 glass with limescale-proof treatment

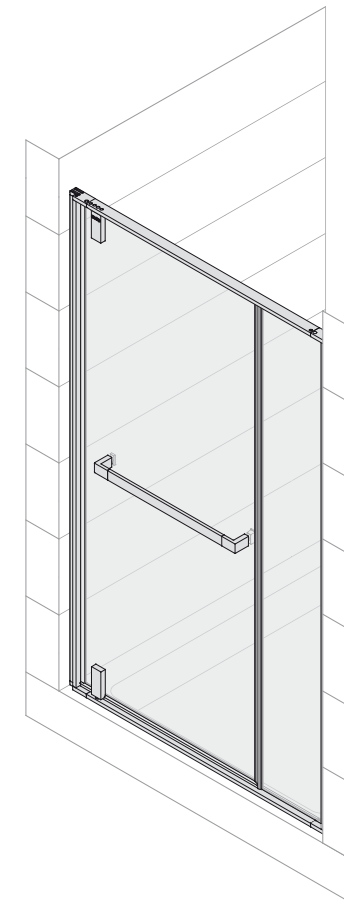

**porta pivot con elemento fisso (NWPA)
non reversibile**

apertura esterna ed interna
estensibilità: 2,5 cm
cristallo: 6 mm
altezza: 195 cm

**pivot door with fixed element (NWPA)
not reversible**

external and internal opening
adjustability: 2,5 cm
glass: 6 mm
height: 195 cm

* codice code	versione version	dimensione measures	estensibilità adjustability	A-entrata porta A-entry width	B-dimensione porta B-door dimension
70050	dx/r	120	117 - 122	approx. 71,3	approx. 82,5
70051	sx/l	120	117 - 122	approx. 71,3	approx. 82,5
70052	dx/r	140	137 - 142	approx. 71,3	approx. 82,5
70053	sx/l	140	137 - 142	approx. 71,3	approx. 82,5
70054	dx/r	160	157 - 162	approx. 71,3	approx. 82,5
70055	sx/l	160	157 - 162	approx. 71,3	approx. 82,5

Le misure sono espresse in centimetri (cm)
The measures are in centimeters (cm)

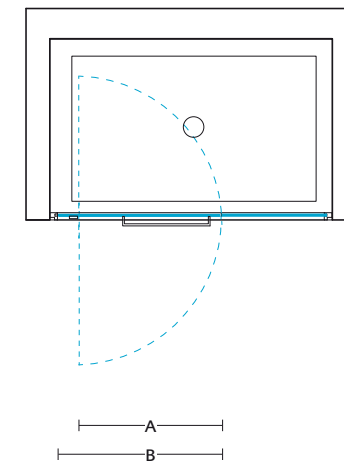

NWPA
versione sinistra
left version

* completamento codice - complete code

010

0 cristallo temperato - TRS trasparente - 0 tempered glass - TRS transparent
1 colore profili - ARL argento lucido - 1 profiles colour - SHG silver glossy finish
0 cristallo senza trattamento anticalcare - 0 glass without limescale-proof treatment

011

0 cristallo temperato - TRS trasparente - 0 tempered glass - TRS transparent
1 colore profili - ARL argento lucido - 1 profiles colour - SHG silver glossy finish
1 cristallo con trattamento anticalcare - 1 glass with limescale-proof treatment



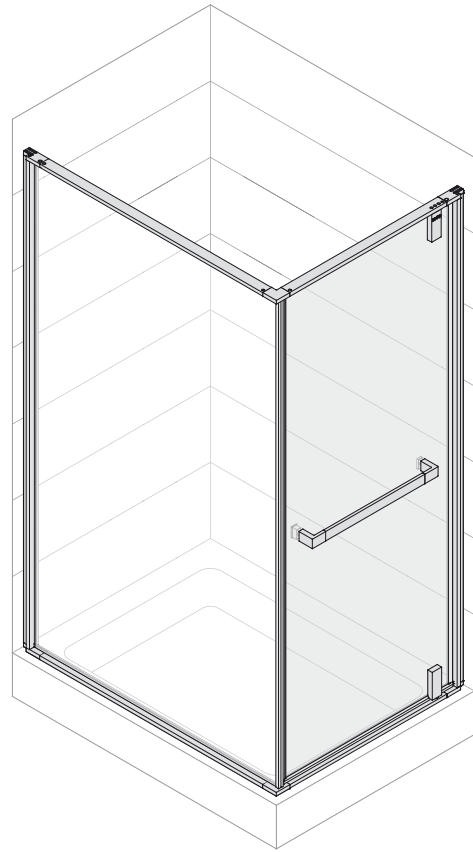

**porta pivot (TPA)
non reversibile**
da completare con pannello laterale fisso (W)
apertura esterna ed interna
estensibilità: 2,5 cm
cristallo: 6 mm
altezza: 195 cm

**pivot door (TPA)
not reversible**
for combination with fixed side panel (W)
external and internal opening
adjustability: 2,5 cm
glass: 6 mm
height: 195 cm

* codice code	versione version	dimensione measures	estensibilità adjustability	A-entrata porta A-entry width
70100	dx/r	70	68 - 70,5	approx. 50,3
70101	sx/l	70	68 - 70,5	approx. 50,3
70102	dx/r	80	78 - 80,5	approx. 60,3
70103	sx/l	80	78 - 80,5	approx. 60,3
70104	dx/r	90	88 - 90,5	approx. 70,3
70105	sx/l	90	88 - 90,5	approx. 70,3
70106	dx/r	100	98 - 100,5	approx. 80,3
70107	sx/l	100	98 - 100,5	approx. 80,3

Le misure sono espresse in centimetri (cm)
The measures are in centimeters (cm)

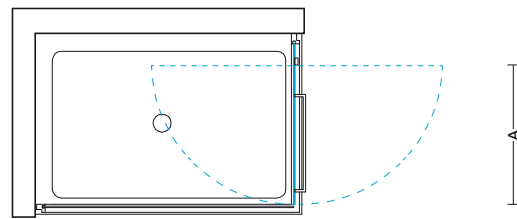

* completamento codice - **complete code**

010
0 cristallo temperato - TRS trasparente - 0 tempered glass - TRS transparent
1 colore profili - ARL argento lucido - 1 profiles colour - SHG silver glossy finish
0 cristallo senza trattamento anticalcare - 0 glass without limescale-proof treatment

011
0 cristallo temperato - TRS trasparente - 0 tempered glass - TRS transparent
1 colore profili - ARL argento lucido - 1 profiles colour - SHG silver glossy finish
1 cristallo con trattamento anticalcare - 1 glass with limescale-proof treatment



TPA
versione destra
right version

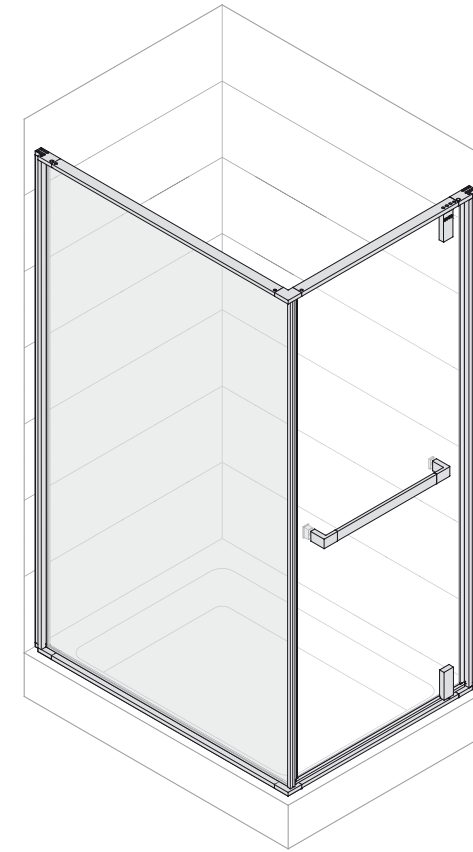

**pannello laterale fisso (W)
non reversibile**
da completare con porta pivot (TPA)
estensibilità: 2,5 cm
cristallo: 6 mm
altezza: 195 cm

**fixed side panel (W)
not reversible**
for combination with a pivot door (TPA)
adjustability: 2,5 cm
glass: 6 mm
height: 195 cm

* codice code	versione version	dimensione measures	estensibilità adjustability
70150	dx/r	70	68 - 70,5
70151	sx/l	70	68 - 70,5
70152	dx/r	80	78 - 80,5
70153	sx/l	80	78 - 80,5
70154	dx/r	90	88 - 90,5
70155	sx/l	90	88 - 90,5
70156	dx/r	100	98 - 100,5
70157	sx/l	100	98 - 100,5
70158	dx/r	120	118 - 120,5
70159	sx/l	120	118 - 120,5
70160	dx/r	140	138 - 140,5
70161	sx/l	140	138 - 140,5
70162	dx/r	160	158 - 160,5
70163	sx/l	160	158 - 160,5

Le misure sono espresse in centimetri (cm)
The measures are in centimeters (cm)

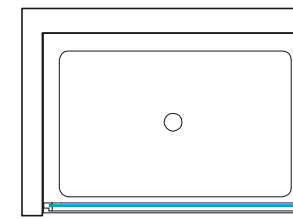

* completamento codice - **complete code**

010
0 cristallo temperato - TRS trasparente - 0 tempered glass - TRS transparent
1 colore profili - ARL argento lucido - 1 profiles colour - SHG silver glossy finish
0 cristallo senza trattamento anticalcare - 0 glass without limescale-proof treatment

011
0 cristallo temperato - TRS trasparente - 0 tempered glass - TRS transparent
1 colore profili - ARL argento lucido - 1 profiles colour - SHG silver glossy finish
1 cristallo con trattamento anticalcare - 1 glass with limescale-proof treatment

W
pannello laterale fisso versione sinistra
left hand version side panel

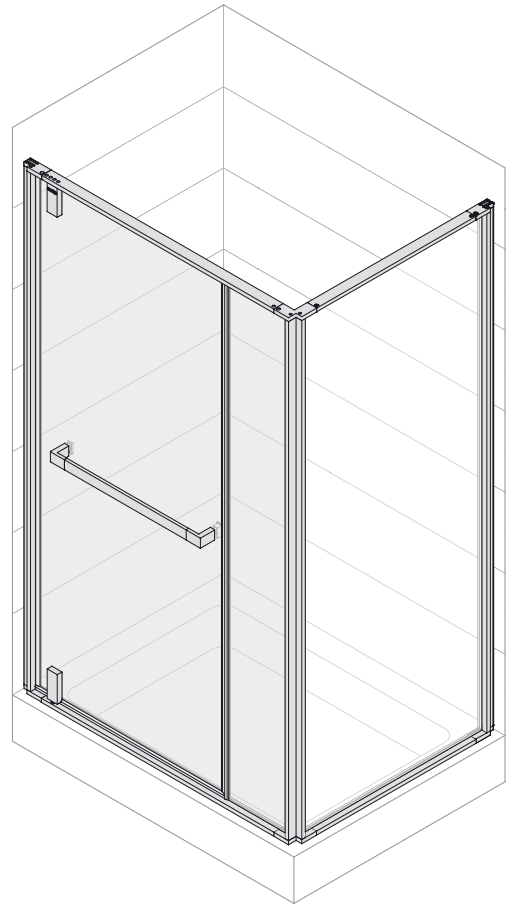

**porta pivot con elemento fisso (TWPA)
non reversibile**

da completare con pannello laterale fisso (WF)
apertura esterna ed interna
estensibilità: 2,5 cm
cristallo: 6 mm
altezza: 195 cm

**pivot door with fixed element (TWPA)
not reversible**

for combination with fixed side panel (WF)
external and internal opening
adjustability: 2,5 cm
glass: 6 mm
height: 195 cm

* codice code	versione version	dimensione measures	estensibilità adjustability	A-entrata porta A-entry width	B-dimensione porta B-door dimension
70250	dx/r	120	118 - 120,5	approx. 70,8	approx. 82,0
70251	sx/l	120	118 - 120,5	approx. 70,8	approx. 82,0
70252	dx/r	140	138 - 140,5	approx. 70,8	approx. 82,0
70253	sx/l	140	138 - 140,5	approx. 70,8	approx. 82,0
70254	dx/r	160	158 - 160,5	approx. 70,8	approx. 82,0
70255	sx/l	160	158 - 160,5	approx. 70,8	approx. 82,0

Le misure sono espresse in centimetri (cm)
The measures are in centimeters (cm)

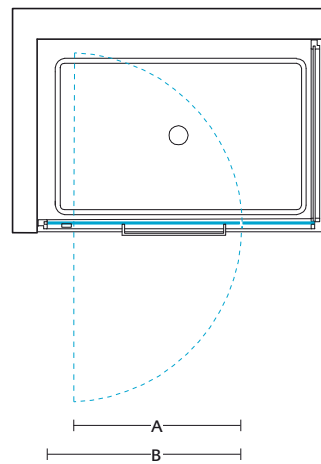

TWPA
versione sinistra
left version

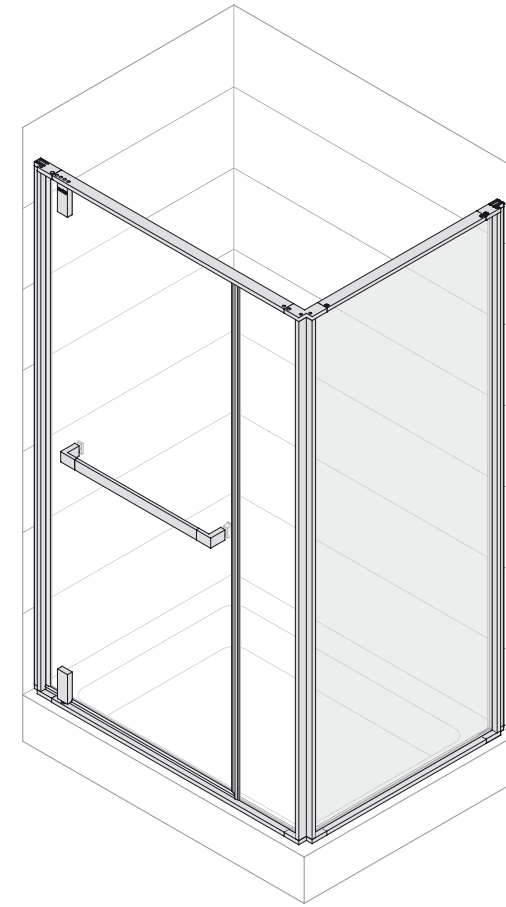

**pannello laterale fisso (WF)
non reversibile**

da completare con porta pivot con elemento fisso (TWPA)
apertura esterna ed interna
estensibilità: 2,5 cm
cristallo: 6 mm
altezza: 195 cm

**fixed side panel (WF)
not reversible**

for combination with a pivot door with fixed element (TWPA)
external and internal opening
adjustability: 2,5 cm
glass: 6 mm
height: 195 cm

* codice code	versione version	dimensione measures	estensibilità adjustability
70300	dx/r	70	68 - 70,5
70301	sx/l	70	68 - 70,5
70302	dx/r	80	78 - 80,5
70303	sx/l	80	78 - 80,5
70304	dx/r	90	88 - 90,5
70305	sx/l	90	88 - 90,5
70306	dx/r	100	98 - 100,5
70307	sx/l	100	98 - 100,5

Le misure sono espresse in centimetri (cm)
The measures are in centimeters (cm)

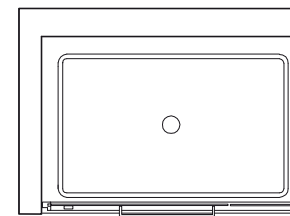

* completamento codice - complete code

- 010**
0 cristallo temperato - TRS trasparente - 0 tempered glass - TRS transparent
1 colore profili - ARL argento lucido - 1 profiles colour - SHG silver glossy finish
0 cristallo senza trattamento anticalcare - 0 glass without limescale-proof treatment
- 011**
0 cristallo temperato - TRS trasparente - 0 tempered glass - TRS transparent
1 colore profili - ARL argento lucido - 1 profiles colour - SHG silver glossy finish
1 cristallo con trattamento anticalcare - 1 glass with limescale-proof treatment



WF
versione destra
right version

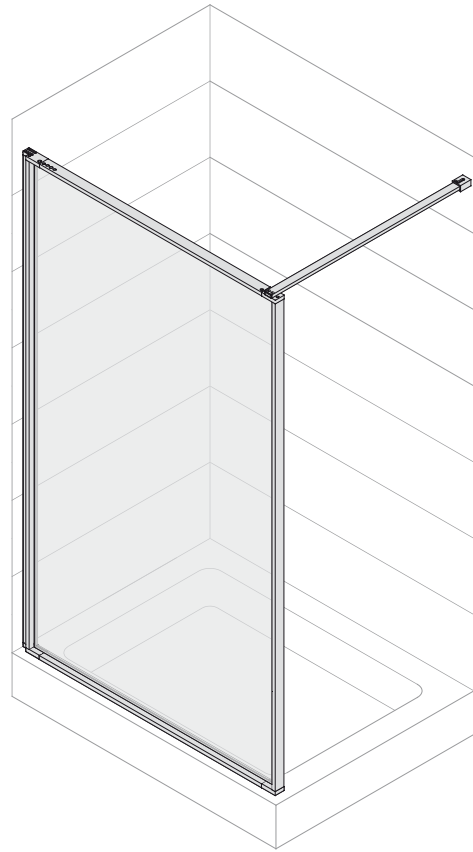

parete frontale (WW)
non reversibile

completa di barra stabilizzatrice
estensibilità: 2,5 cm
cristallo: 6 mm
altezza: 195 cm

shower panel (WW)
not reversible

with stabilization bar
adjustability: 2,5 cm
glass: 6 mm
height: 195 cm

* codice code	versione version	dimensione measures	estensibilità adjustability
70200	dx/r	70	68 - 70,5
70201	sx/l	70	68 - 70,5
70202	dx/r	80	78 - 80,5
70203	sx/l	80	78 - 80,5
70204	dx/r	90	88 - 90,5
70205	sx/l	90	88 - 90,5
70206	dx/r	100	98 - 100,5
70207	sx/l	100	98 - 100,5
70208	dx/r	120	118 - 120,5
70209	sx/l	120	118 - 120,5
70210	dx/r	140	138 - 140,5
70211	sx/l	140	138 - 140,5
70212	dx/r	160	158 - 160,5
70213	sx/l	160	158 - 160,5

Le misure sono espresse in centimetri (cm)
The measures are in centimeters (cm)

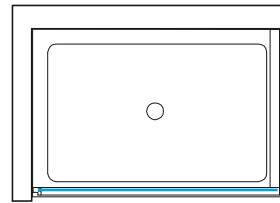

* completamento codice - **complete code**

010

0 cristallo temperato - TRS trasparente - 0 tempered glass - TRS transparent
1 colore profili - ARL argento lucido - 1 profiles colour - SHG silver glossy finish
0 cristallo senza trattamento anticalcare - 0 glass without limescale - proof treatment

011

0 cristallo temperato - TRS trasparente - 0 tempered glass - TRS transparent
1 colore profili - ARL argento lucido - 1 profiles colour - SHG silver glossy finish
1 cristallo con trattamento anticalcare - 1 glass with limescale-proof treatment



WW
versione sinistra
left version

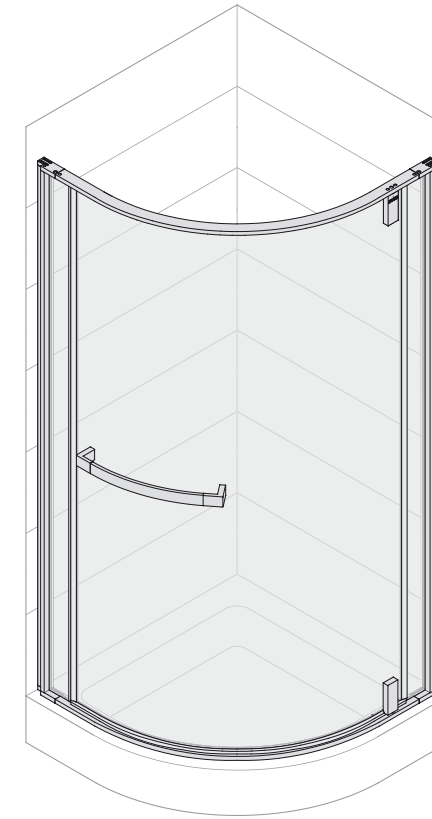

porta pivot semi-circolare con
2 elementi fissi (VFFA)

non reversibile

apertura esterna
estensibilità: 2,5 cm
cristallo: 6 mm
altezza: 195 cm

quadrant pivot door with
2 fixed elements (VFFA)

not reversible

external opening
adjustability: 2,5 cm
glass: 6 mm
height: 195 cm

* codice code	versione version	dimensione measures	estensibilità adjustability	raggio radius	A-entrata porta A-entry width
70350	dx/r	80	78 - 80,5	55	approx. 83,0
70351	sx/l	80	78 - 80,5	55	approx. 83,0
70352	dx/r	90	88 - 90,5	55	approx. 83,0
70353	sx/l	90	88 - 90,5	55	approx. 83,0

Le misure sono espresse in centimetri (cm)
The measures are in centimeters (cm)

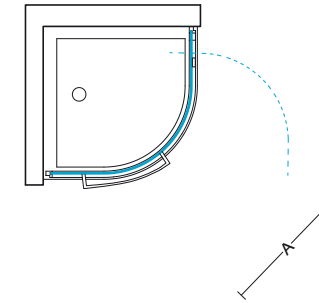

* completamento codice - **complete code**

010

0 cristallo temperato - TRS trasparente - 0 tempered glass - TRS transparent
1 colore profili - ARL argento lucido - 1 profiles colour - SHG silver glossy finish
0 cristallo senza trattamento anticalcare - 0 glass without limescale - proof treatment

011

0 cristallo temperato - TRS trasparente - 0 tempered glass - TRS transparent
1 colore profili - ARL argento lucido - 1 profiles colour - SHG silver glossy finish
1 cristallo con trattamento anticalcare - 1 glass with limescale-proof treatment



VFFA
versione destra
right version

	ground 90x80 100x80 120x80 140x90 160x70	ground 90x90	ground 90x90	dido R120 120x80	dido Q90 90x90	dido A90 90x90	graffio 90x70 100x80 120x80 140x70	graffio 80x80 90x90	graffio 80x80 90x90		seventy 90x72 120x80	seventy 80x80 90x90	seventy 80x80 90x90	reno xp 120x80	nilo xp 90 90x70	nilo 90x72 100x75	nilo 90x75	sangro 90x90	naviglio 80 80x80	abele 90x90
	●	●			●		●	●			●	●			●	●		●	●	●
	●			●			●				●			●						
	●	●		●	●		●	●			●	●		●	●			●	●	●
	●	●		●	●		●	●			●	●		●	●			●	●	●
	●			●			●				●			●						
	●			●			●				●			●						
	●	●		●	●		●	●			●	●		●	●	●	●	●	●	●
			●			●			●					●						

dimensioni su misura

	larghezza (cm)		altezza (cm)	
	min	max	min	max
porta per installazione in nicchia (NPA)	58,5	101	180	210
porta con elemento fisso per installazione in nicchia (NWPA)	102	162	180	210
porta per completamento con pannello laterale (TPA)	58,5	100,5	180	210
pannello laterale fisso per completamento con porta (W)	40	160,5	180	210
porta con elemento fisso per completamento con pannello laterale (TWPA)	102	160,5	180	210
pannello laterale fisso per completamento con porta con elemento fisso (WF)	40	100,5	180	210
parete frontale (WW)	40	160,5	180	210
porta semi-circolare con 2 elementi fissi (VFFA)	78,5	110	-	-

tailor made dimensions

	width (cm)		height (cm)	
	min	max	min	max
door for niche installation (NPA)	58,5	101	180	210
door with fixed element for niche installation (NWPA)	102	162	180	210
door for combination with fixed side panel (TPA)	58,5	100,5	180	210
fixed side panel for combination with door (W)	40	160,5	180	210
door with fixed element for combination with fixed side panel (TWPA)	102	160,5	180	210
fixed side panel for combination with door with fixed element (WF)	40	100,5	180	210
shower panel (WW)	40	160,5	180	210
quadrant door with 2 fixed element (VFFA)	78,5	110	-	-



art direction
antonio citterio
graphic design
porcupine™
styling
ravaiolisilenzistudio
photography
gionata xerra
photo assistants
pierpaolo mazzola
leonardo pelucchi
photo retouching
danilo pasquali
leonardo pelucchi
art buying
bruno tarsia
ilaria gerli

thanks to
atipico
b&b
bonacina pierantonio
bossi
comfort zone
davines
d&m depot
extrahome
ferlea
fabbian
flexform
flos
fiorirà un giardino
gandia blasco
gt design
itama
lineabeta
luceplan
nodus
paola c
society made in limonta
vittorio bonacina



Pozzi-Ginori è storia dell'arte e del design italiani della porcellana da bagno. Le sue origini risalgono al 1735, quando il marchese Carlo Ginori dette inizio, fra i primi in Europa, alla creazione di splendidi manufatti in quel prezioso tipo di ceramica che allora era chiamato "l'oro bianco". La sua Manifattura di Doccia, a nord ovest di Firenze, divenne presto fra le massime d'Europa. Nel tempo, con la Ginori si fusero le altre manifatture ceramiche progressivamente sorte in Italia: prima quella di Giulio Richard, poi la Società Ceramica Italiana di Laveno, quindi la Pozzi. Ognuna di queste, prima da sola, poi integrandosi alle altre, ha segnato le varie tappe della sapienza e della tecnologia italiane nella progettazione e nella realizzazione di prodotti sanitari in porcellana. Con l'iniziare e poi l'affermarsi dei metodi e della prassi dell'industrial design, fin dal 1918 grandi designer hanno contribuito a scandire tali tappe: Giò Ponti, Guido Andlovitz, lo studio Nizzoli, Giovanni Gariboldi, Antonia Campi, Gae Aulenti, Paolo Tilche, Matteo Thun, fra i più noti. Ed ora anche Antonio Citterio. Entrata in Sanitec Group nel 1994, Pozzi-Ginori continua la sua grande tradizione con immutata costante capacità innovativa.

Pozzi-Ginori represents the history of Italian art and design in bathroom ceramics. Its origins date to 1735, when Marquess Carlo Ginori was one of the first people in Europe to begin manufacturing splendid objects in a precious grade of ceramics they used to call "white gold." His Doccia Factory northwest of Florence quickly became one of the largest in Europe. Over time, Ginori merged with other ceramic manufacturers that progressively sprang up in Italy: first, there was Giulio Richard, then the Laveno Italian Ceramic Company, and finally Pozzi. Each manufacturer began on its own, then merging with the others, as they established milestones in Italian technology and expertise in the design and creation of bathroom ceramic products. As the methods and practices of industrial design originated and then asserted themselves, great designers have helped articulate various stages since 1918: Giò Ponti, Guido Andlovitz, the Nizzoli studio, Giovanni Gariboldi, Antonia Campi, Gae Aulenti, Paolo Tilche, and Matteo Thun are some of the better known ones. Now there is Antonio Citterio. After entering the Sanitec Group in 1994, Pozzi-Ginori has continued this grand tradition with its unchanging, constant capacity to innovate.

I dati e le caratteristiche indicate non impegnano la Pozzi-Ginori S.p.A. che si riserva il diritto di apportare delle modifiche ritenute opportune senza obbligo di preavviso e sostituzione.

The data and characteristics indicated in this catalogue do not bind Pozzi-Ginori S.p.A., which reserves the right to make the necessary modifications without notice or product replacement.



Pozzi-Ginori SpA
via Valcellina, n. A2 z.i. nord
33097 Spilimbergo PN Italy
tel +39 0427 594111
fax +39 0427 50304
www.pozzi-ginori.com